

Task 1 of 50 Score = 0.000779014

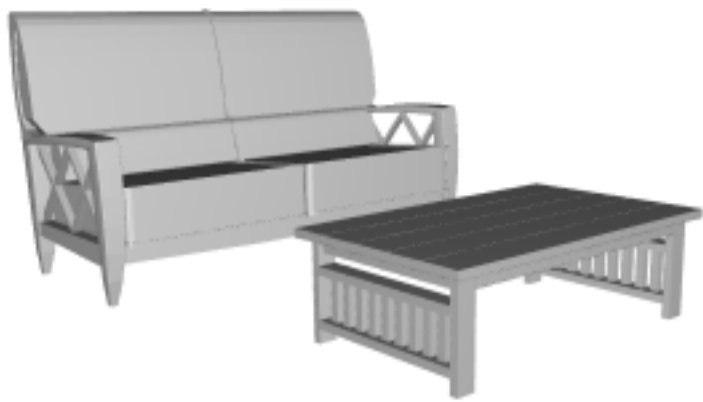

0.909091

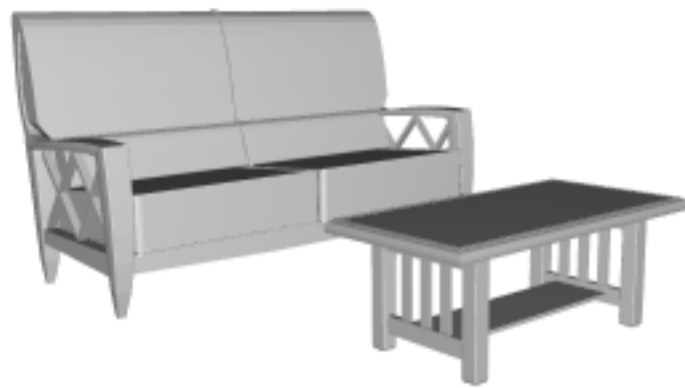

0.727273

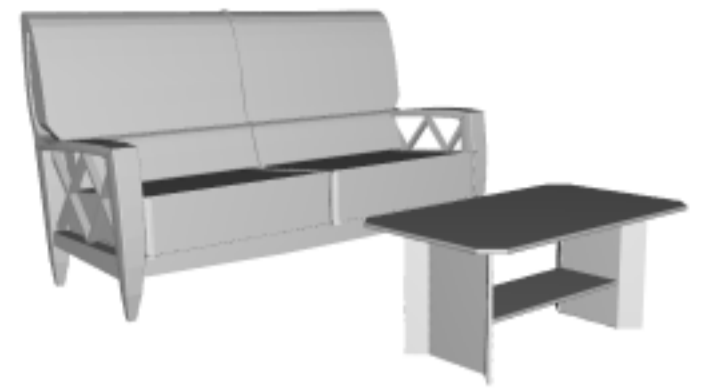

0.0909091

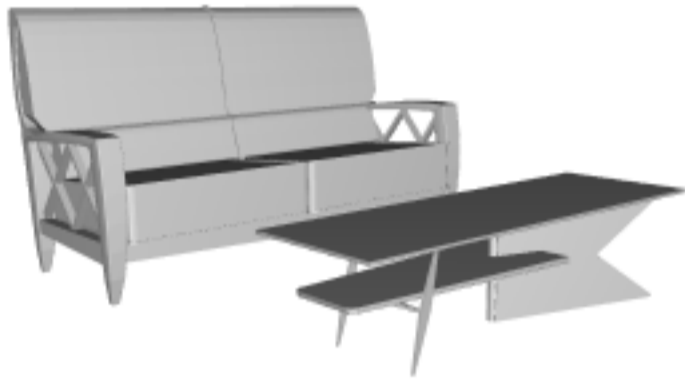

0.0909091

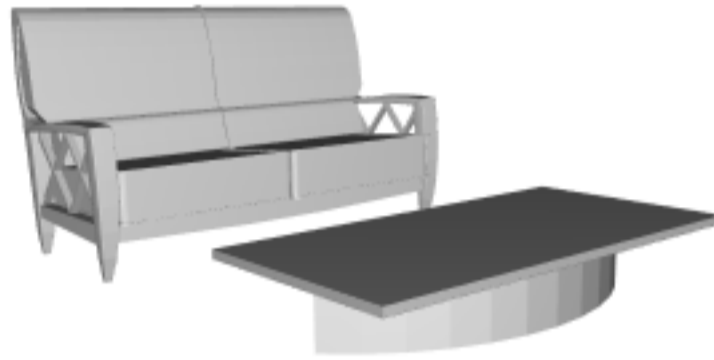

0.0909091

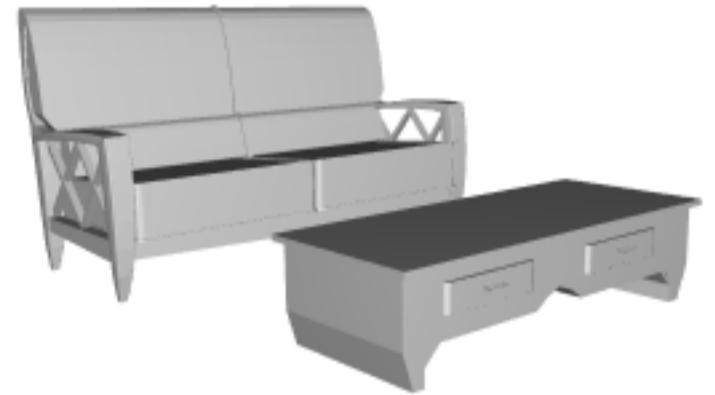

0.0909091

Task 2 of 50 Score = 0.000869396



0.777778



0.444444



0.333333

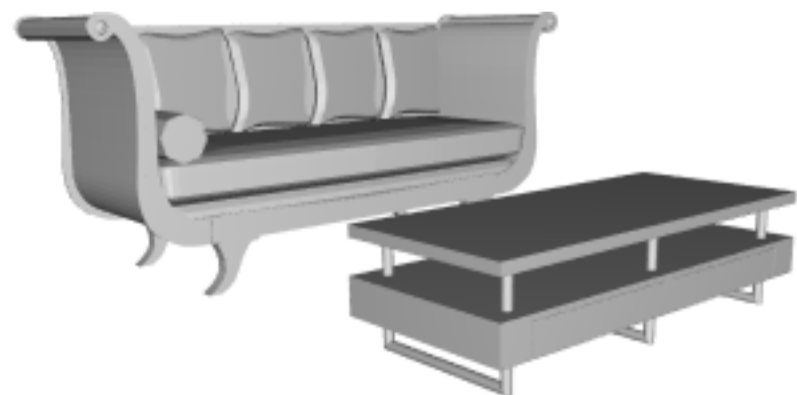

0.222222



0.222222

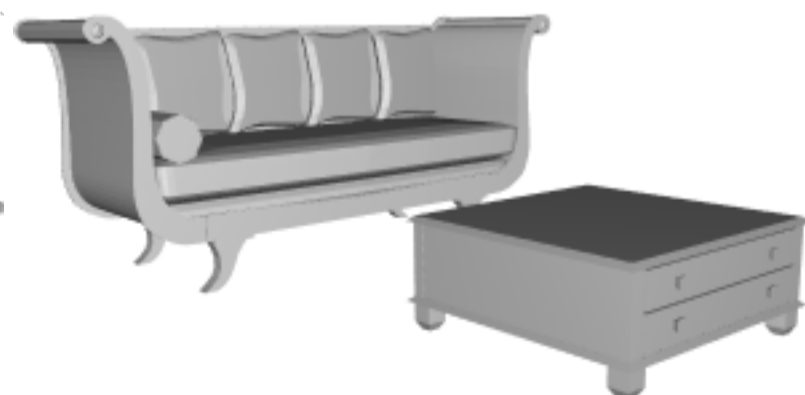

0

Task 3 of 50 Score = 0.00823045



0.818182

0.363636

0.272727



0.272727

0.181818

0.0909091

Task 4 of 50 Score = 0.00823045



0.818182

0.454545

0.272727

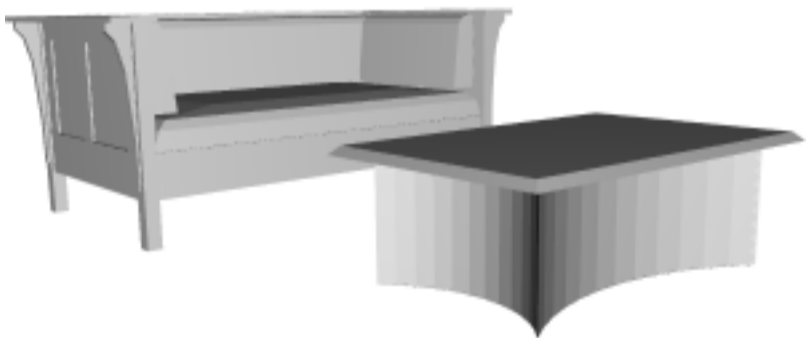

0.272727

0.181818

0

Task 5 of 50 Score = 0.0235157

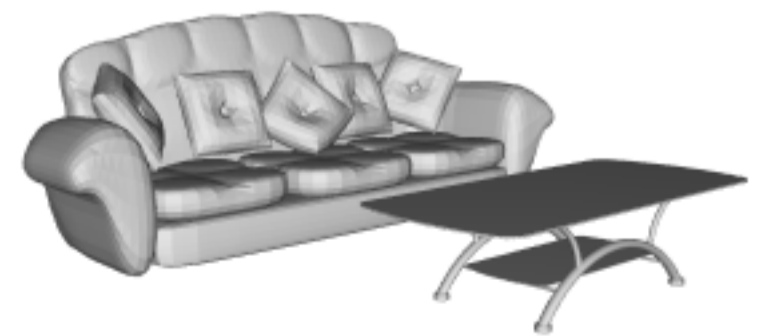

0.666667

0.5

0.277778





0.222222

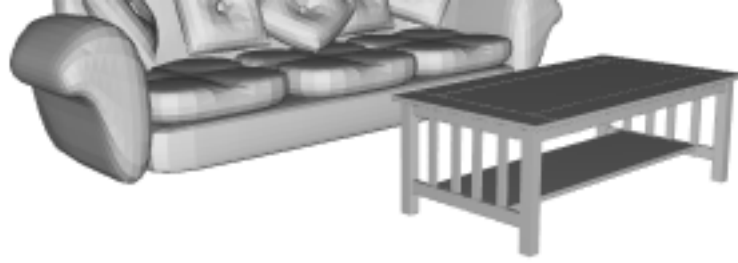

0.166667

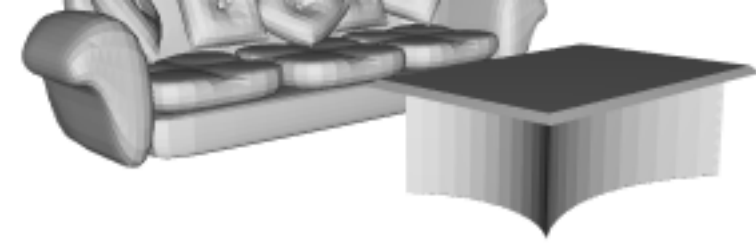

0.166667

Task 6 of 50 Score = 0.0235157



0.666667

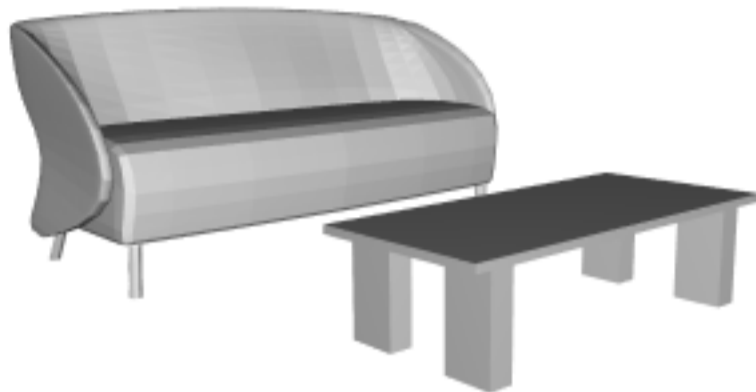

0.444444

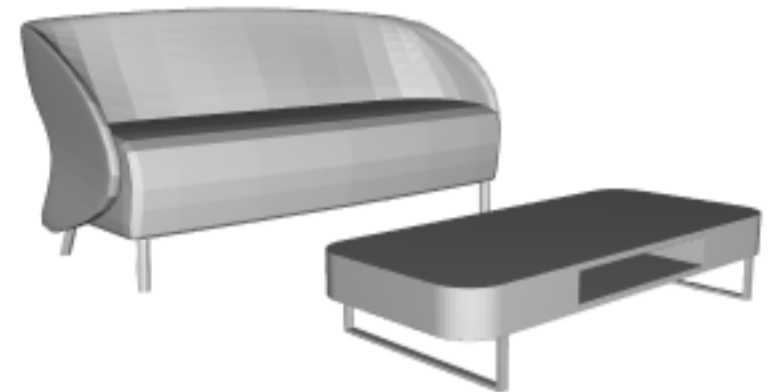

0.333333

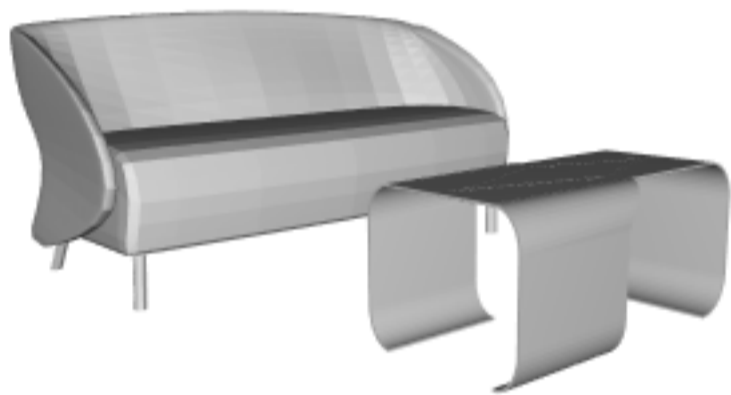

0.277778

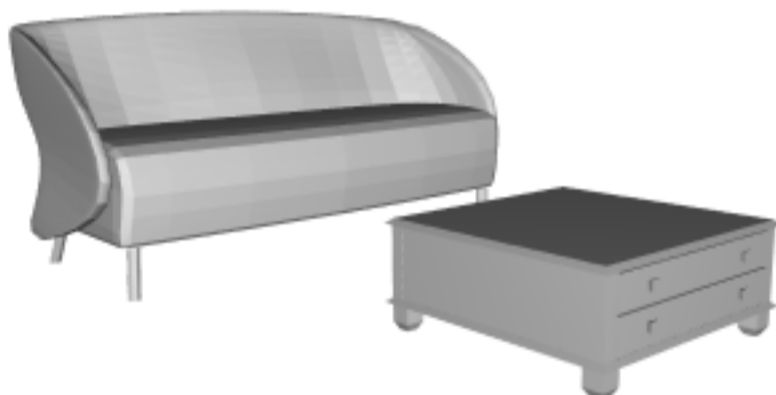

0.222222

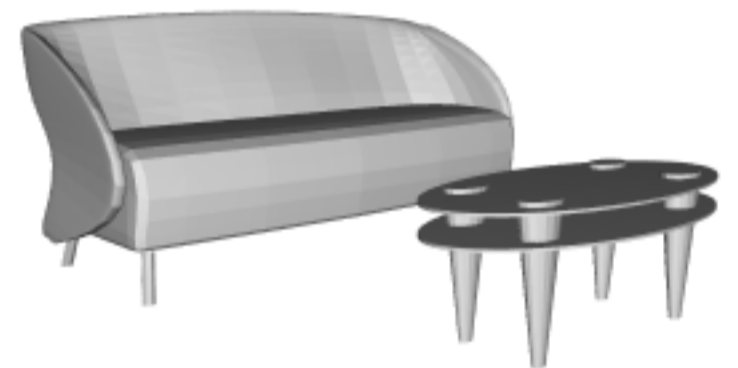

0.055556

Task 7 of 50 Score = 0.0235157



0.666667



0.5

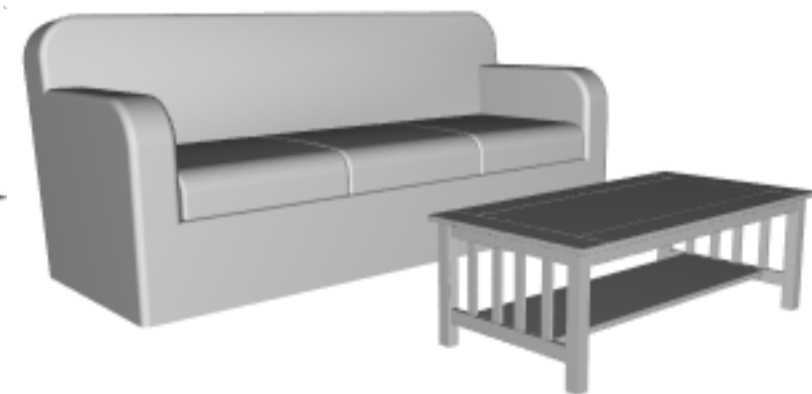

0.333333

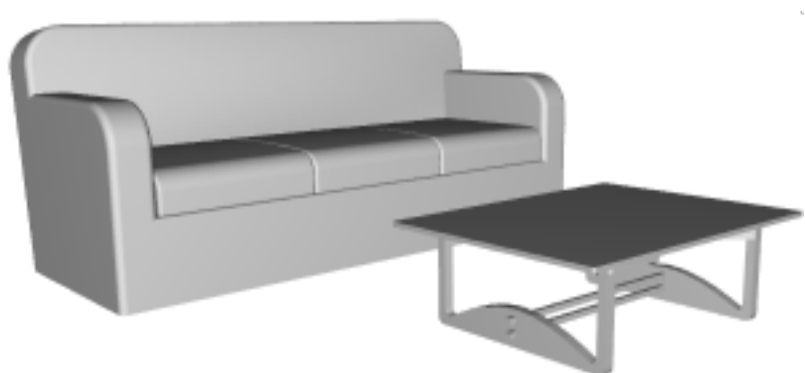

0.166667



0.166667

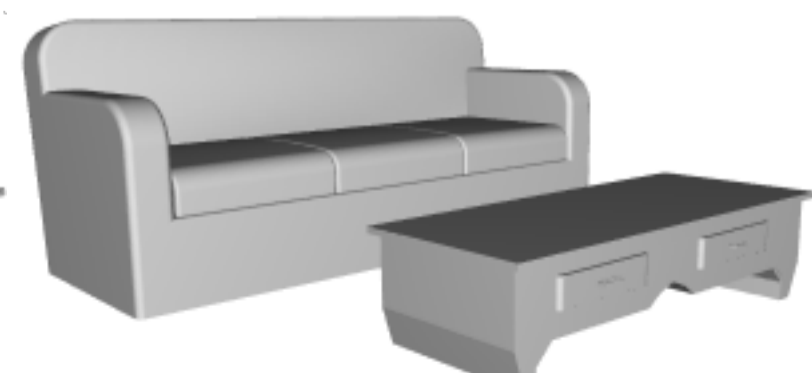

0.166667

Task 8 of 50 Score = 0.0529391



0.727273



0.545455

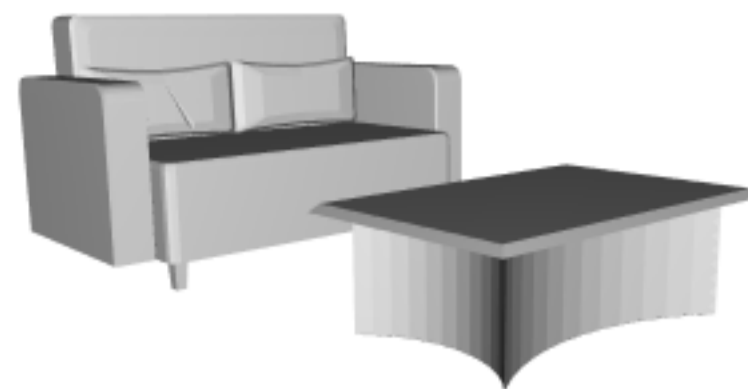

0.363636



0.272727



0.0909091



0

Task 9 of 50 Score = 0.0529391



0.727273

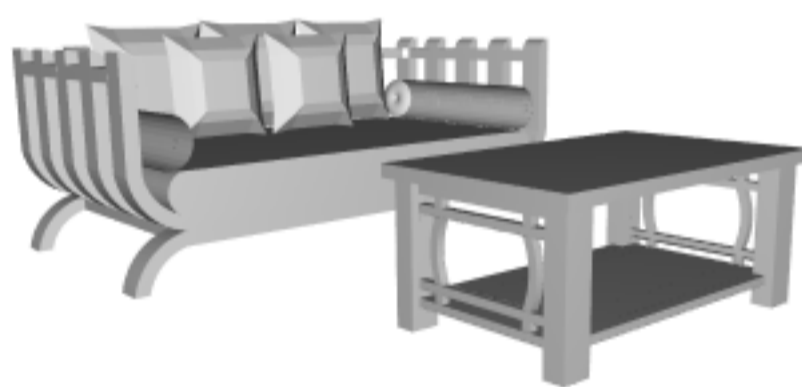

0.636364



0.272727

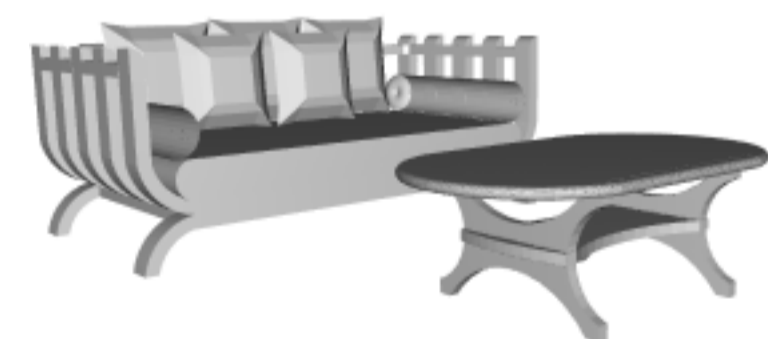

0.272727

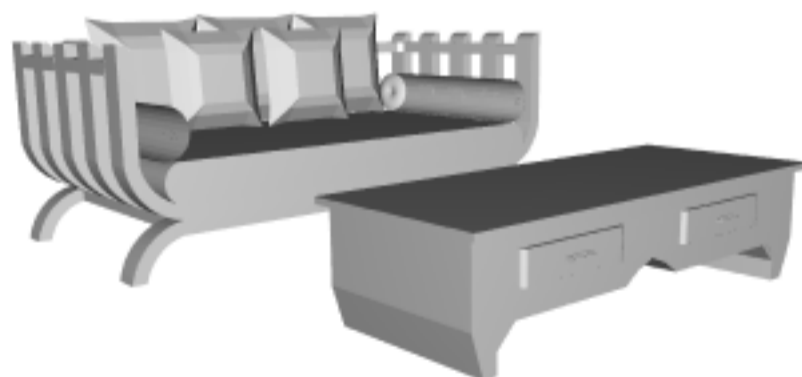

0.0909091

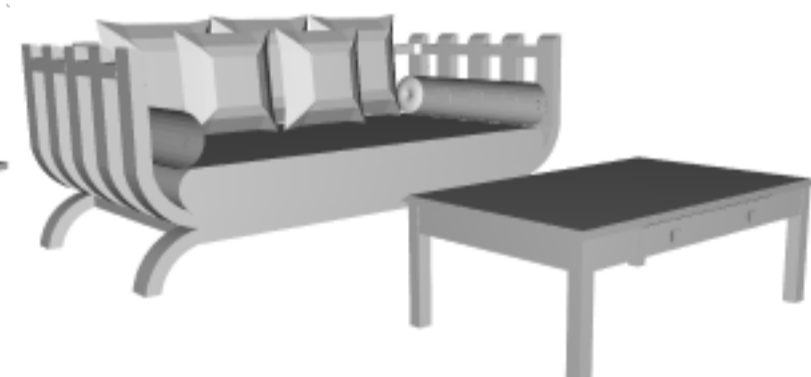

0

Task 10 of 50 Score = 0.0529391



0.727273



0.181818

0.636364

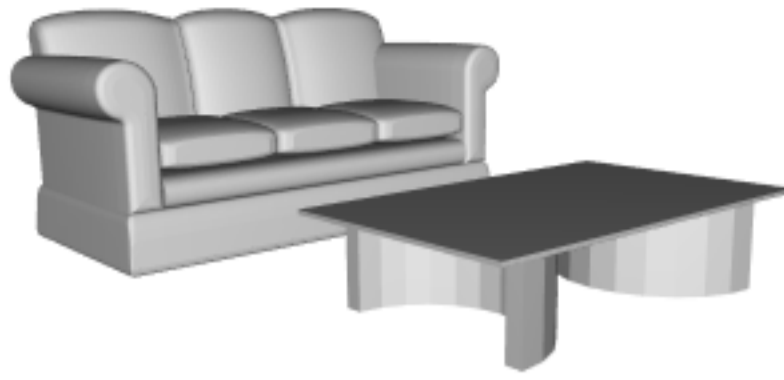

0.181818

0.272727



0

Task 11 of 50 Score = 0.0529391

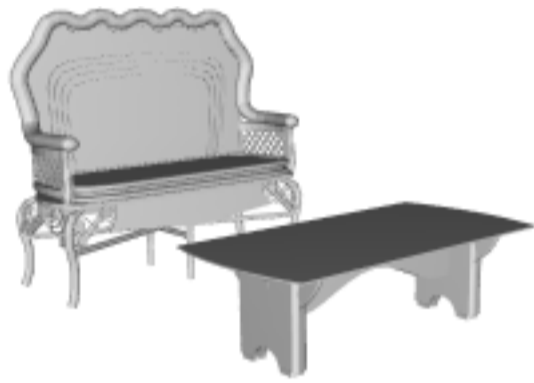

0.727273



0.454545

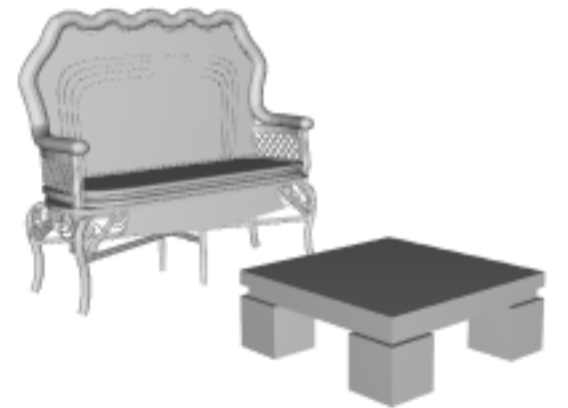

0.272727

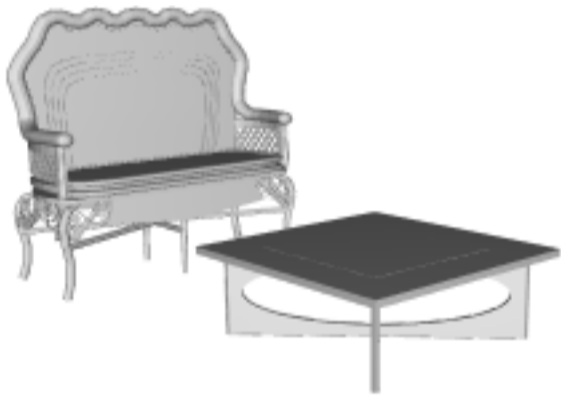

0.272727

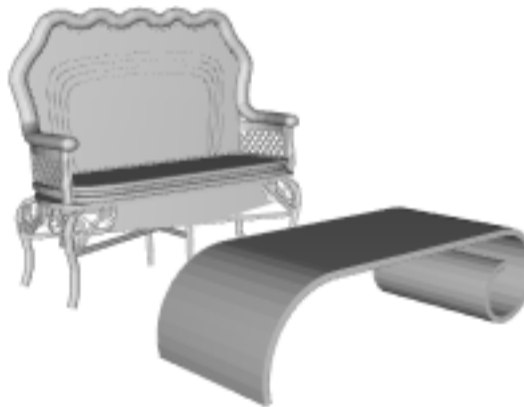

0.181818

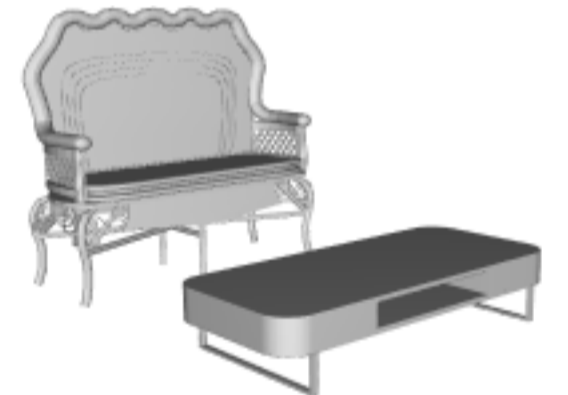

0.0909091

Task 12 of 50 Score = 0.0866017



0.611111



0.5



0.277778

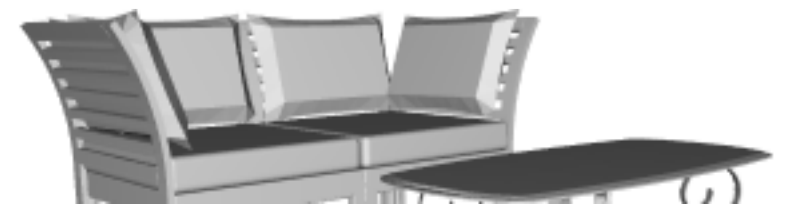



0.277778

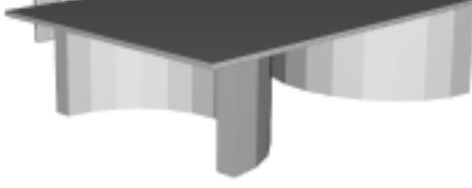

0.222222



0.111111

Task 13 of 50 Score = 0.231774



0.636364



0.545455



0.363636



0.272727



0.0909091



0.0909091

Task 14 of 50 Score = 0.231774



0.636364

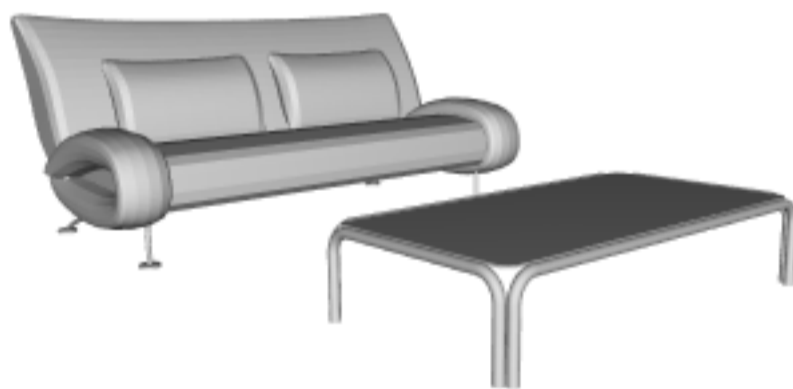

0.454545

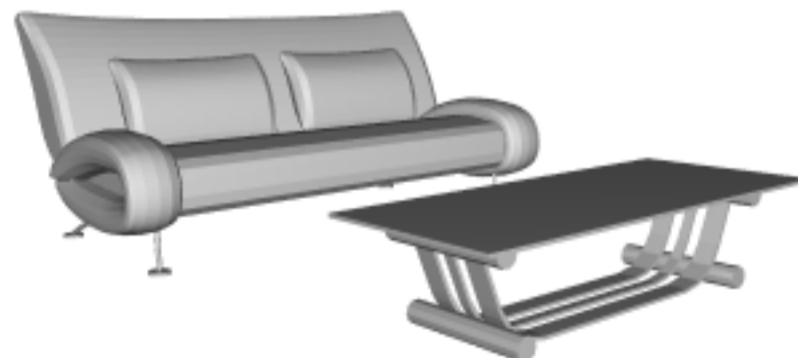

0.454545



0.363636

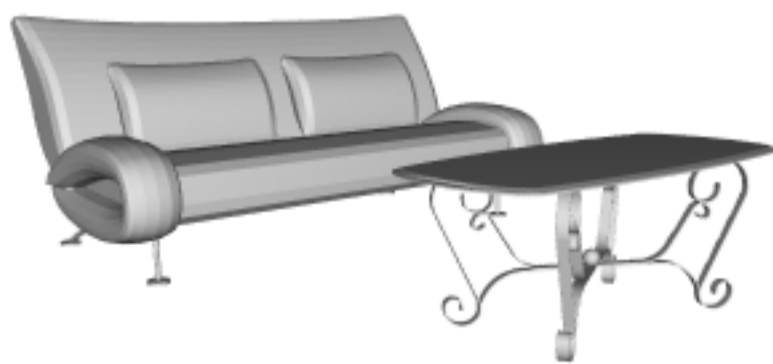

0.0909091

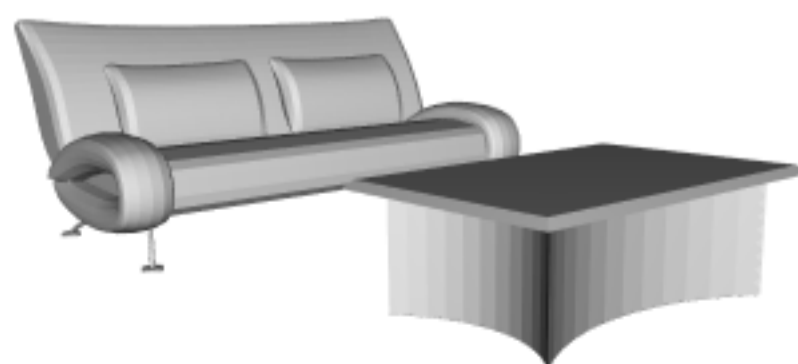

0

Task 15 of 50 Score = 0.231774



0.636364



0.545455



0.363636



0.272727



0.0909091

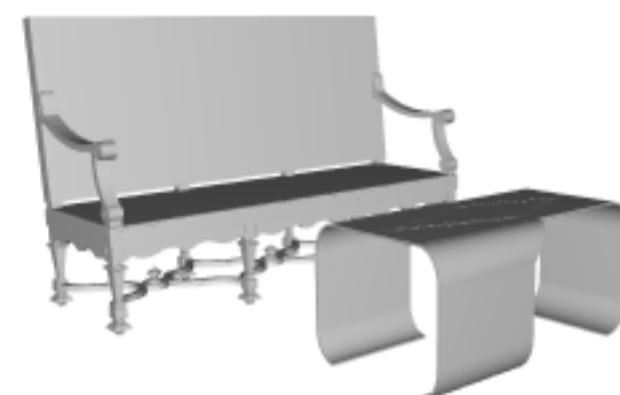

0.0909091

Task 16 of 50 Score = 0.231774



0.636364



0.545455



0.363636



0.272727



0.0909091



0.0909091

Task 17 of 50 Score = 0.231774

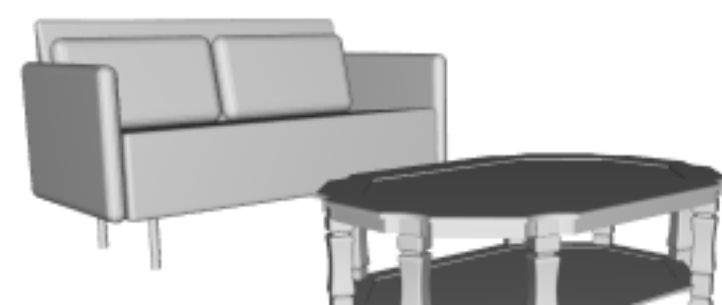
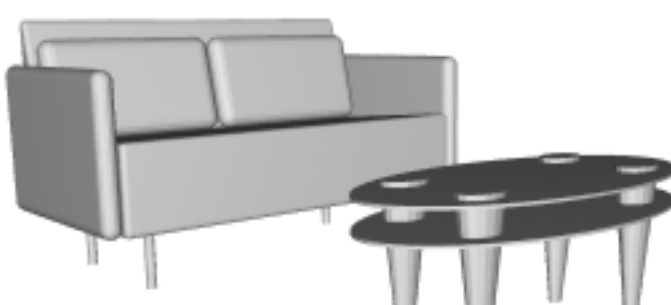

0.636364



0.272727

0.545455

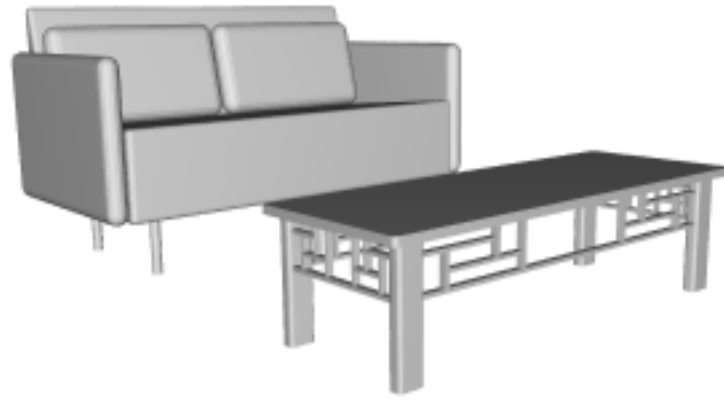

0.181818

0.272727

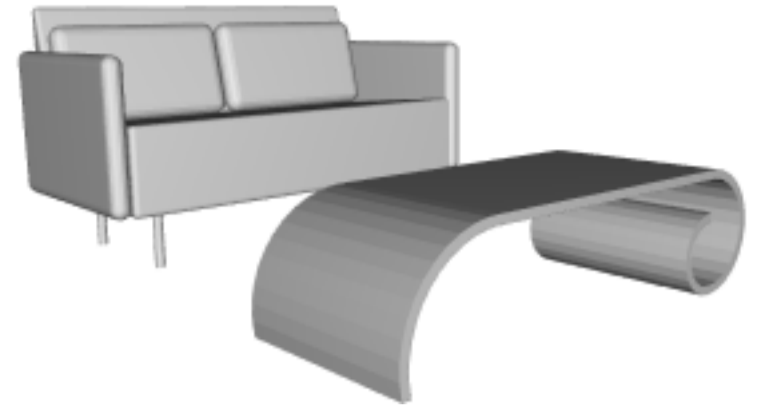

0.0909091

Task 18 of 50 Score = 0.260088

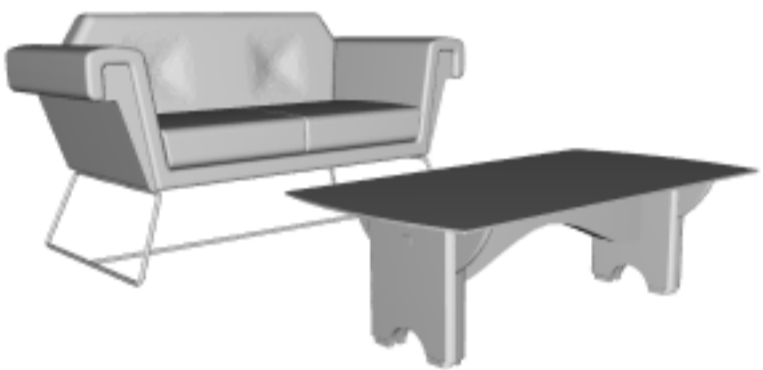

0.555556



0.444444



0.388889



0.277778

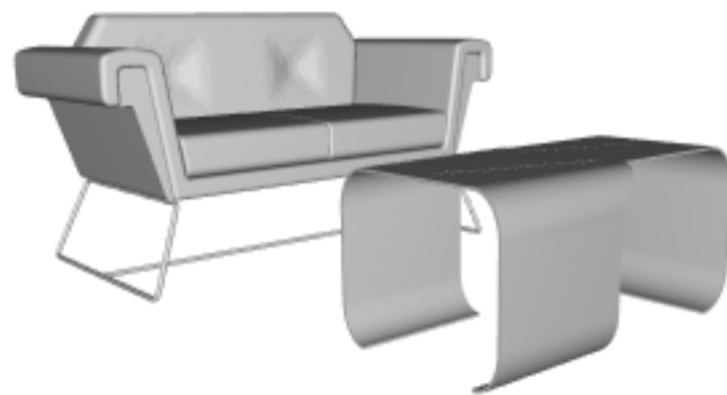

0.222222

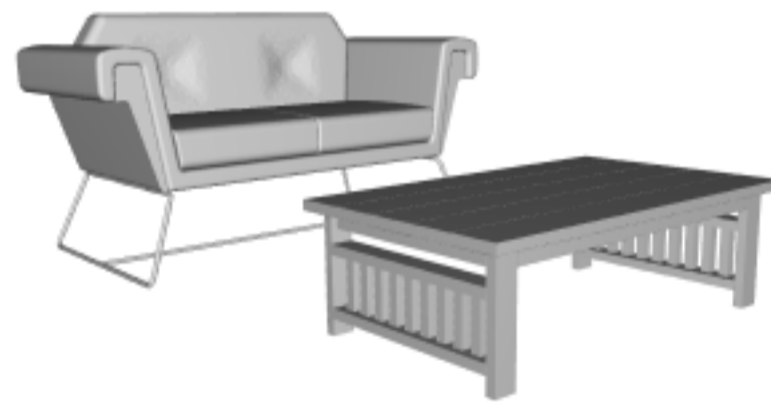

0.111111

Task 19 of 50 Score = 0.260088

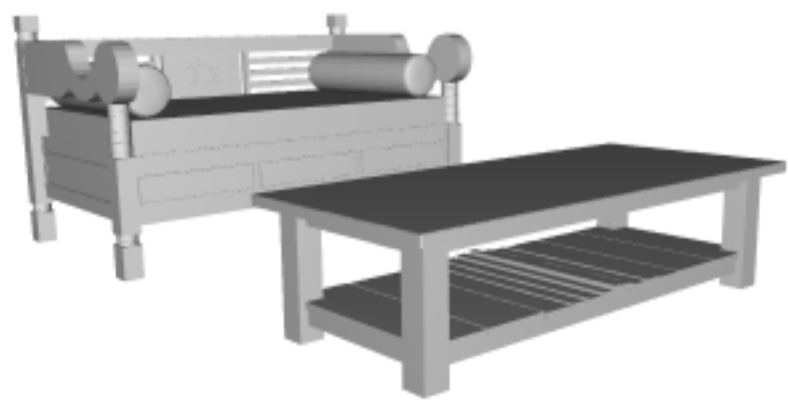

0.555556

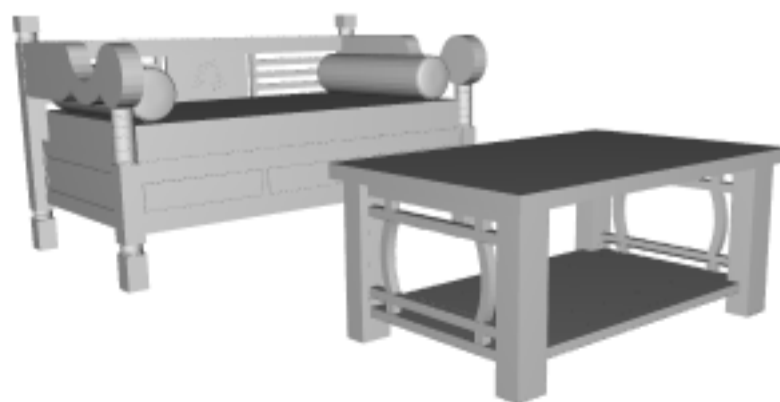

0.5

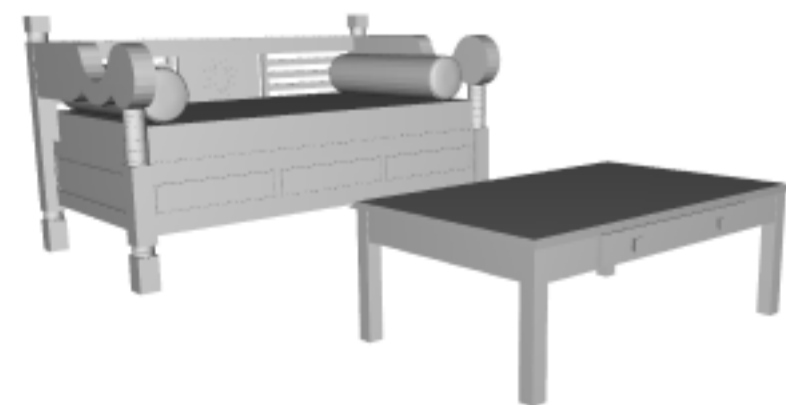

0.333333

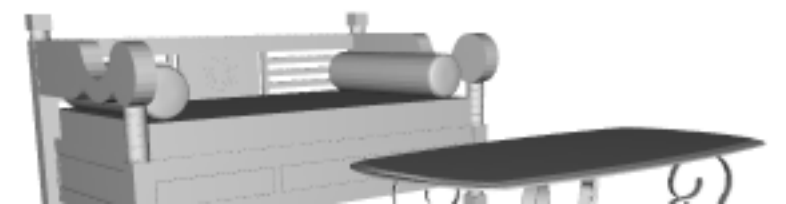
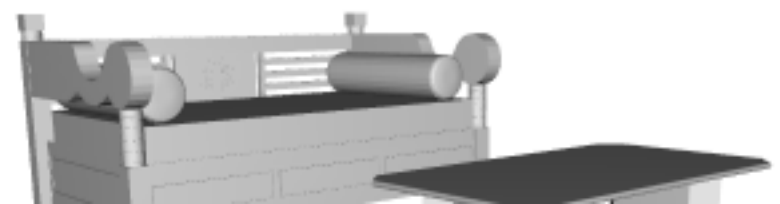
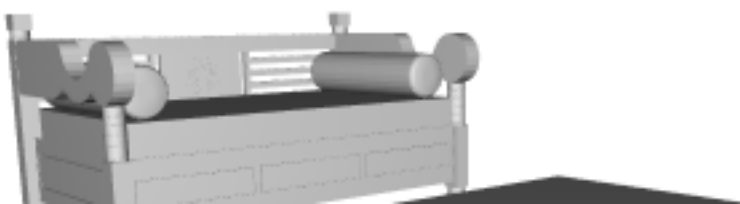

0.277778

0.166667

0.166667

Task 20 of 50 Score = 0.260088

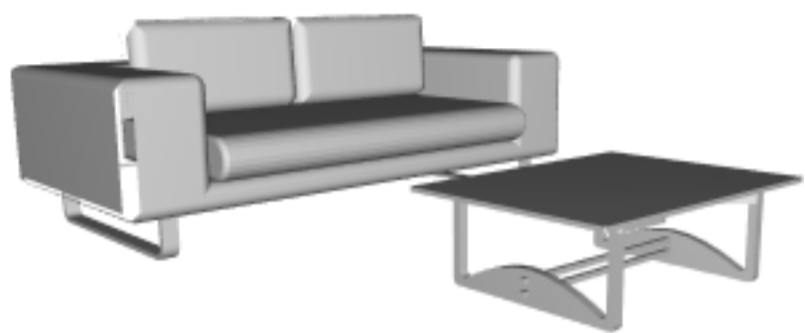

0.555556

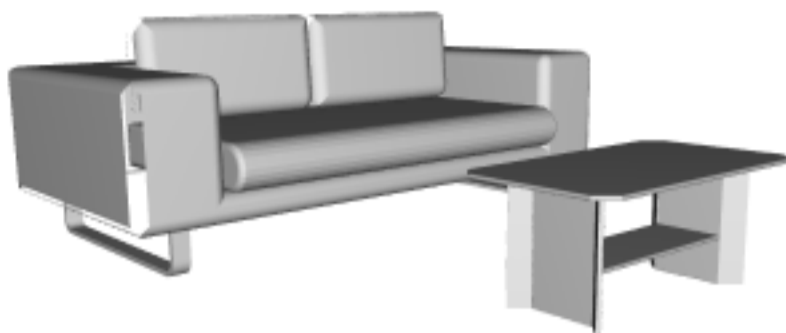

0.555556

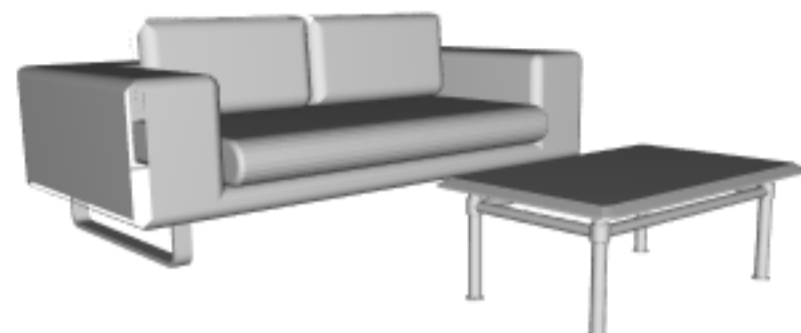

0.388889

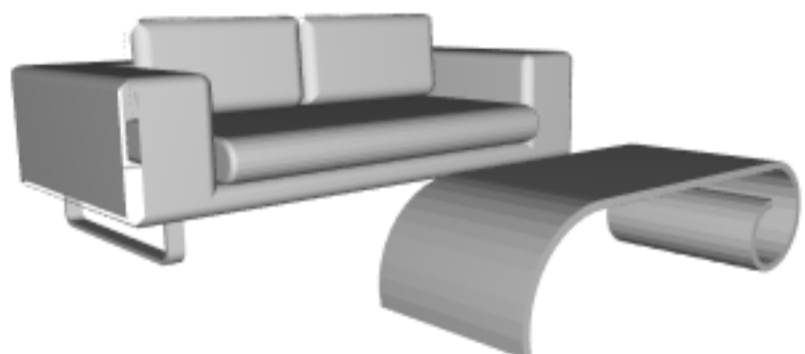

0.277778

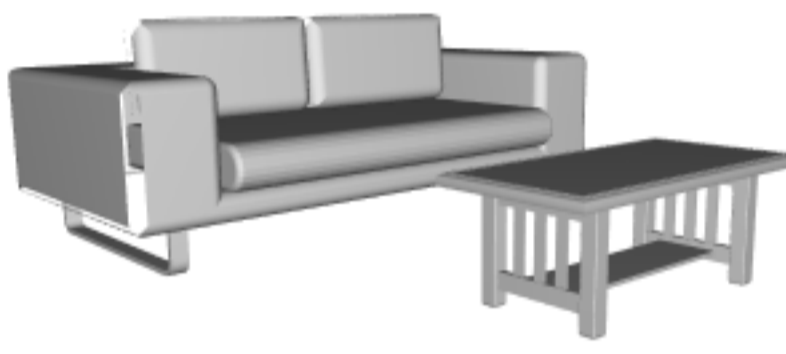

0.166667

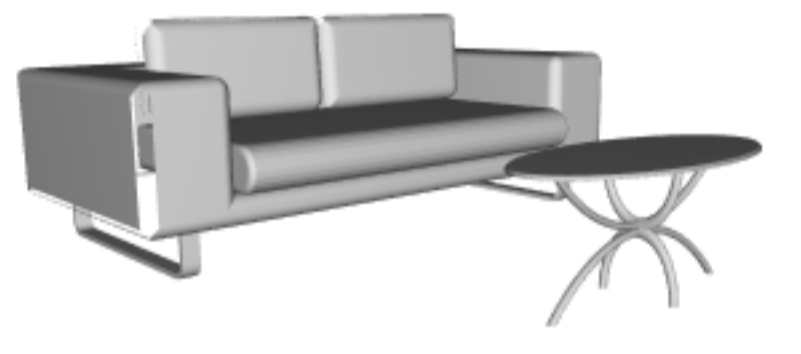

0.055556

Task 21 of 50 Score = 0.260088



0.555556



0.333333

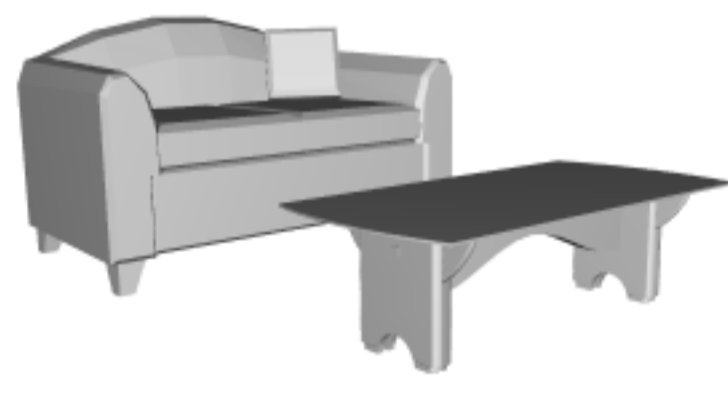

0.333333



0.333333



0.277778

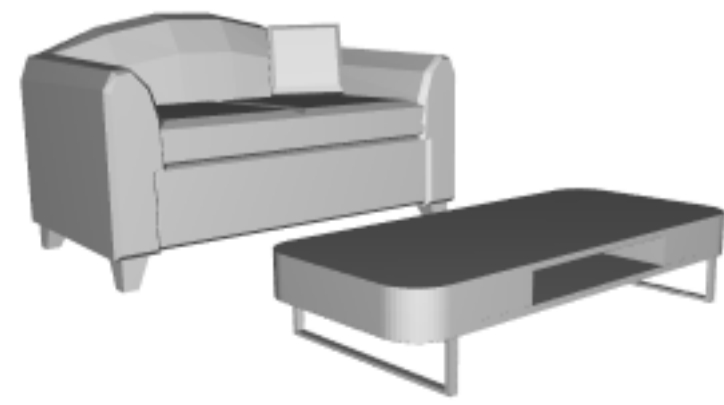

0.166667

Task 22 of 50 Score = 0.260088



0.555556



0.388889



0.277778



0.277778

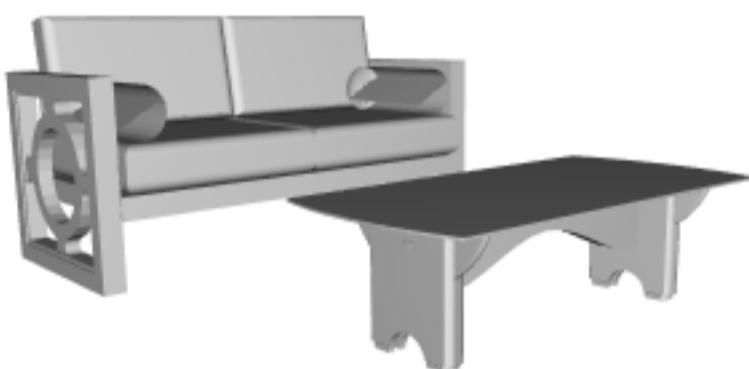

0.277778



0.222222

Task 23 of 50 Score = 0.260088

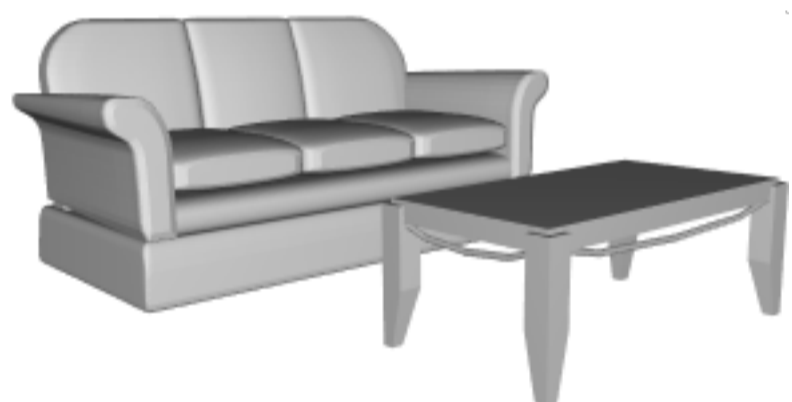

0.555556



0.444444

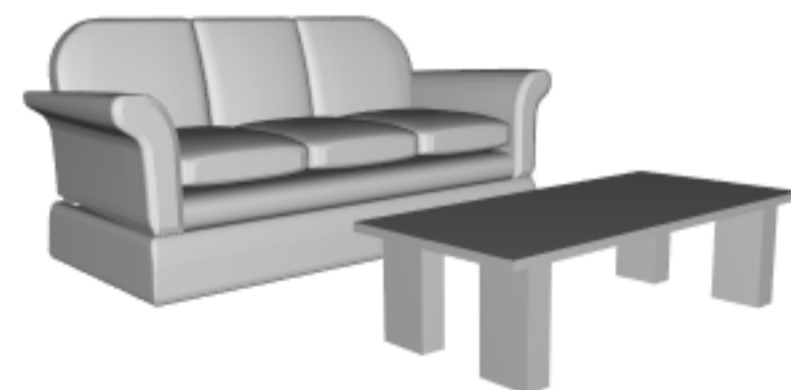

0.444444



0.222222



0.222222

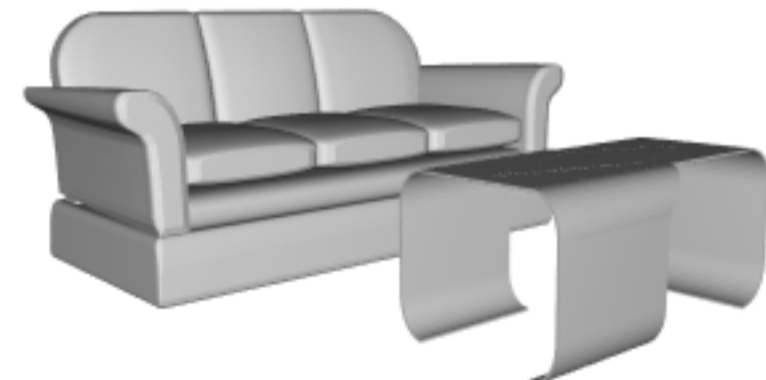

0.111111

Task 24 of 50 Score = 0.260088

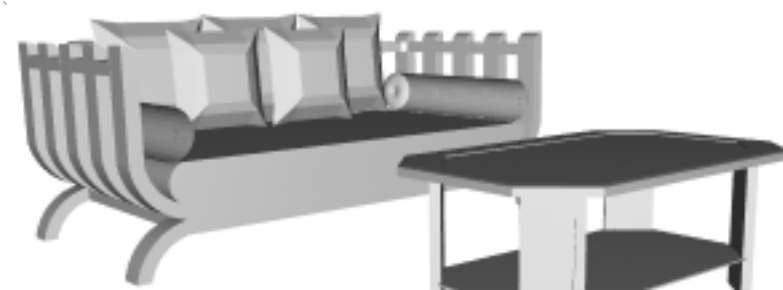
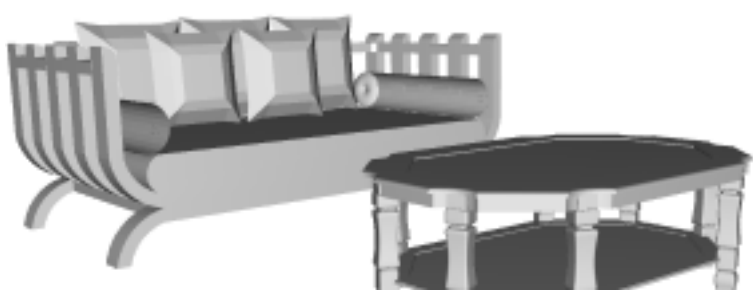
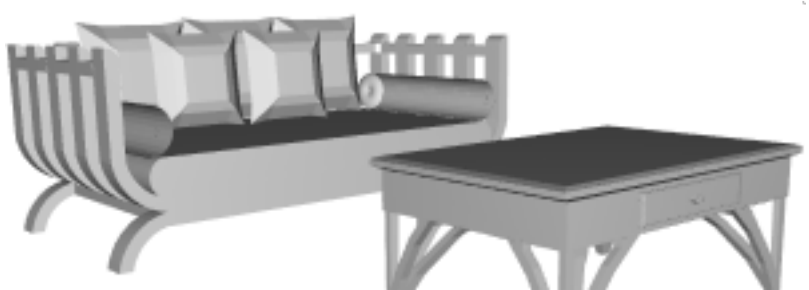

0.555556

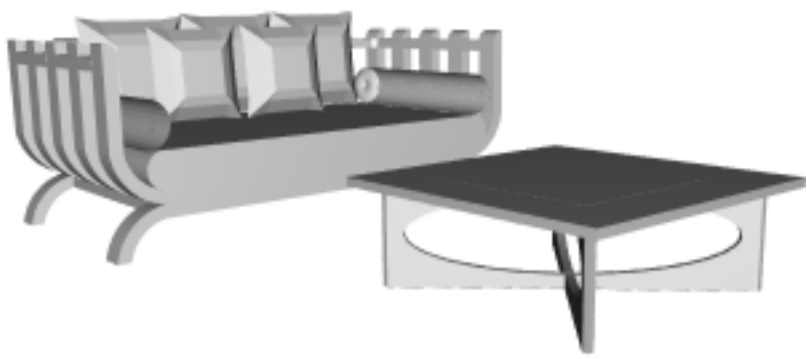

0.388889

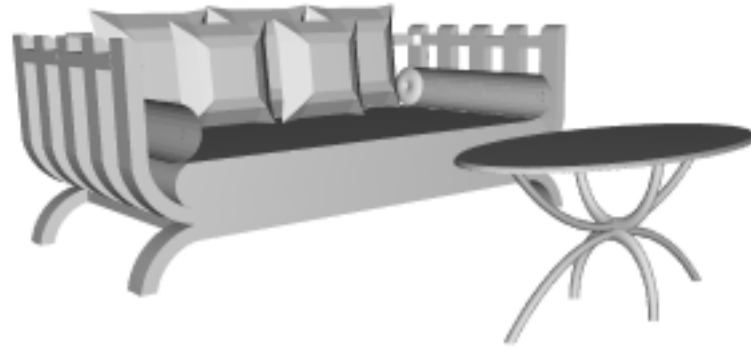

0.333333

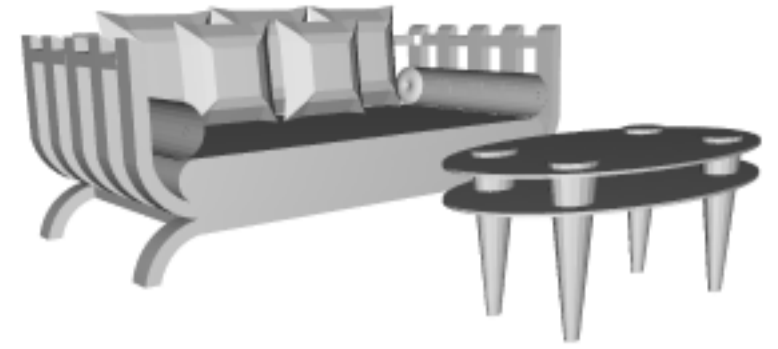

0.277778



0.277778



0.166667



Task 25 of 50 Score = 0.260088



0.555556

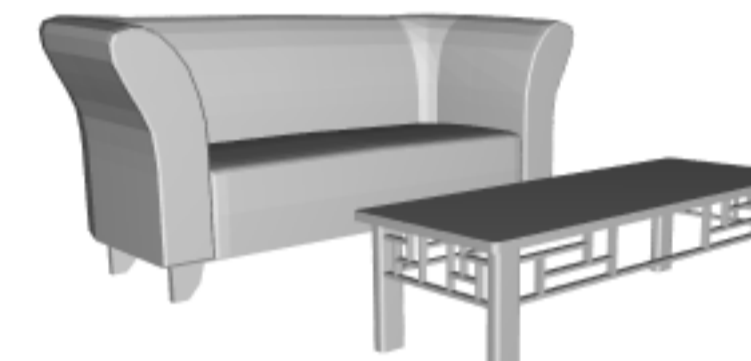

0.444444



0.388889



0.277778



0.166667

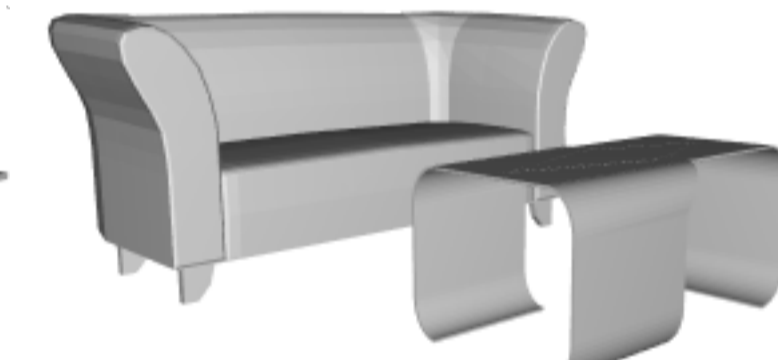

0.166667

Task 26 of 50 Score = 0.260088



0.555556



0.5



0.444444

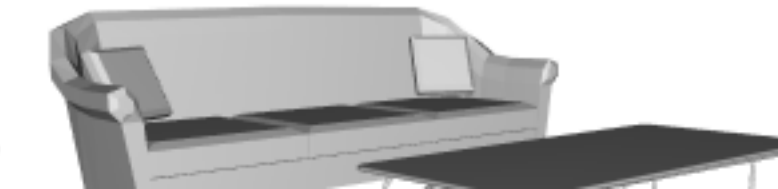
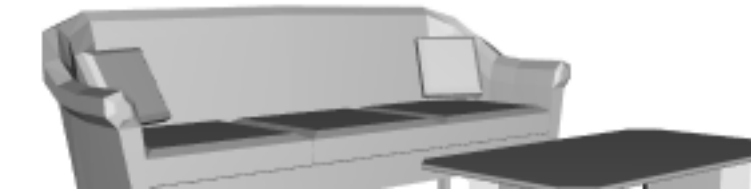
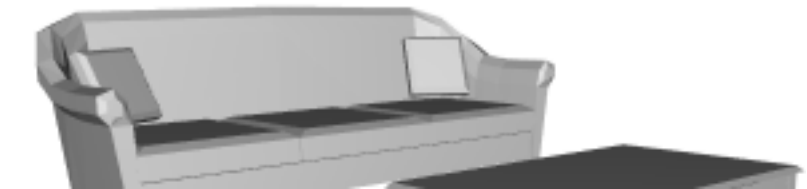



0.277778



0.222222



0

Task 27 of 50 Score = 0.645614



0.5

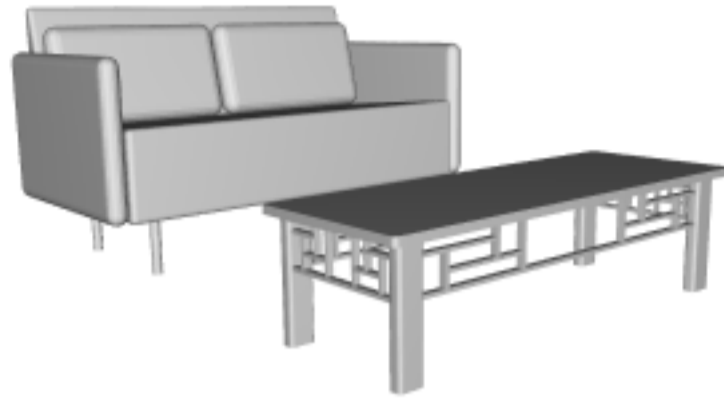

0.388889

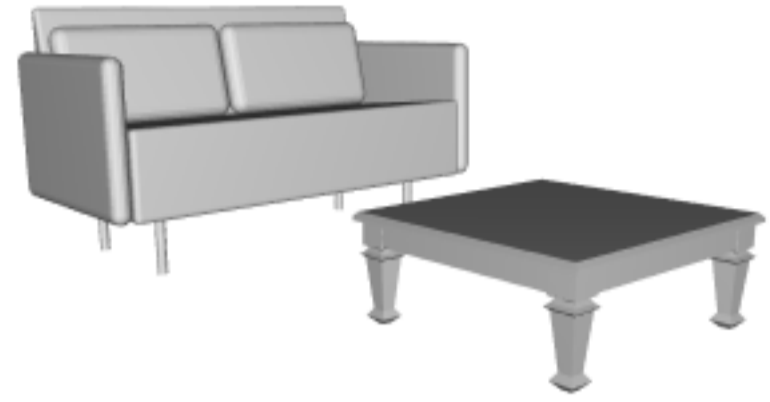

0.388889



0.388889

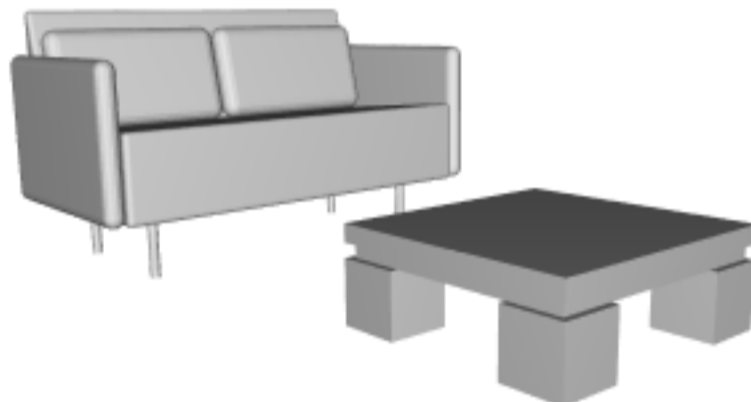

0.277778

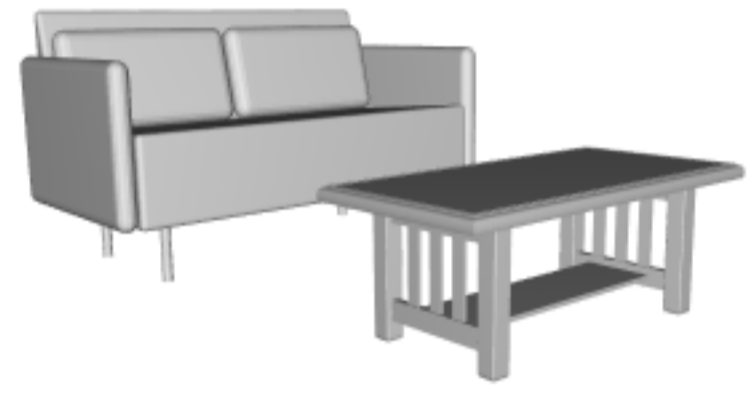

0.0555556

Task 28 of 50 Score = 0.645614



0.5



0.333333



0.333333

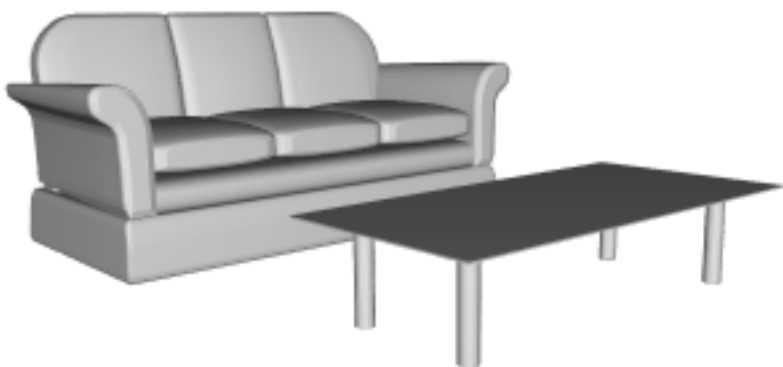

0.333333



0.277778



0.222222

Task 29 of 50 Score = 0.645614

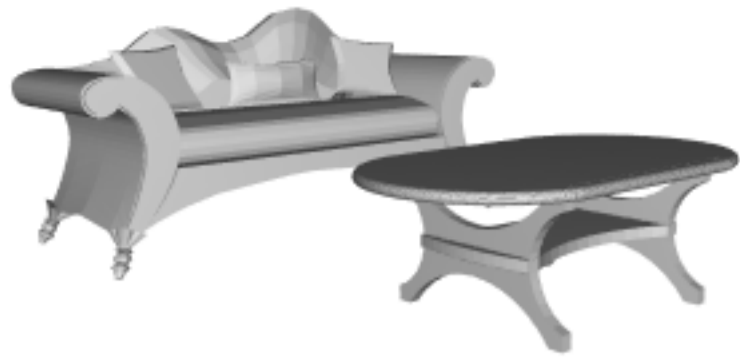

0.5

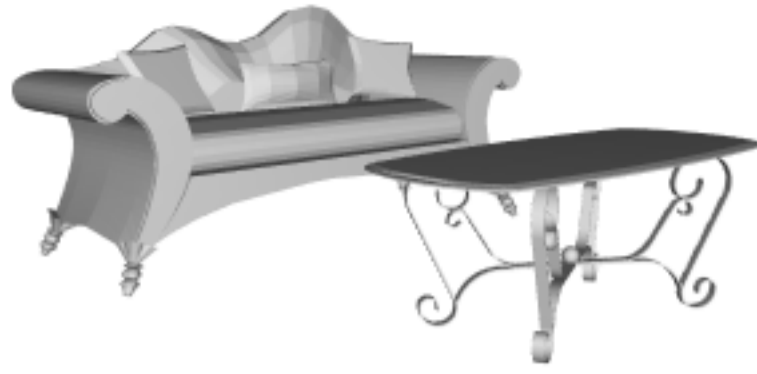

0.444444

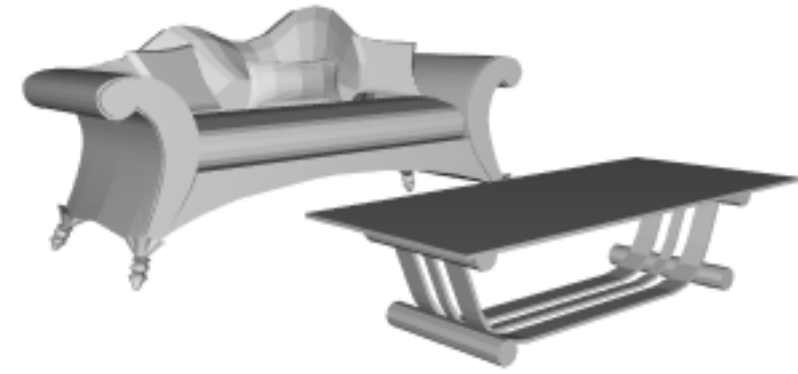

0.333333

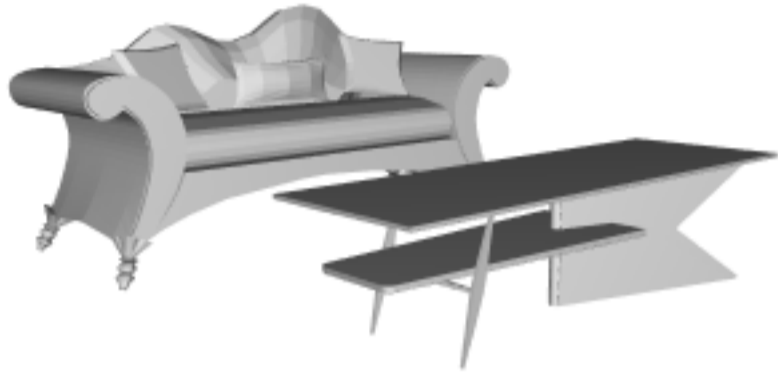

0.277778

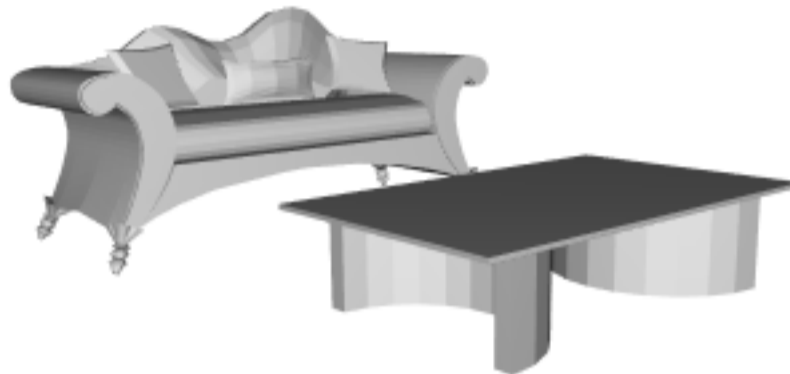

0.277778

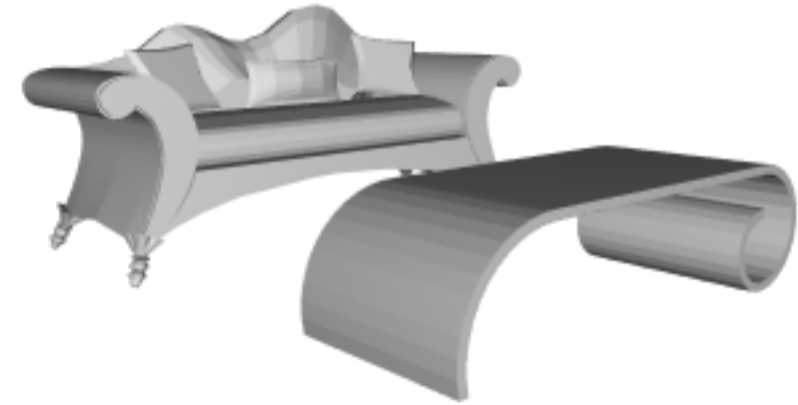

0.166667

Task 30 of 50 Score = 0.645614

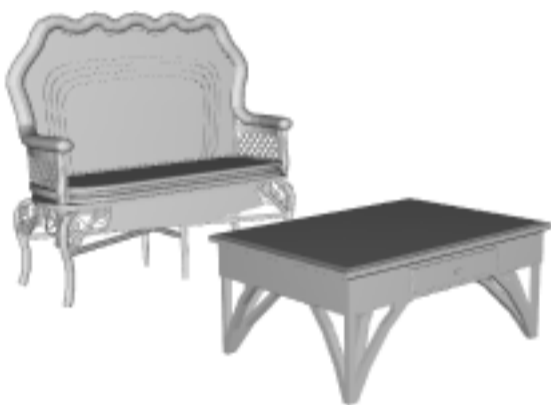

0.5



0.388889

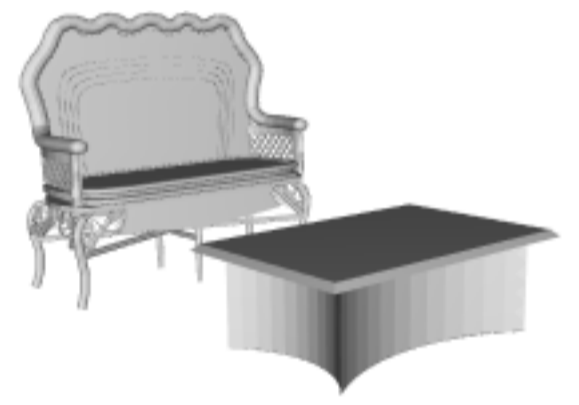

0.388889

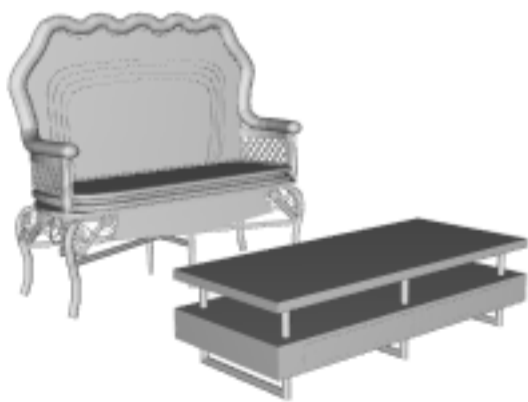

0.277778

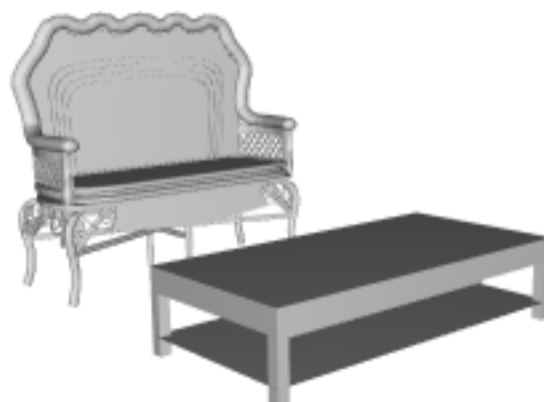

0.277778

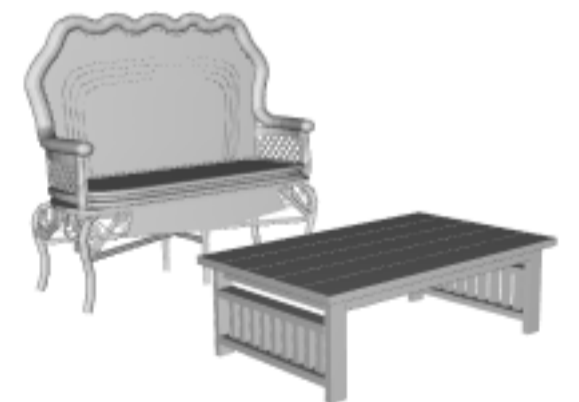

0.166667

Task 31 of 50 Score = 0.645614

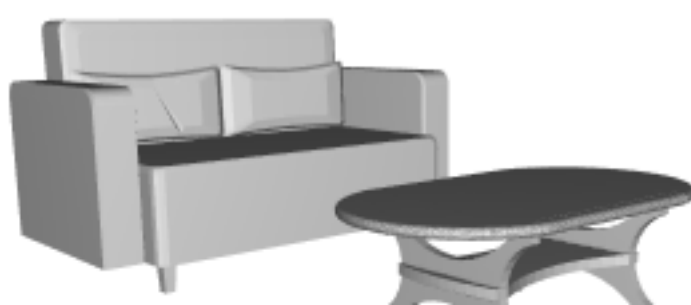
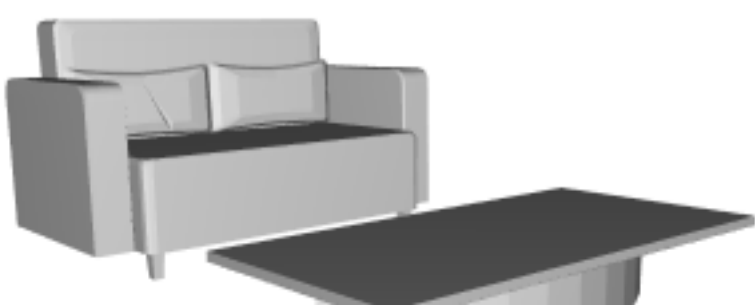

0.5



0.333333

0.444444



0.333333

0.388889

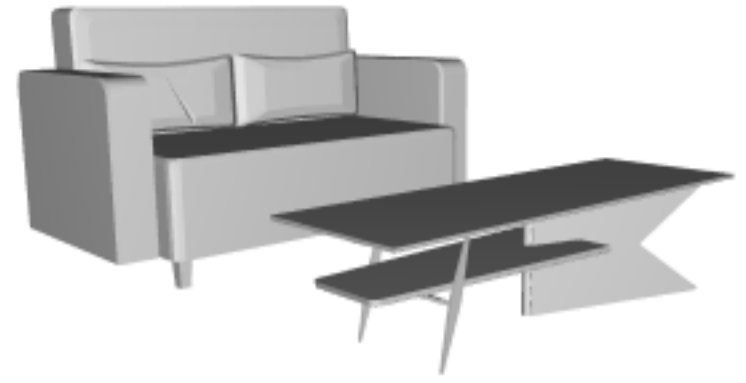

0

Task 32 of 50 Score = 0.645614

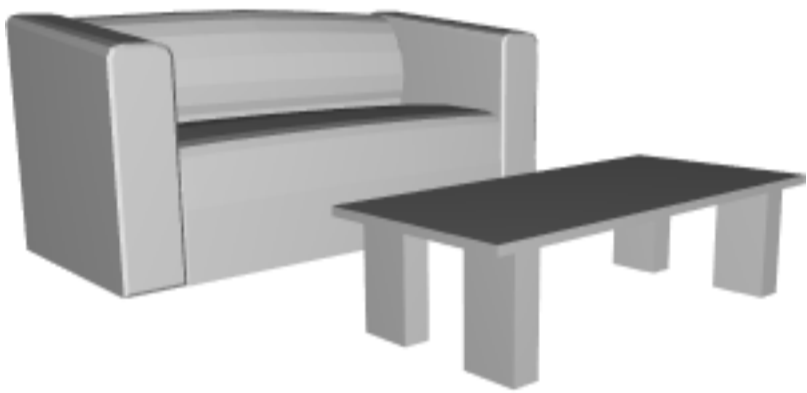

0.5



0.5

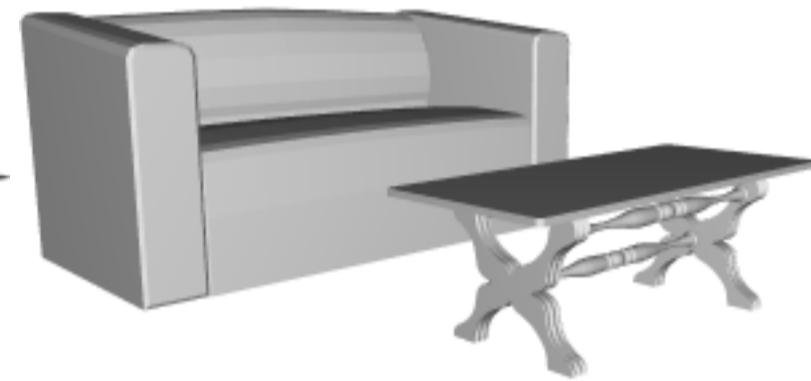

0.388889

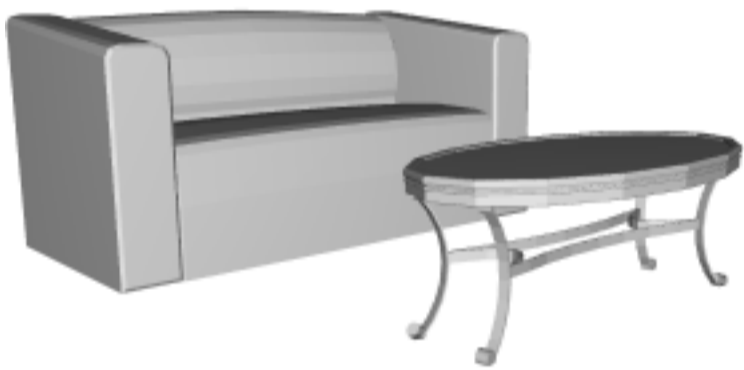

0.277778

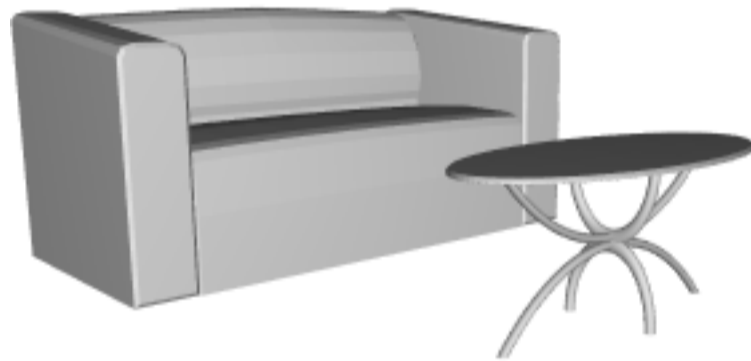

0.166667

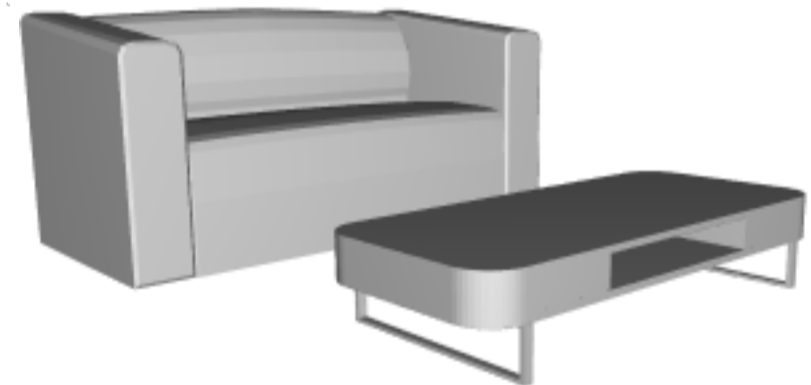

0.166667

Task 33 of 50 Score = 0.645614



0.5

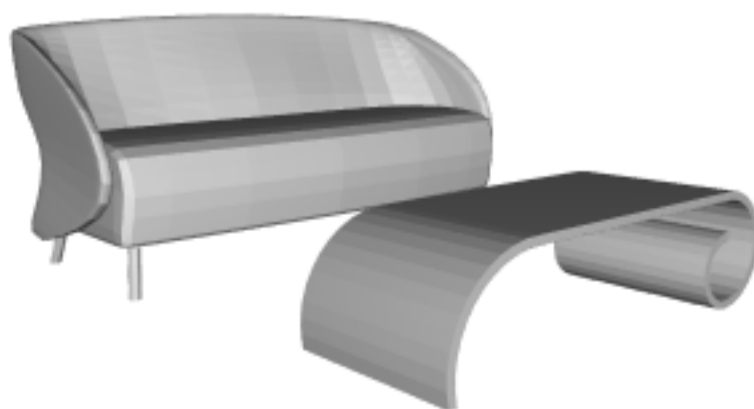

0.444444



0.388889

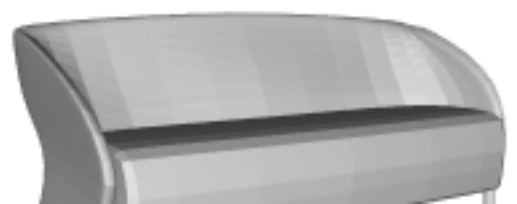
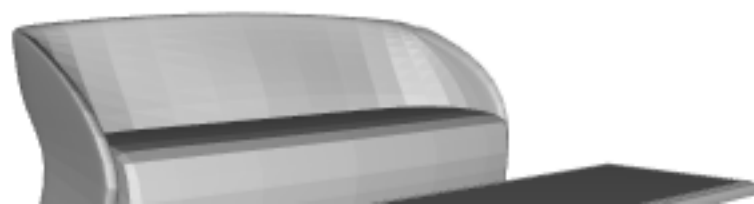
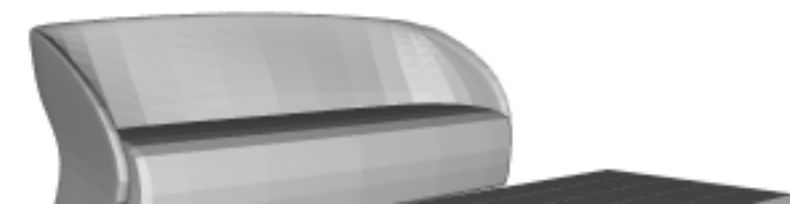

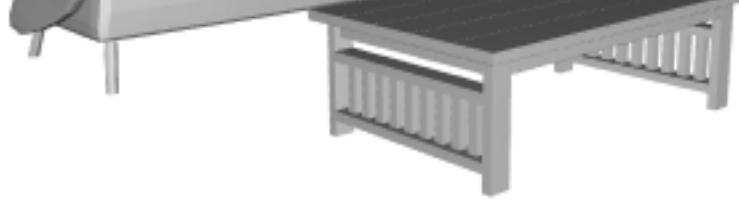

0.333333

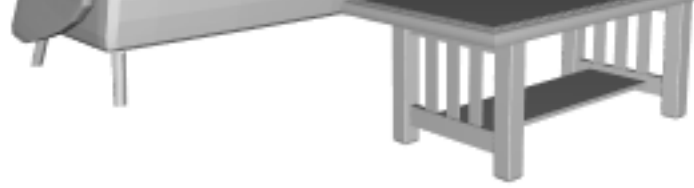

0.277778



0.055556

Task 34 of 50 Score = 0.645614

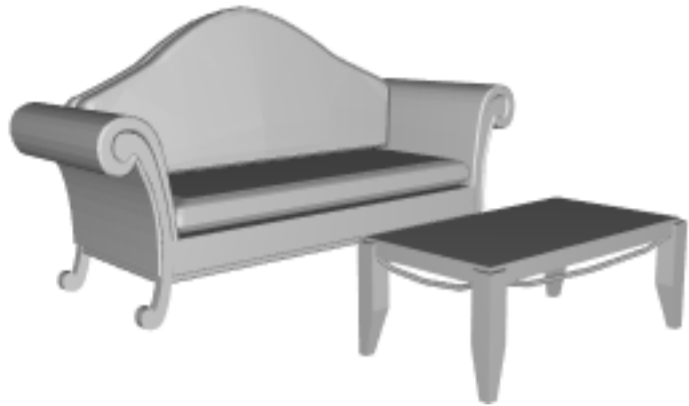

0.5

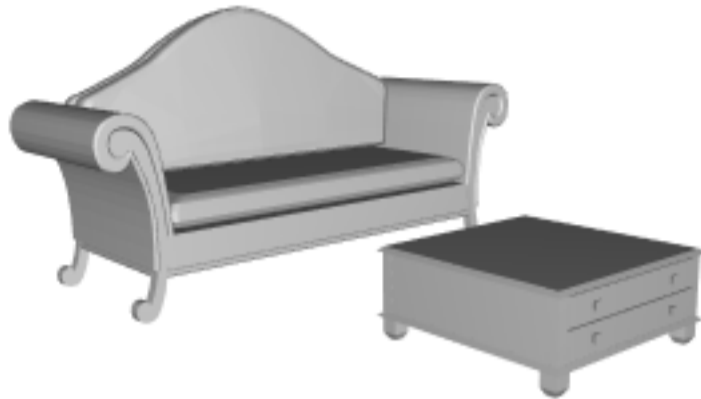

0.5

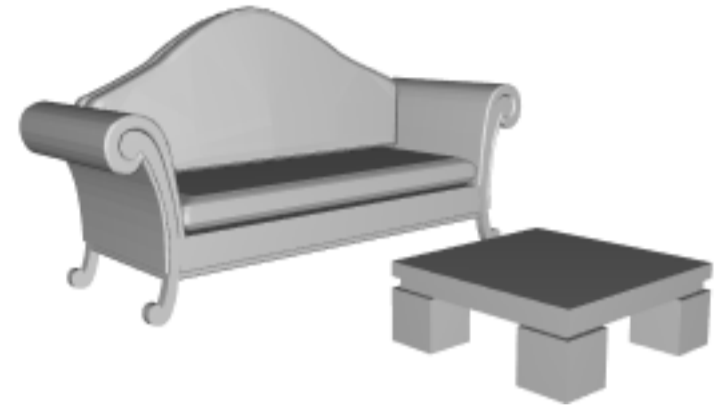

0.333333

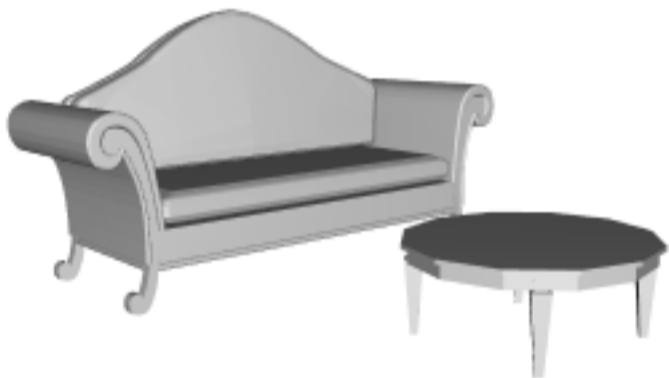

0.277778

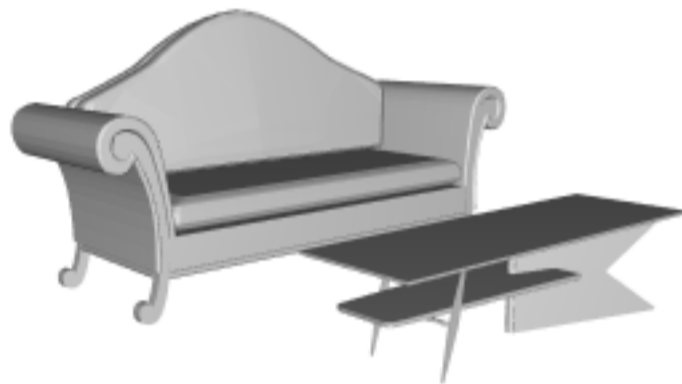

0.222222

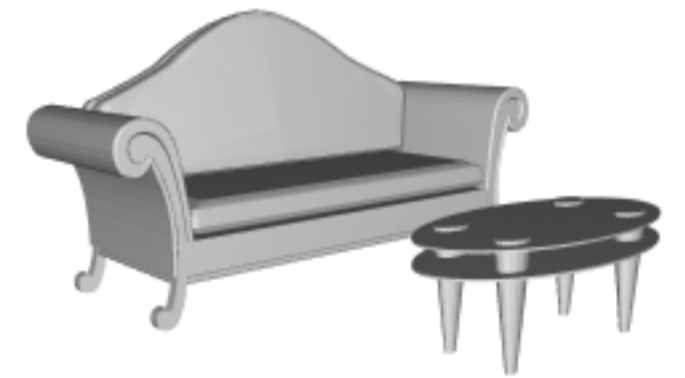

0.166667

Task 35 of 50 Score = 0.73251



0.545455



0.454545



0.363636

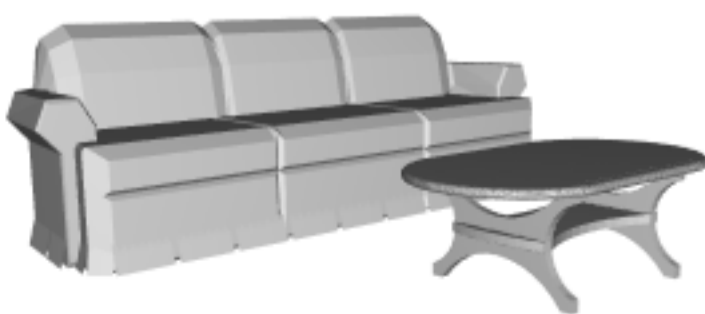

0.363636



0.181818

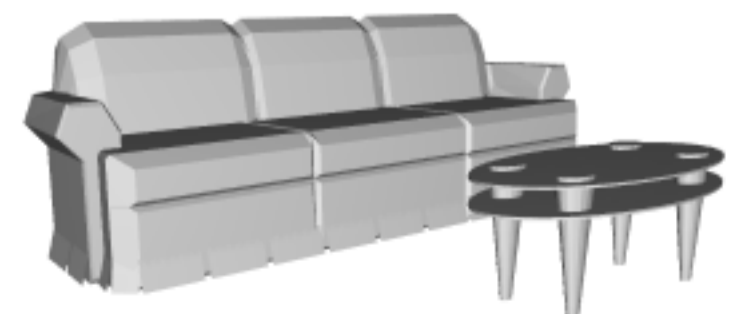

0.0909091

Task 36 of 50 Score = 0.73251

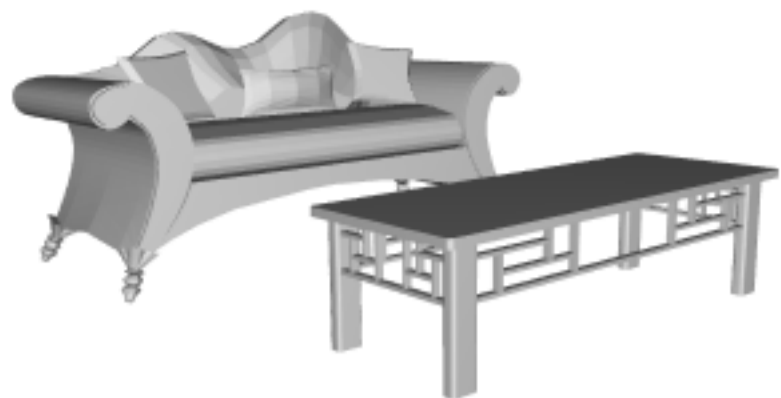

0.545455



0.454545

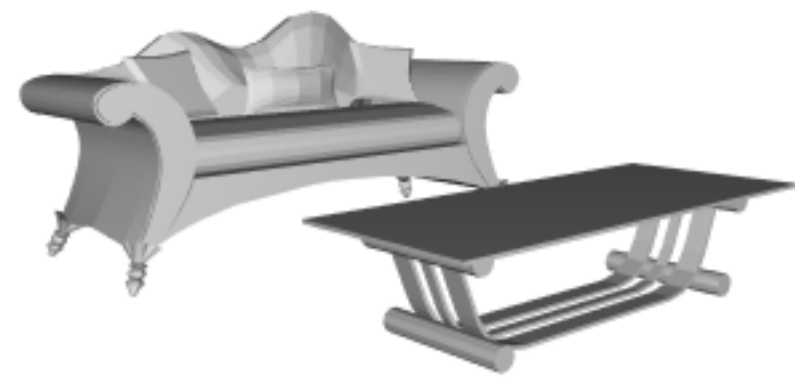

0.272727



0.272727

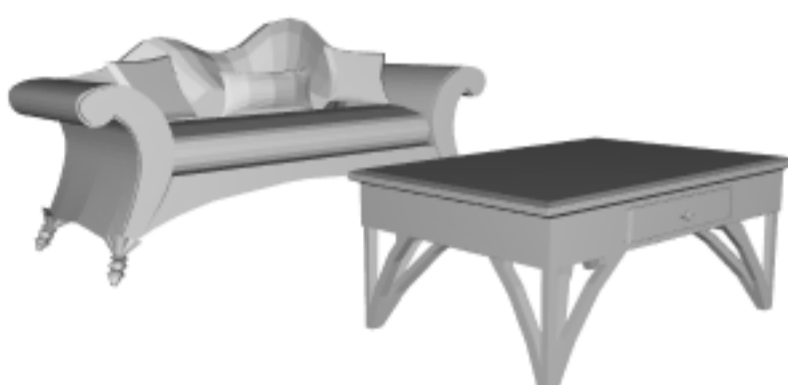

0.272727

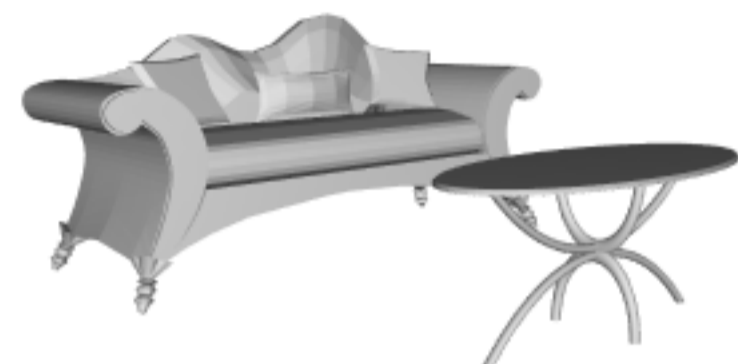

0.181818

Task 37 of 50 Score = 0.73251



0.545455

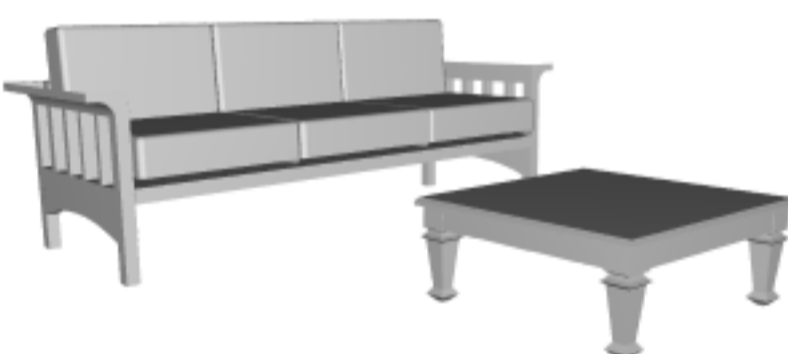

0.545455



0.454545



0.272727



0.181818

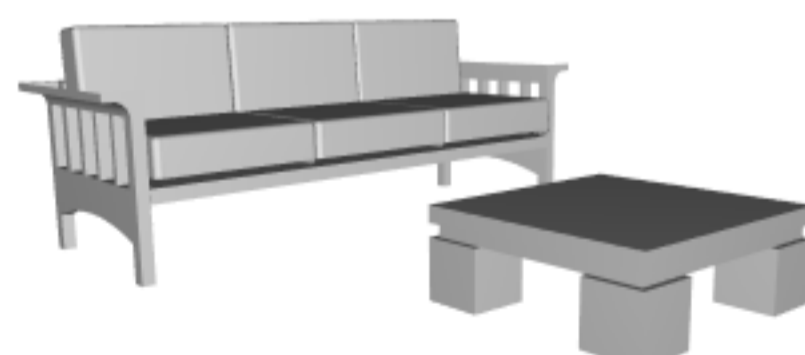

0

Task 38 of 50 Score = 0.73251



0.545455

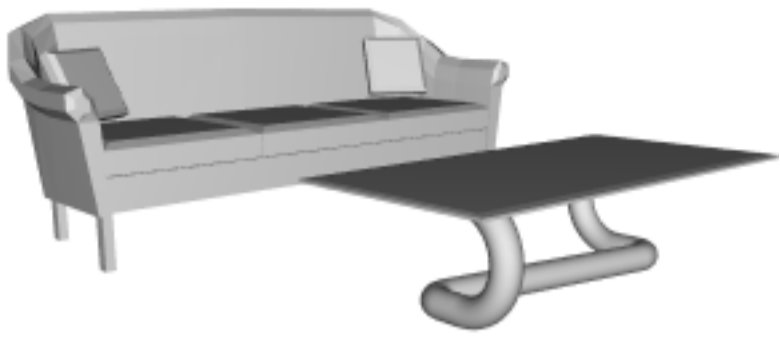

0.545455

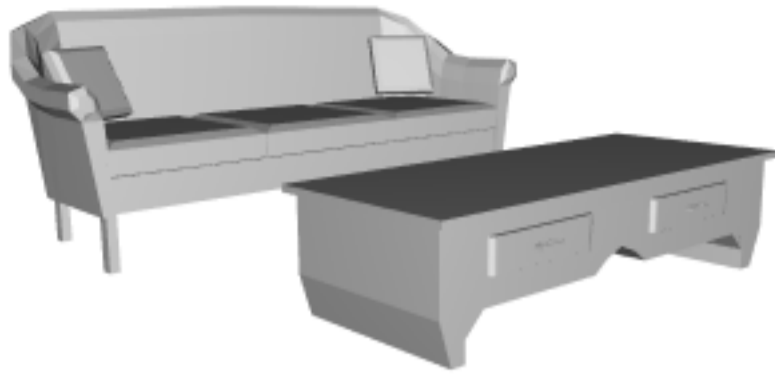

0.363636

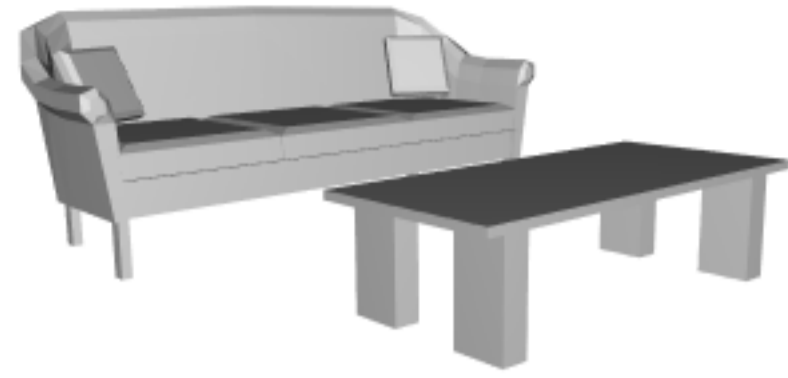

0.272727

0.181818

0.0909091

Task 39 of 50 Score = 0.73251

0.545455



0.545455



0.454545

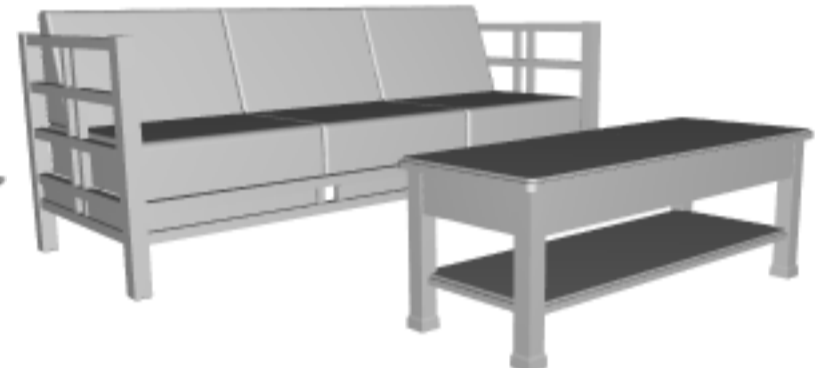

0.272727

0.0909091

0.0909091

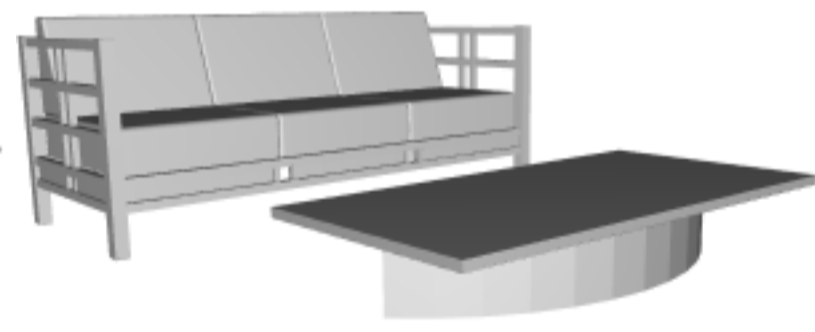

Task 40 of 50 Score = 0.73251

0.545455



0.454545



0.363636

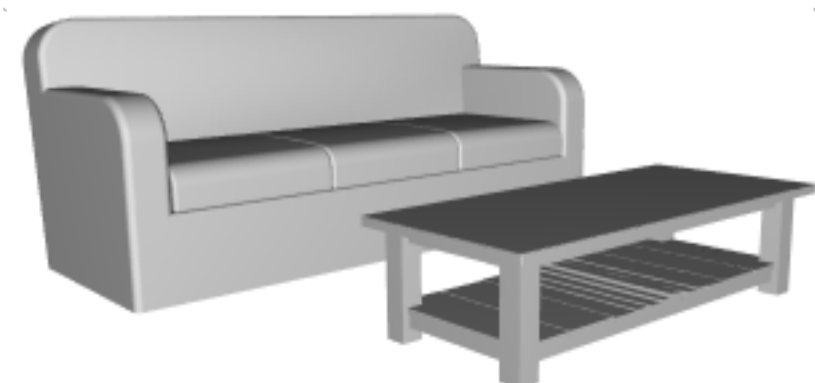



0.272727

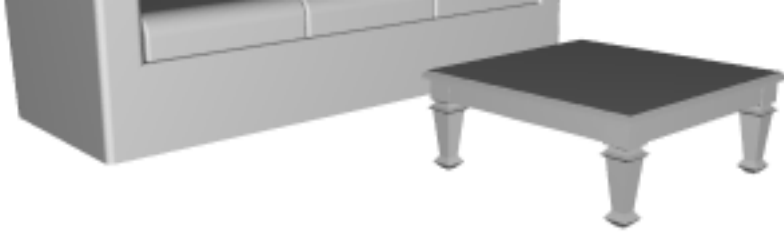

0.181818

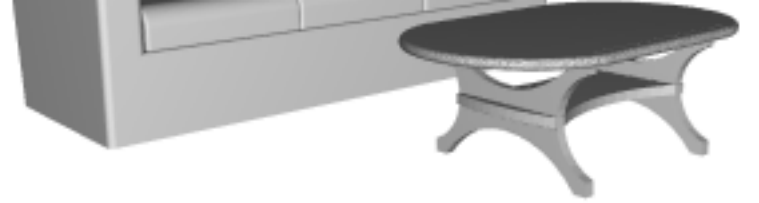

0.181818

Task 41 of 50 Score = 0.73251

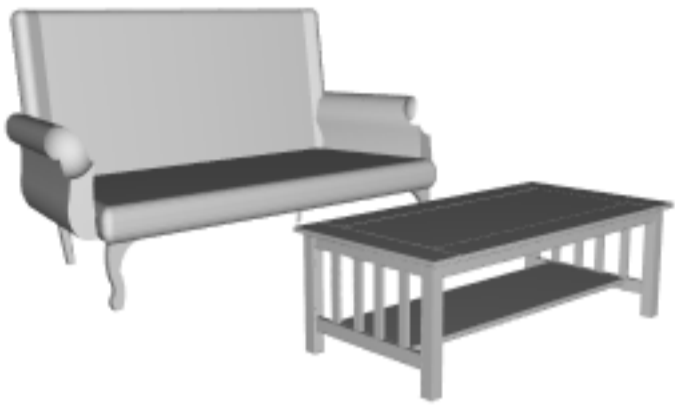

0.545455

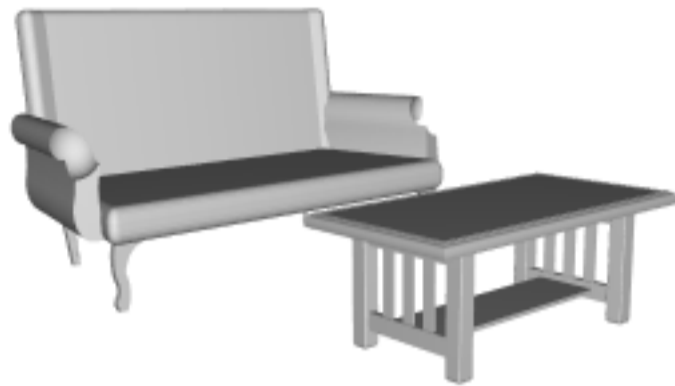

0.454545



0.454545



0.181818

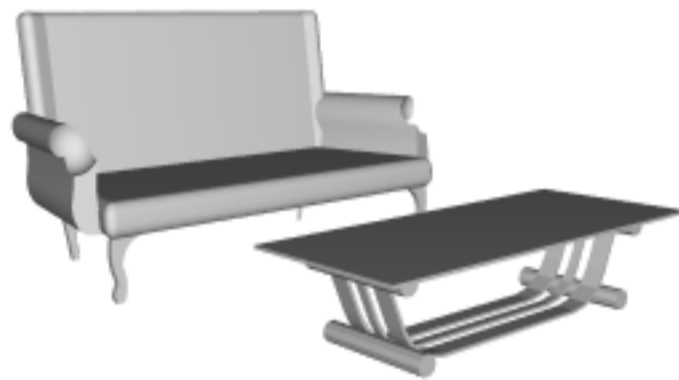

0.181818



0.181818

Task 42 of 50 Score = 0.73251

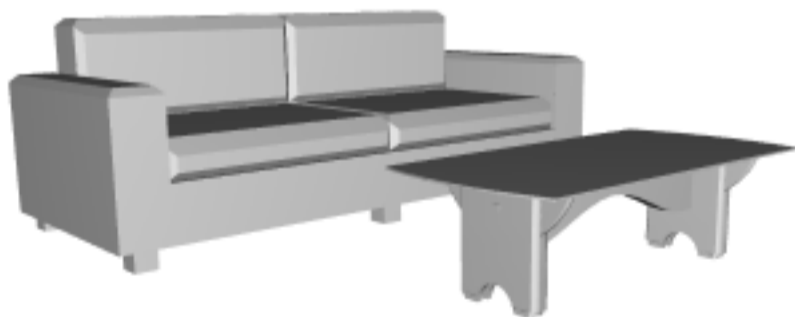

0.545455



0.454545



0.363636



0.272727

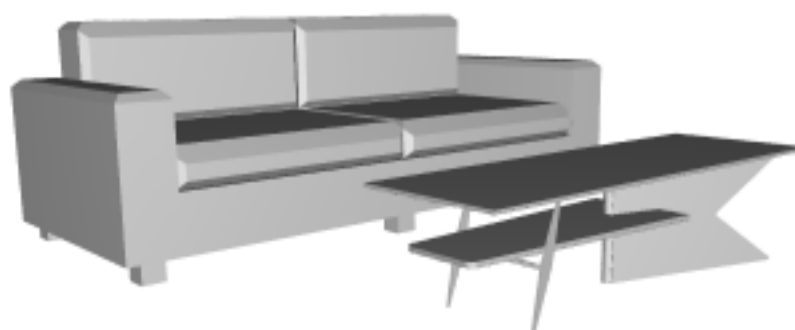

0.272727



0.0909091

Task 43 of 50 Score = 1.33956

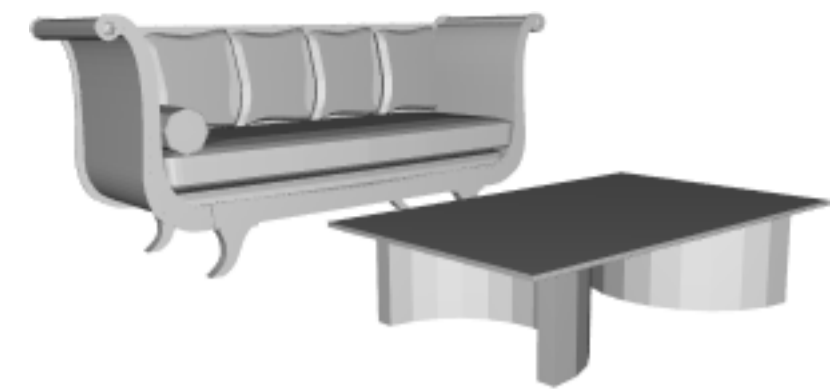

0.444444



0.388889



0.388889

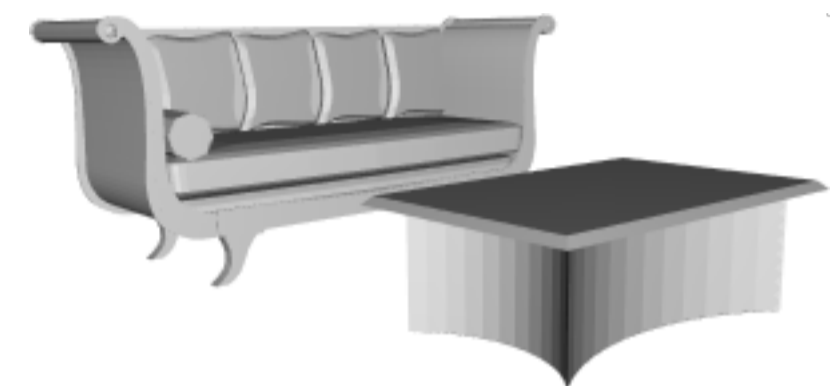

0.333333



0.277778



0.166667

Task 44 of 50 Score = 1.33956



0.444444

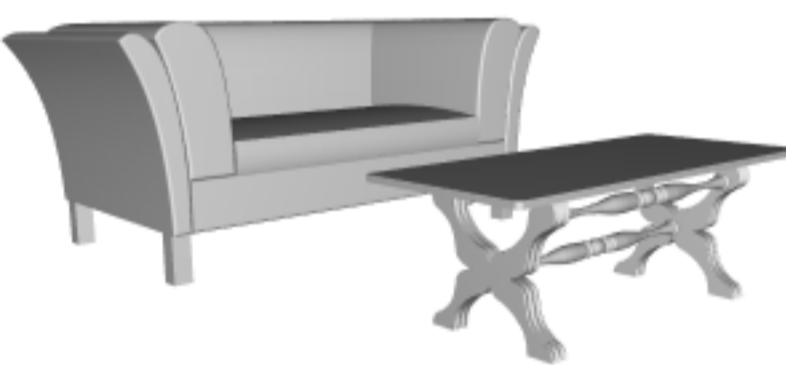

0.444444



0.444444



0.277778



0.222222



0.166667

Task 45 of 50 Score = 1.33956

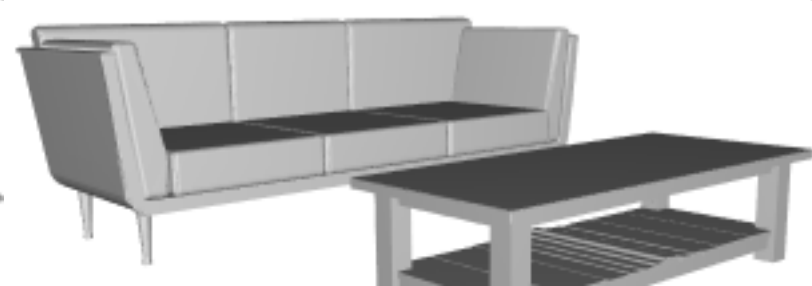
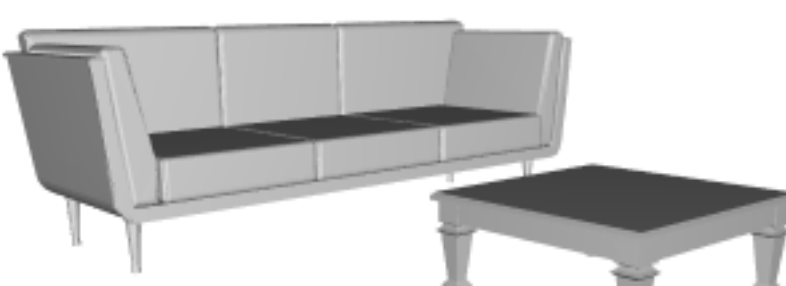

0.444444



0.388889



0.333333



0.277778

0.277778

0.277778

Task 46 of 50 Score = 1.73398



0.454545



0.454545



0.363636

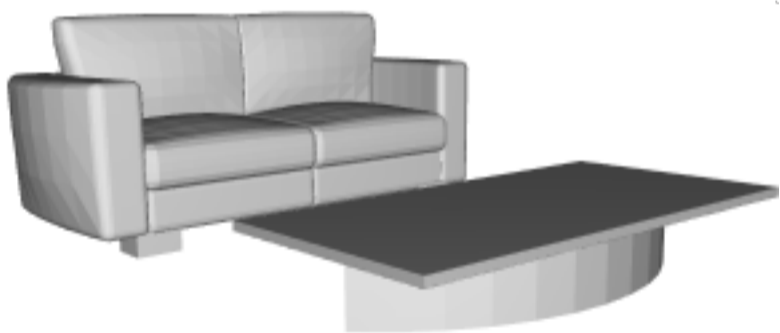

0.363636



0.181818



0.181818

Task 47 of 50 Score = 1.73398

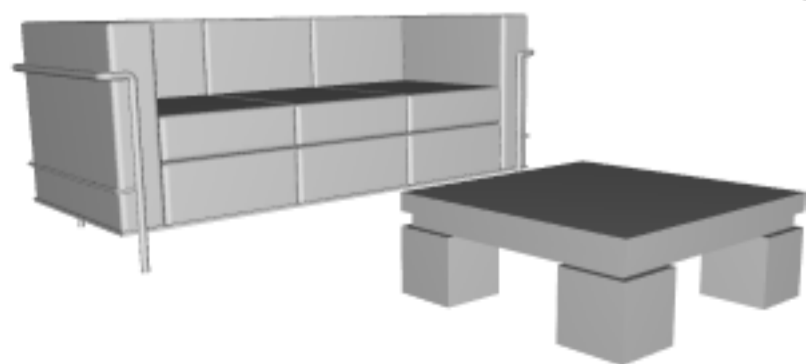

0.454545



0.454545



0.363636

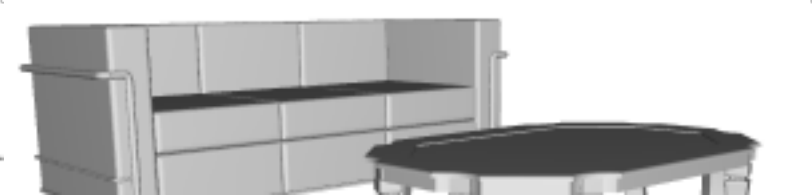
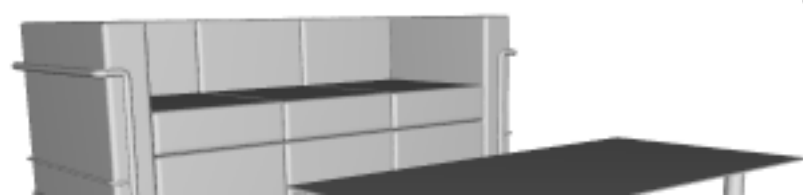
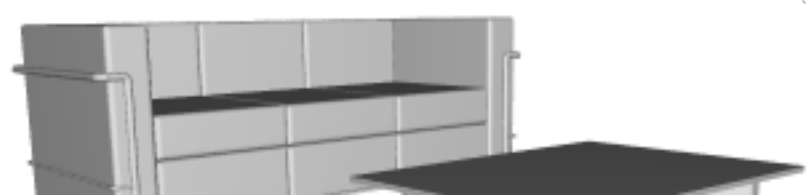



0.363636



0.272727



0.0909091

Task 48 of 50 Score = 1.73398



0.454545



0.454545



0.363636

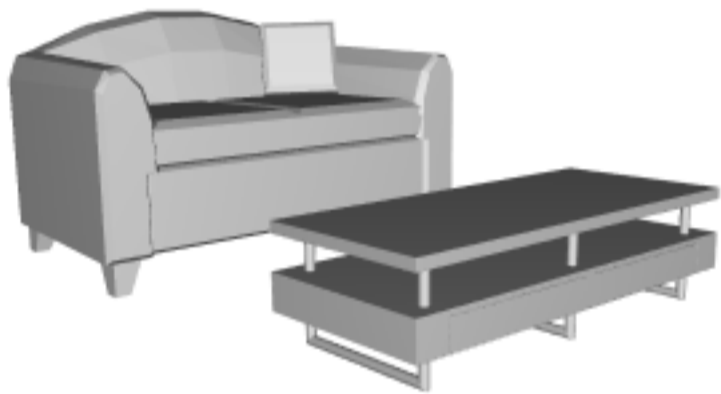

0.363636

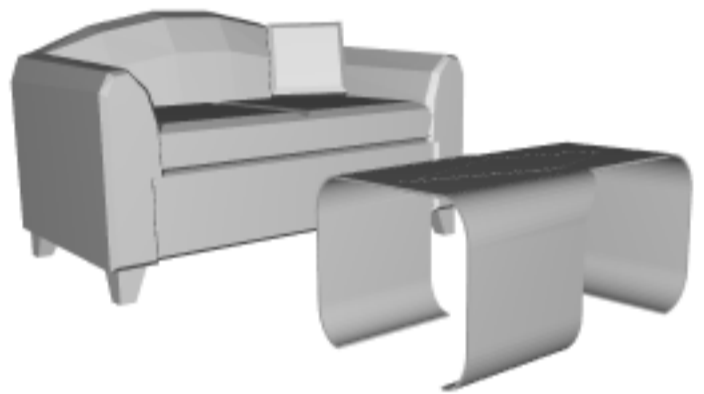

0.272727



0.0909091

Task 49 of 50 Score = 1.73398



0.454545



0.454545

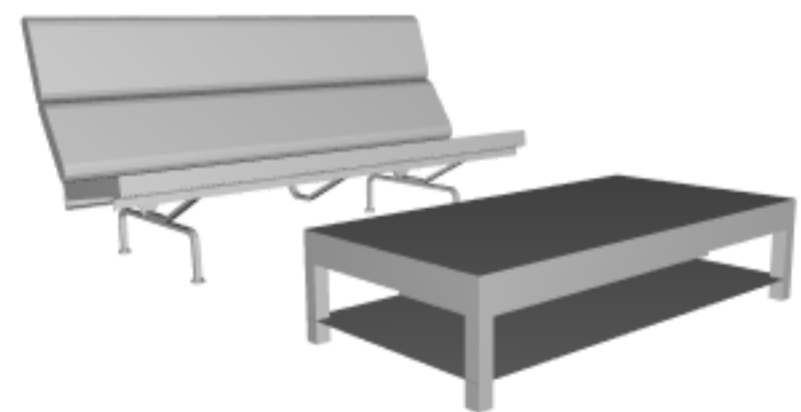

0.363636



0.363636



0.181818



0.181818

Task 50 of 50 Score = 1.73398



0.454545

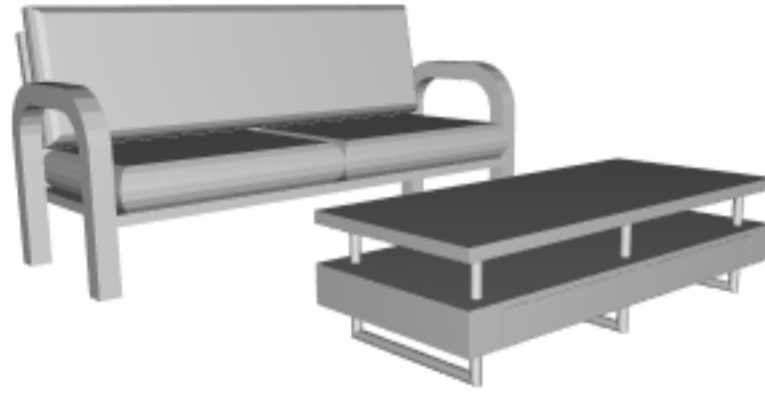

0.454545



0.272727



0.272727

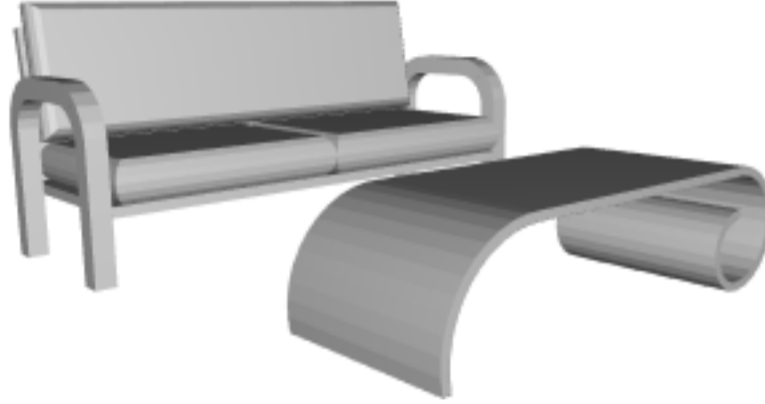

0.272727

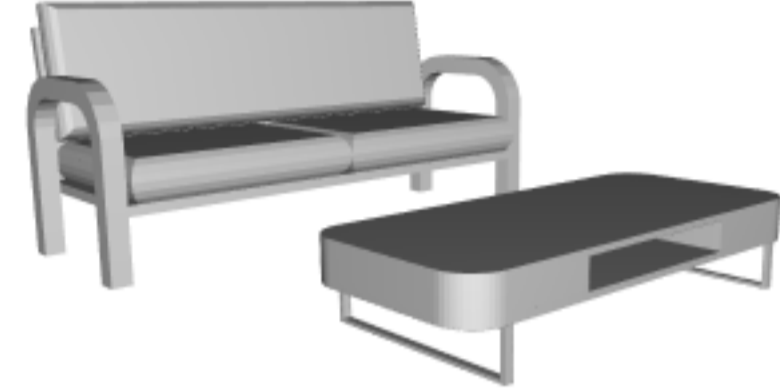

0.272727
