

Task 1 of 50 Score = 0.000779014

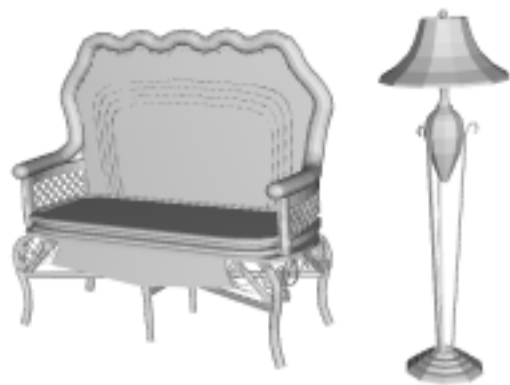

0.909091

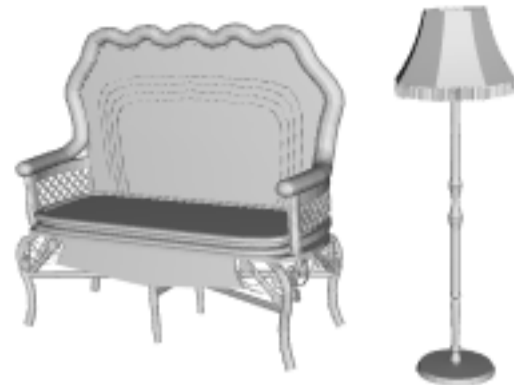

0.727273

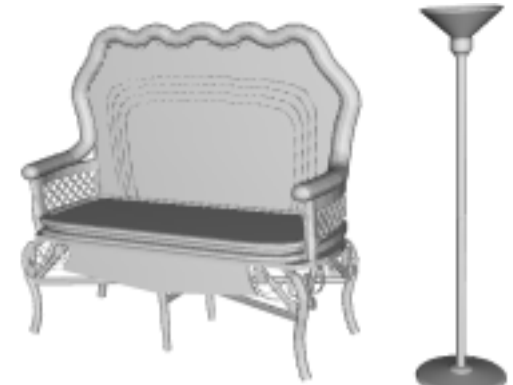

0.0909091

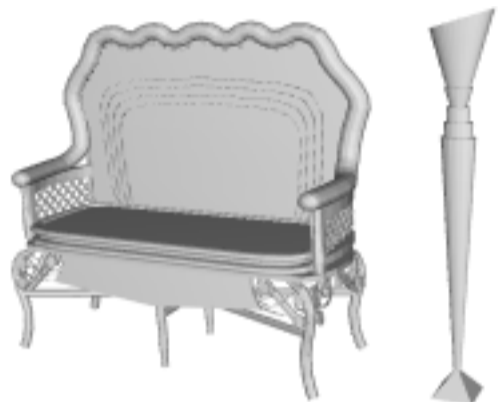

0.0909091

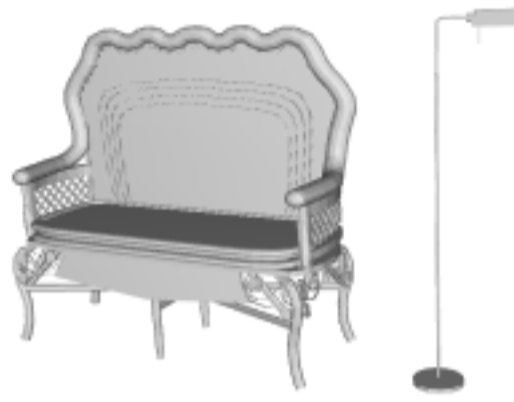

0.0909091

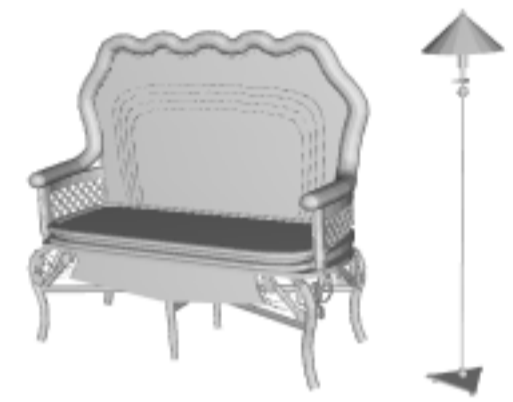

0.0909091

Task 2 of 50 Score = 0.00326283



0.833333



0.666667



0.166667



0.166667



0.0833333



0.0833333

Task 3 of 50 Score = 0.00326283



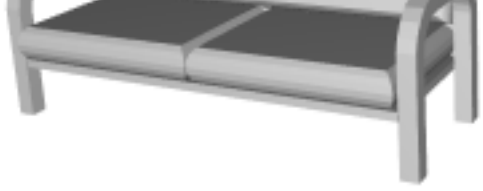

0.833333

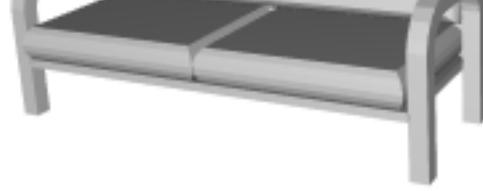

0.5

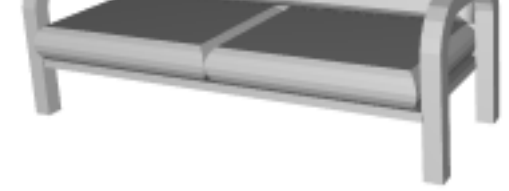

0.25



0.166667



0.166667



0.0833333

Task 4 of 50 Score = 0.00326283



0.833333



0.666667



0.25



0.166667



0.0833333



0

Task 5 of 50 Score = 0.00326283



0.833333



0.666667



0.25





0.166667



0.0833333



0

Task 6 of 50 Score = 0.00326283

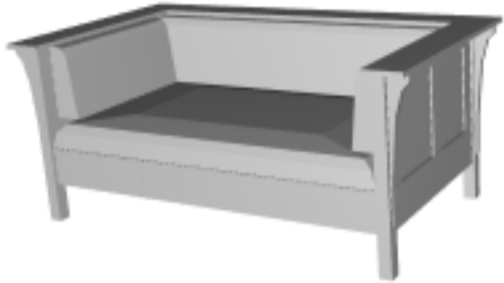

0.833333

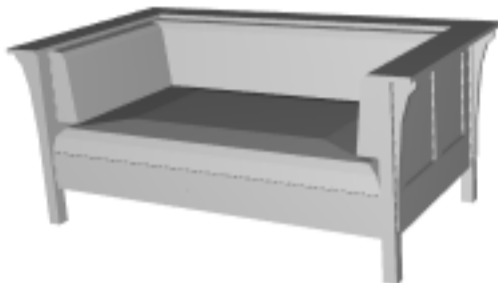

0.5

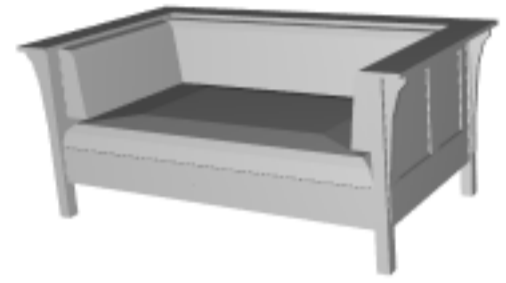

0.333333

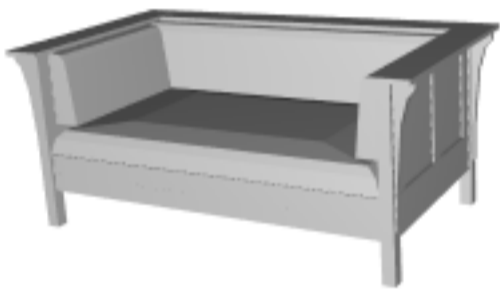

0.166667

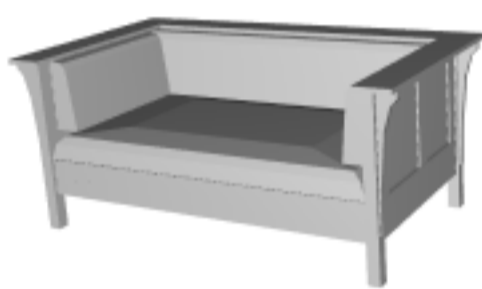

0.0833333

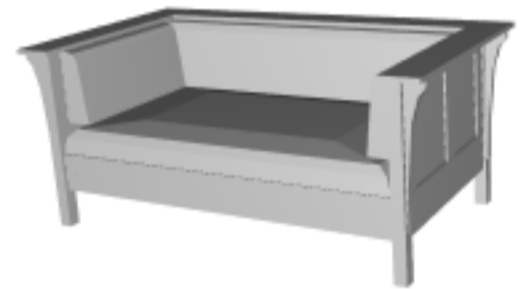

0.0833333

Task 7 of 50 Score = 0.00326283

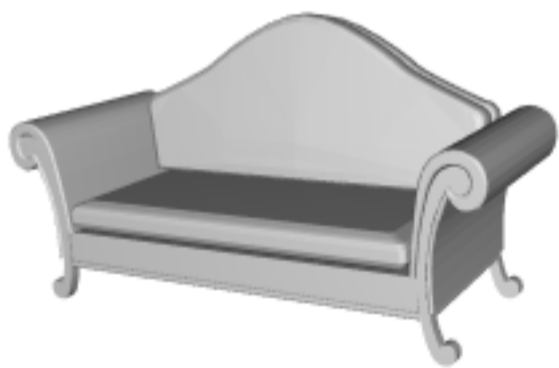

0.833333

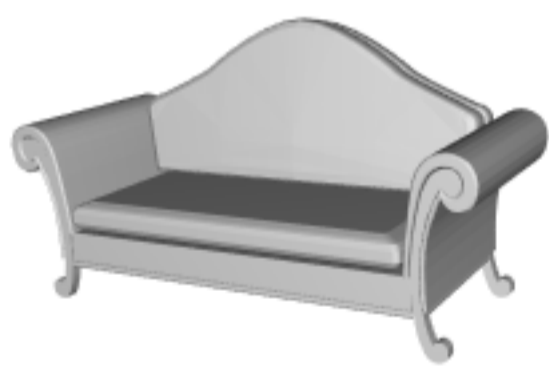

0.583333

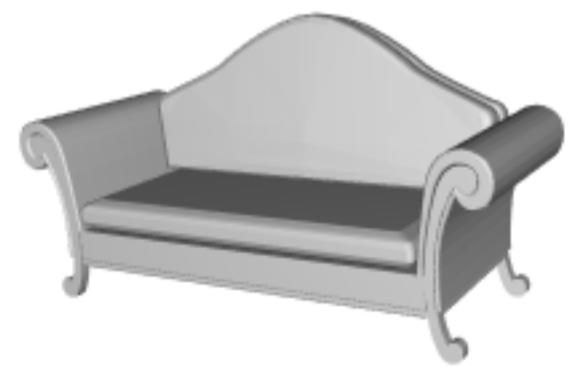

0.333333

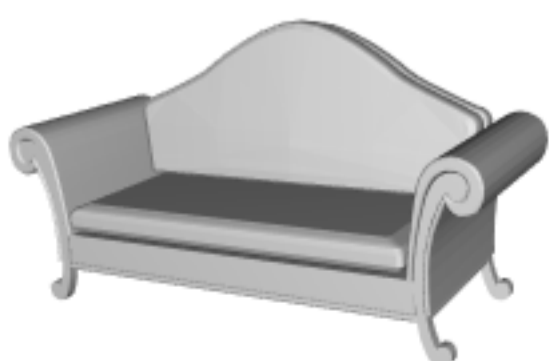

0.166667

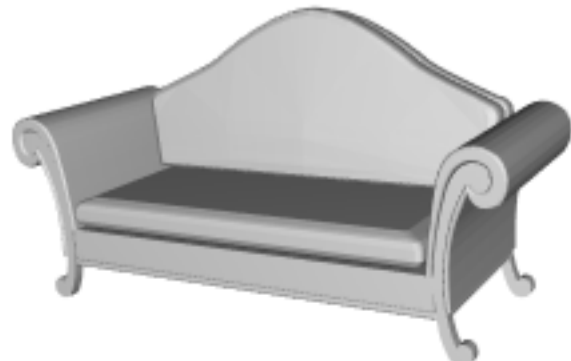

0.0833333

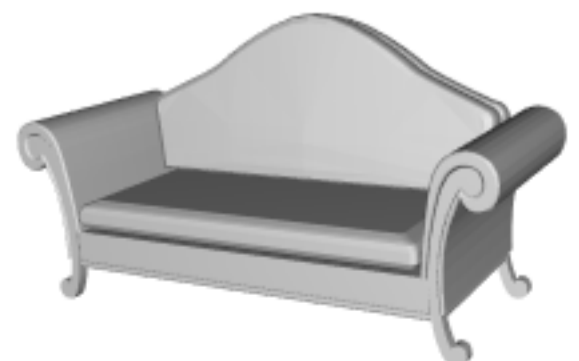

0

Task 8 of 50 Score = 0.00823045

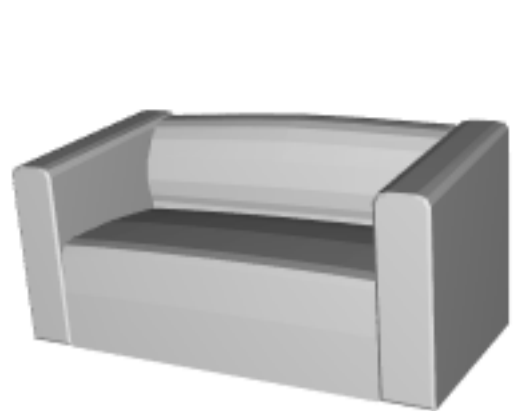

0.818182

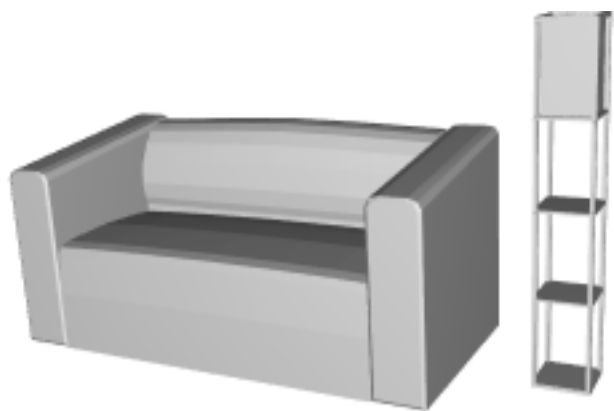

0.818182

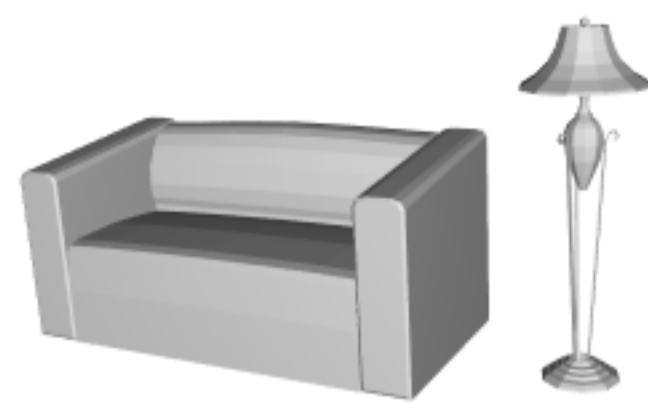

0.181818

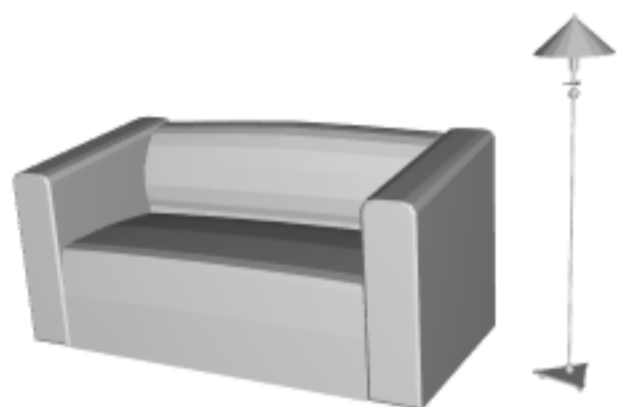

0.0909091

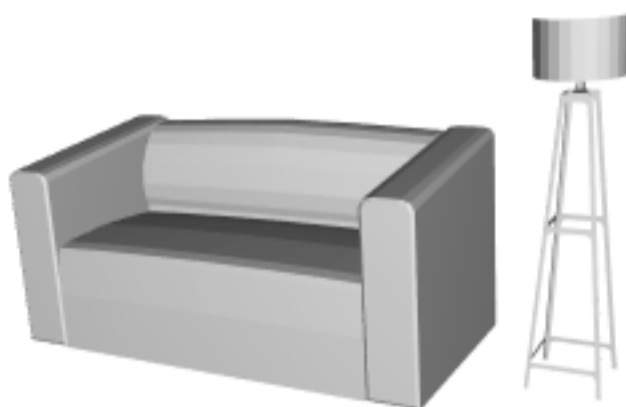

0.0909091

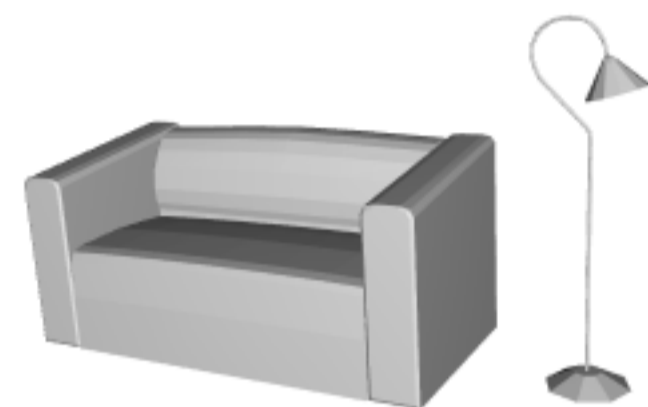

0

Task 9 of 50 Score = 0.00823045



0.818182



0.363636



0.272727



0.181818



0.181818



0.181818

Task 10 of 50 Score = 0.00823045



0.818182

0.454545

0.272727

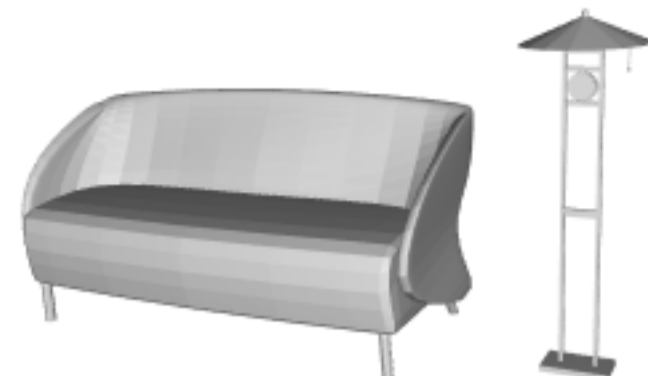
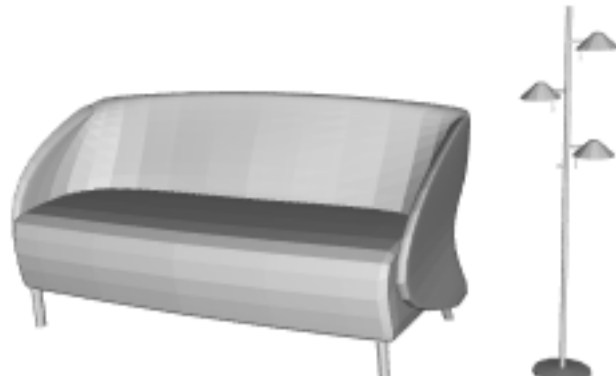
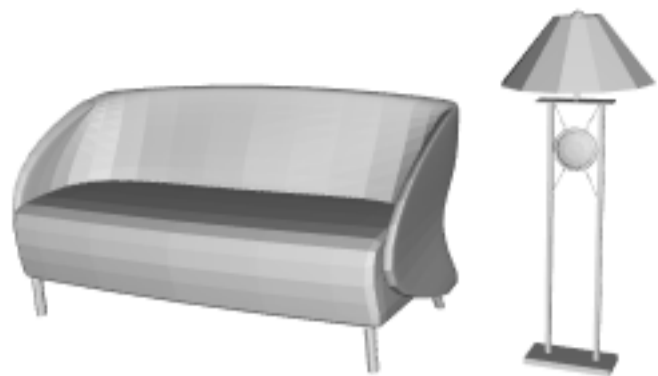

0.272727

0.181818

0

Task 11 of 50 Score = 0.0231333



0.75

0.416667

0.333333

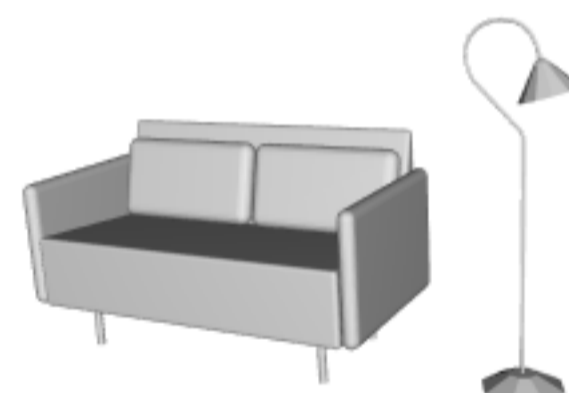

0.25

0.166667

0.0833333

Task 12 of 50 Score = 0.0231333

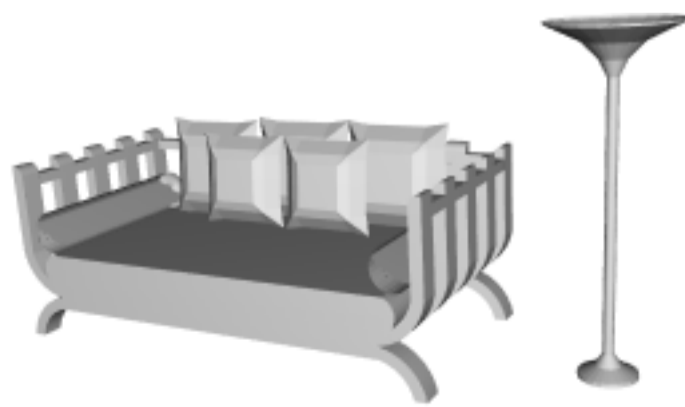

0.75

0.583333

0.25





0.25



0.166667



0

Task 13 of 50 Score = 0.0231333



0.75



0.5



0.25



0.25



0.166667

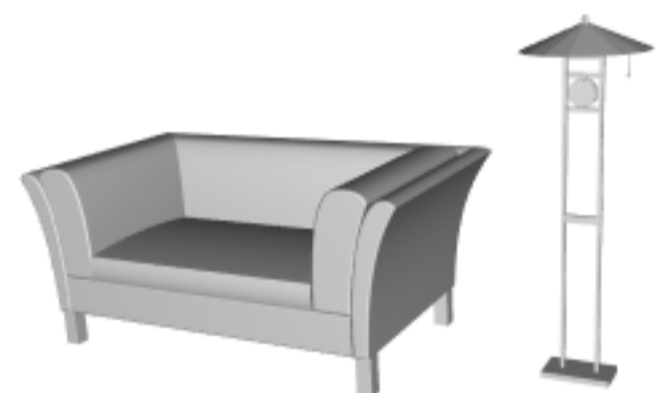

0.0833333

Task 14 of 50 Score = 0.0529391



0.727273

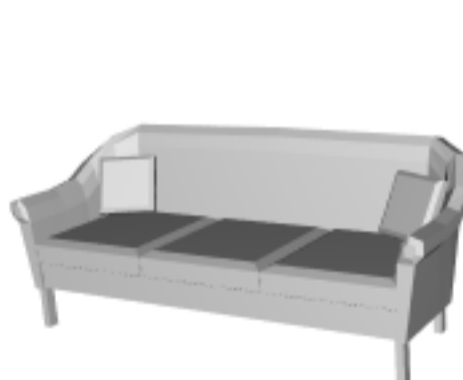

0.545455



0.363636

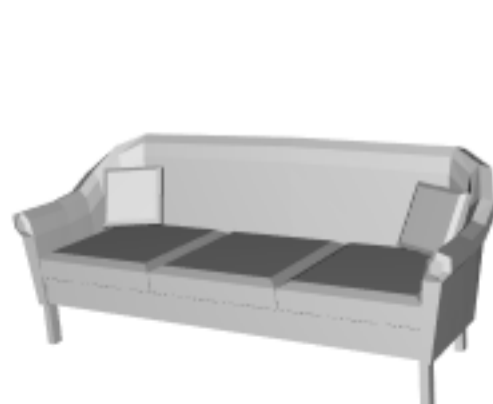

0.181818



0.0909091



0.0909091

Task 15 of 50 Score = 0.0529391



0.727273



0.545455



0.272727

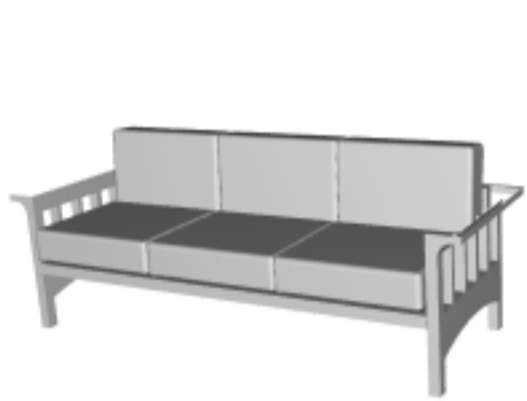

0.272727

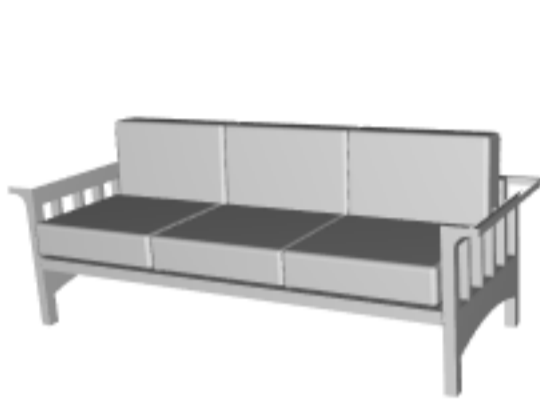

0.0909091



0.0909091

Task 16 of 50 Score = 0.112551



0.666667



0.5



0.333333



0.25



0.25



0

Task 17 of 50 Score = 0.112551

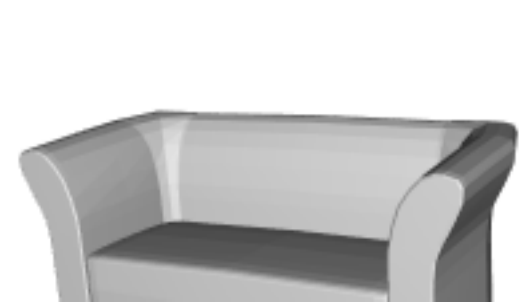
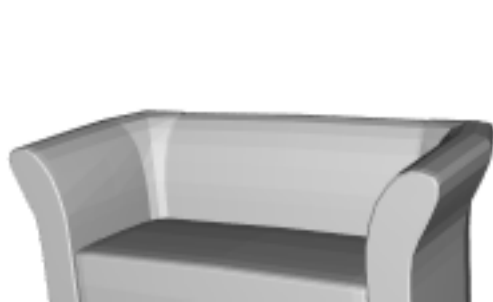
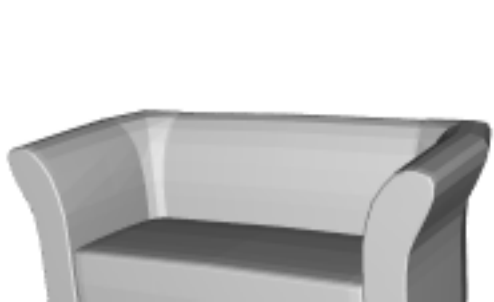

0.66667

0.5

0.25

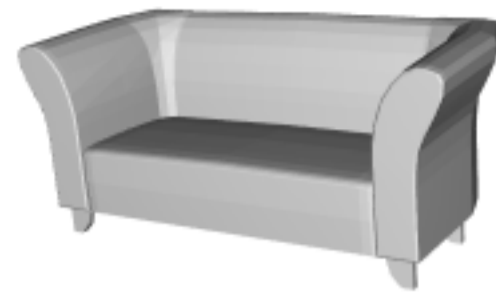
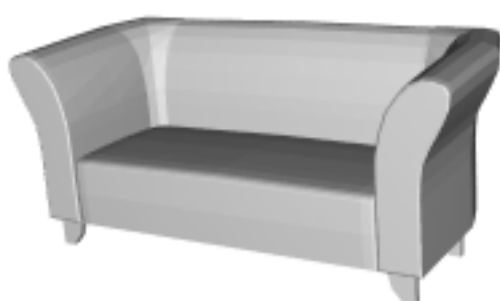
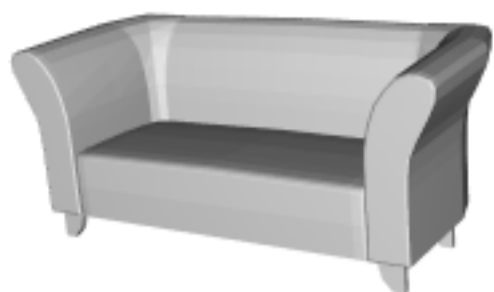

0.25

0.16667

0.16667

Task 18 of 50 Score = 0.112551



0.66667

0.41667

0.33333



0.25

0.16667

0.16667

Task 19 of 50 Score = 0.112551



0.66667

0.5

0.41667





0.25



0.0833333



0.0833333

Task 20 of 50 Score = 0.231774



0.636364

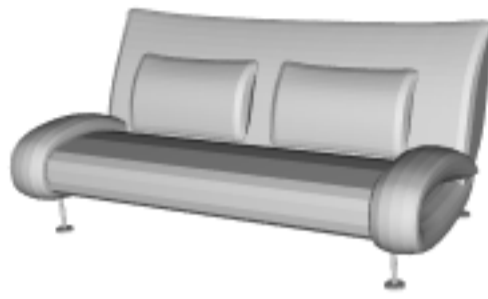

0.545455

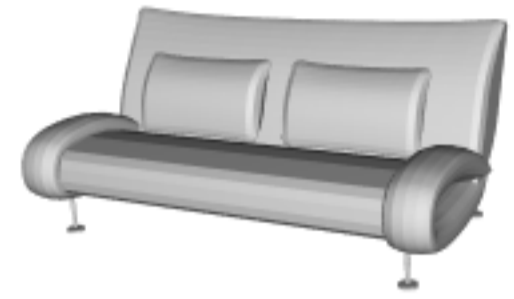

0.454545



0.272727

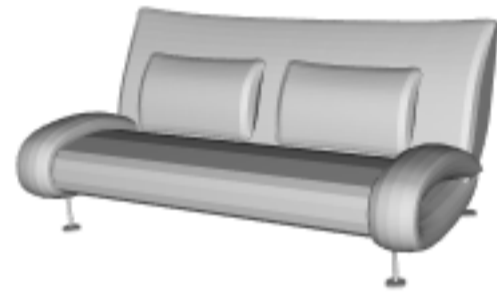

0.0909091

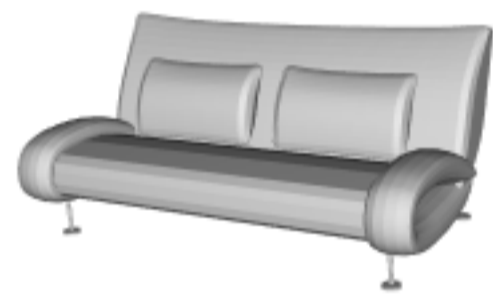

0

Task 21 of 50 Score = 0.231774

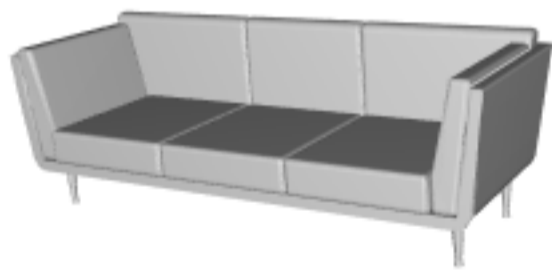

0.636364

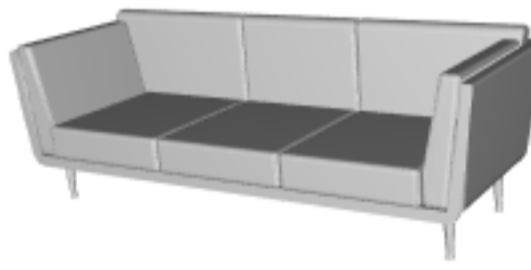

0.545455

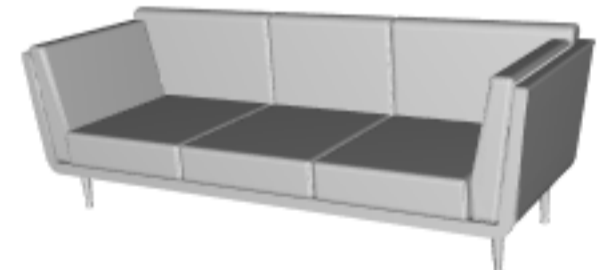

0.363636

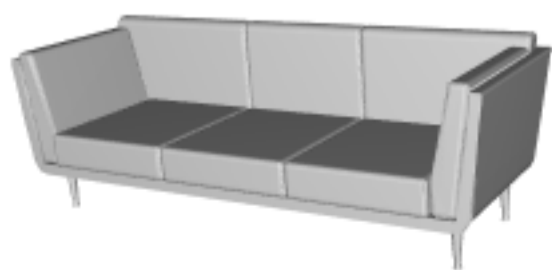

0.181818

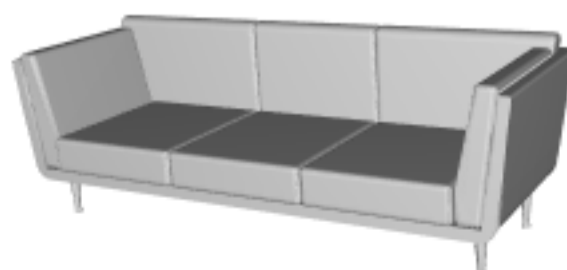

0.181818

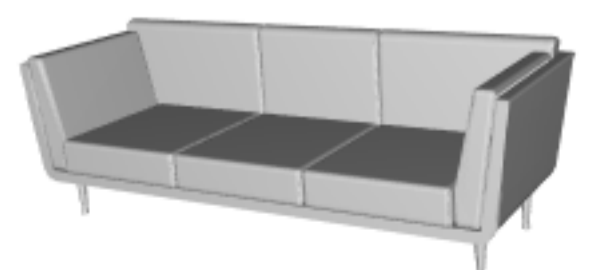

0.0909091

Task 22 of 50 Score = 0.231774

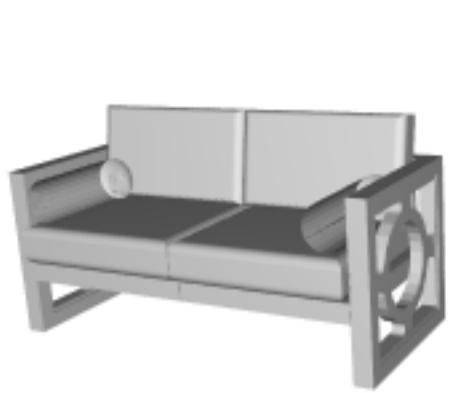

0.636364



0.545455

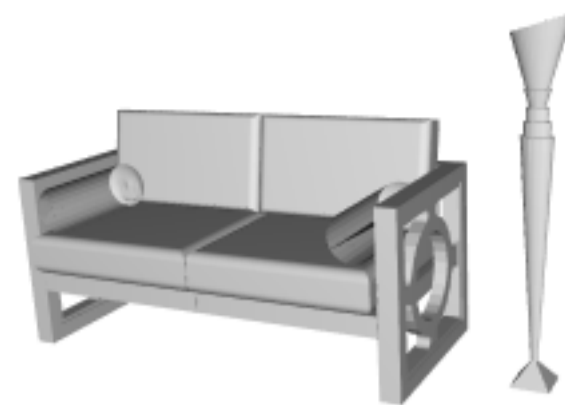

0.272727



0.272727

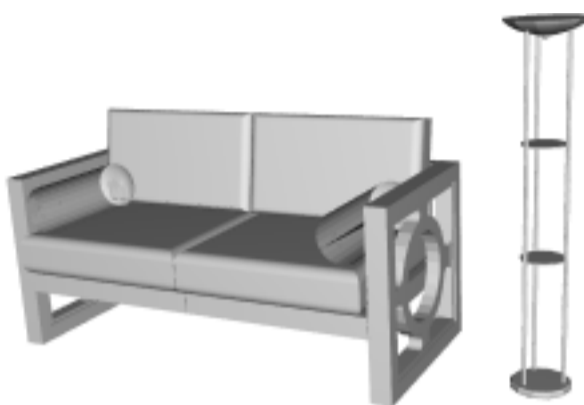

0.181818

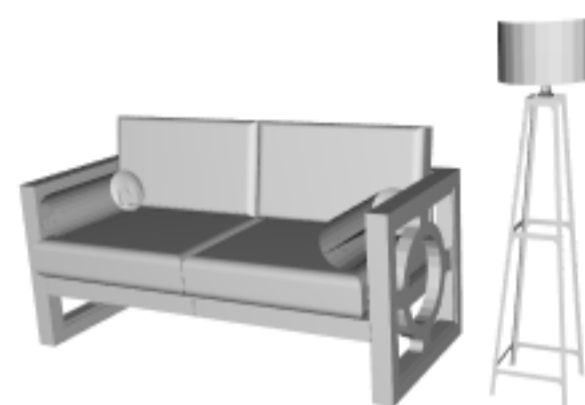

0.0909091

Task 23 of 50 Score = 0.231774



0.636364



0.363636



0.363636



0.272727



0.181818

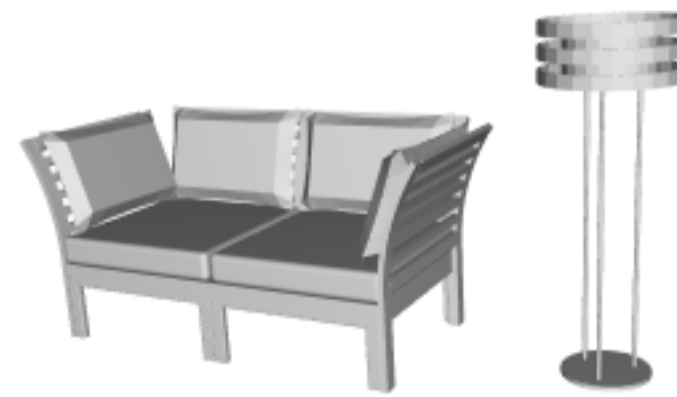

0.181818

Task 24 of 50 Score = 0.231774

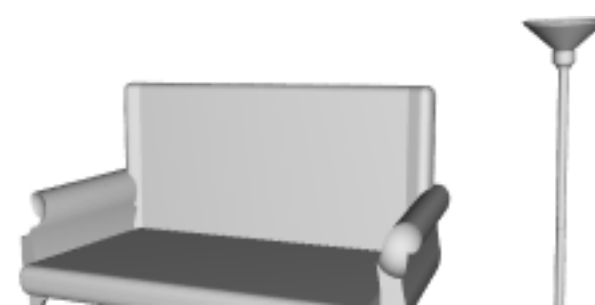
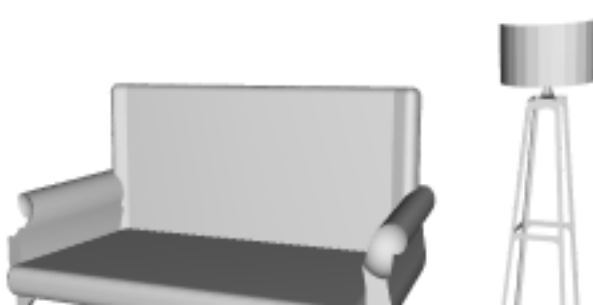
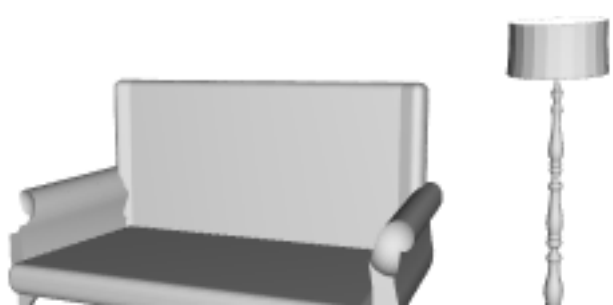

0.636364

0.454545

0.272727



0.272727

0.181818

0.181818

Task 25 of 50 Score = 0.231774

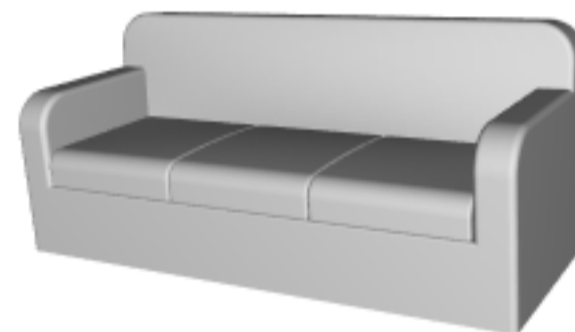
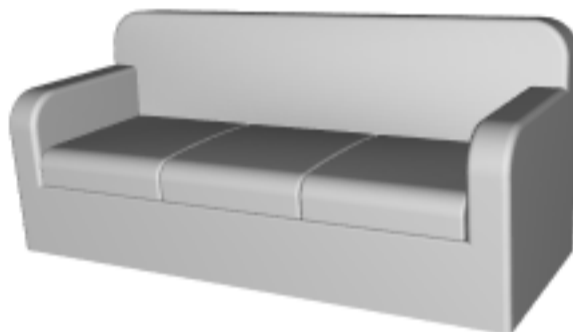
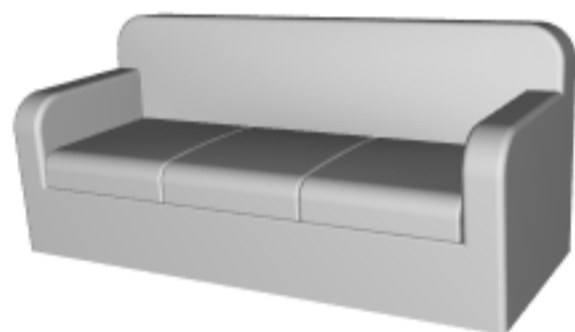

0.636364

0.454545

0.363636

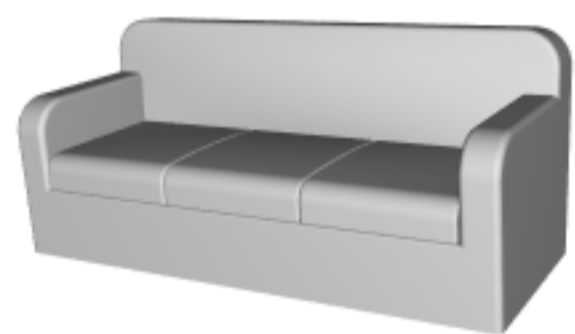
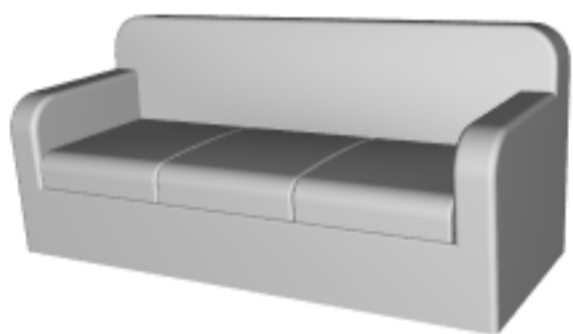
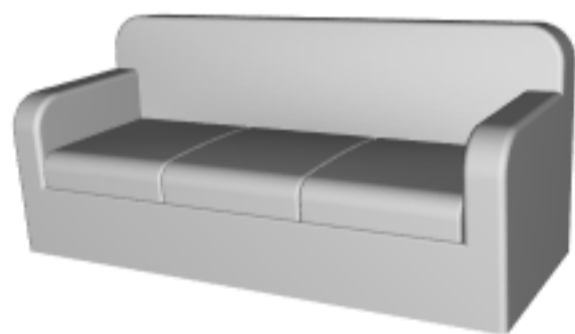

0.363636

0.181818

0

Task 26 of 50 Score = 0.231774



0.636364

0.545455

0.272727





0.272727



0.181818



0.0909091

Task 27 of 50 Score = 0.231774



0.636364

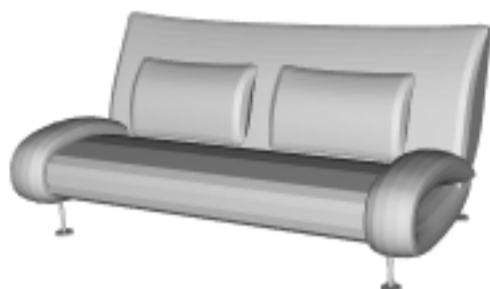

0.545455

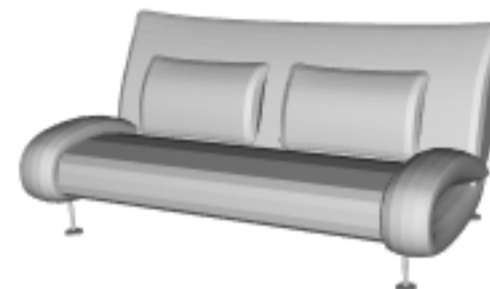

0.454545



0.363636

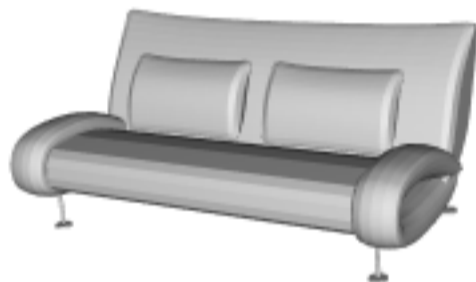

0

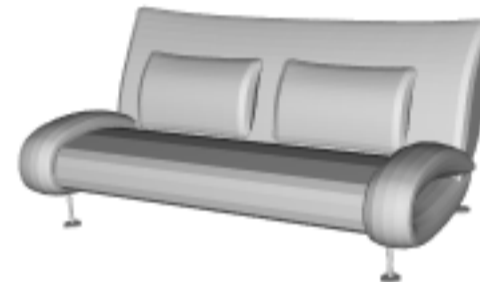

0



Task 28 of 50 Score = 0.398686

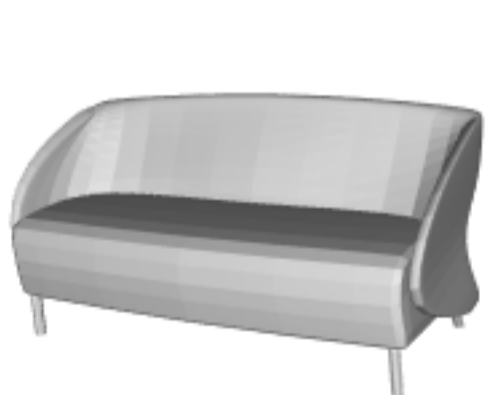

0.583333

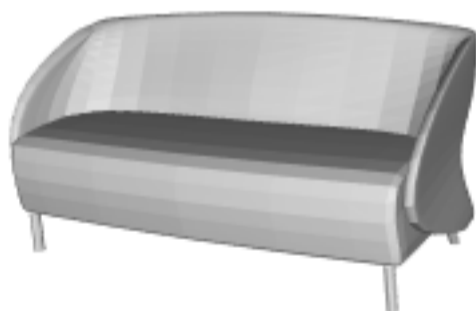

0.5

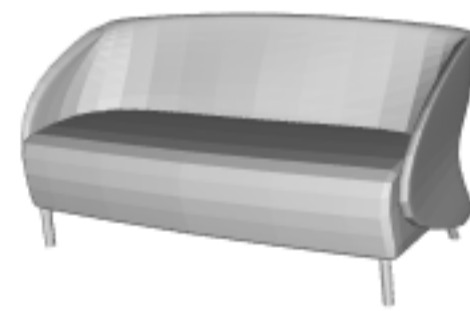

0.333333

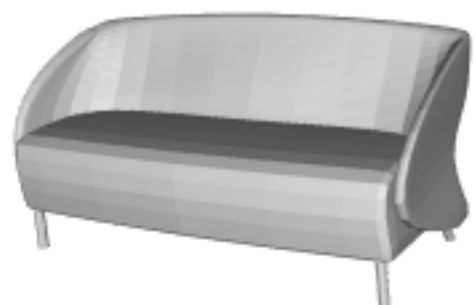

0.25

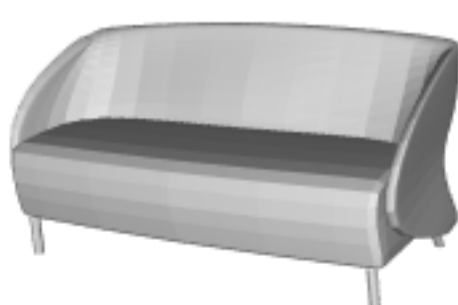

0.166667

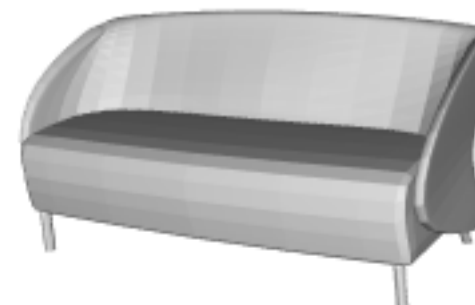

0.166667



Task 29 of 50 Score = 0.398686



0.583333

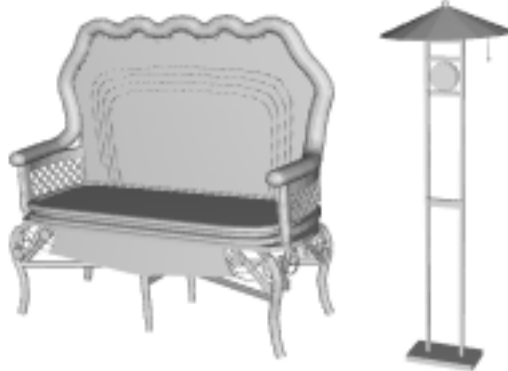

0.5



0.333333

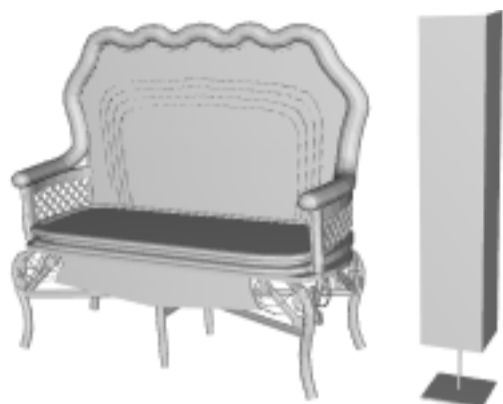

0.25

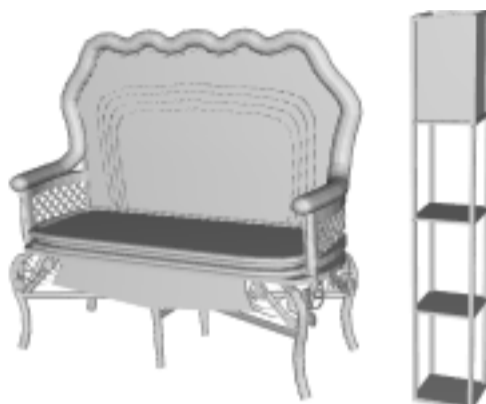

0.25

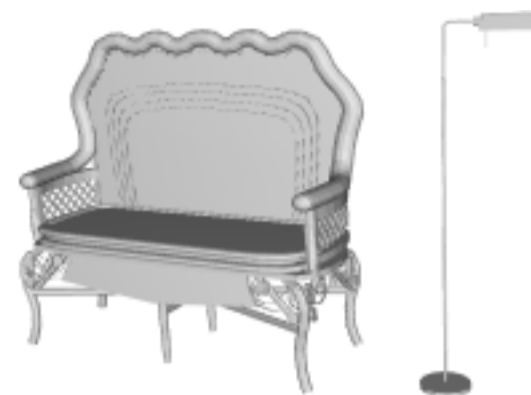

0.0833333

Task 30 of 50 Score = 0.398686



0.583333



0.5



0.333333



0.25



0.166667



0.166667

Task 31 of 50 Score = 0.398686

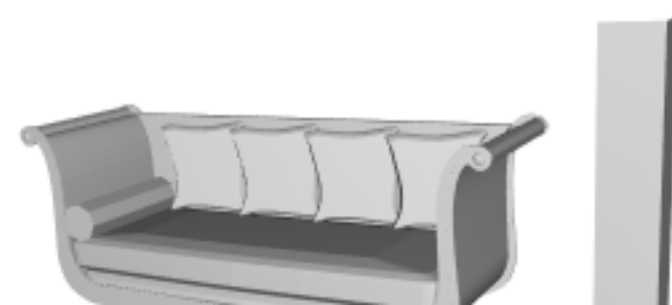
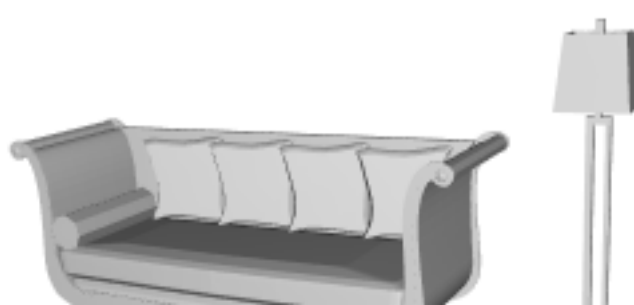
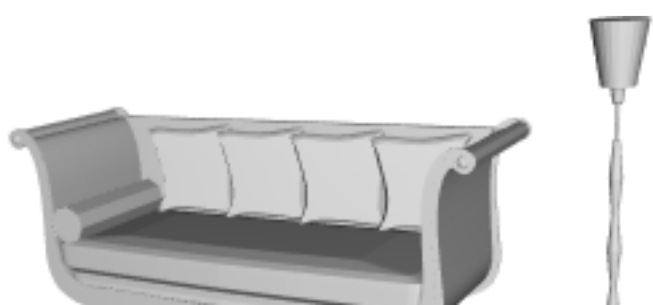

0.583333

0.416667

0.333333



0.25

0.25

0.166667

Task 32 of 50 Score = 0.398686

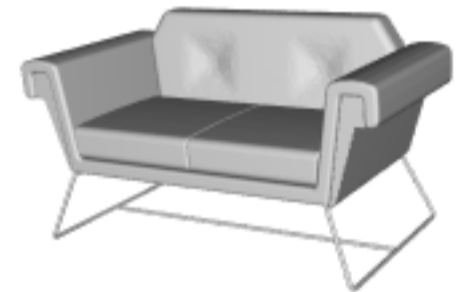
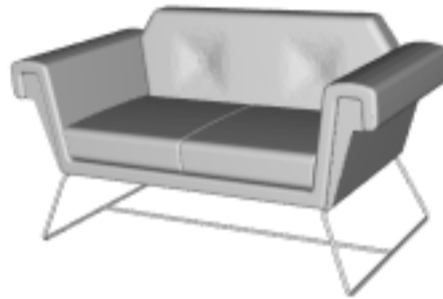
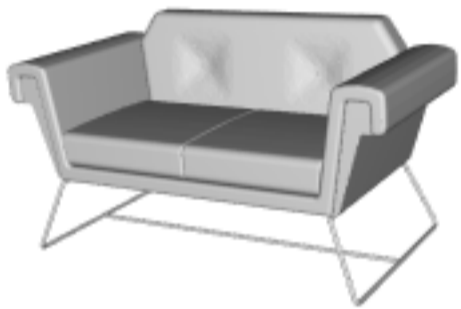

0.583333

0.416667

0.333333

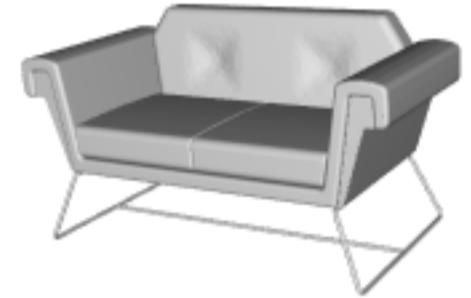
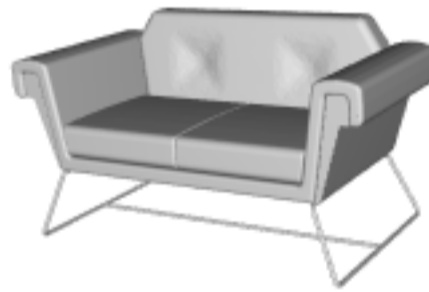

0.333333

0.25

0.0833333

Task 33 of 50 Score = 0.398686

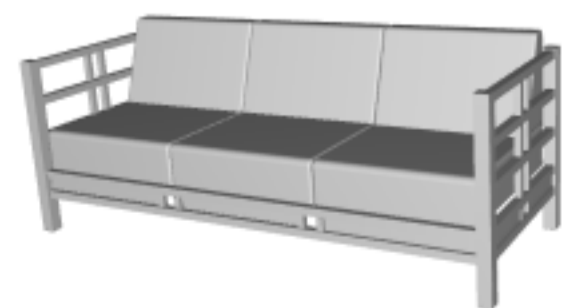
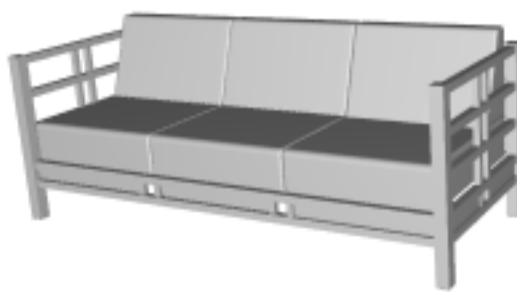
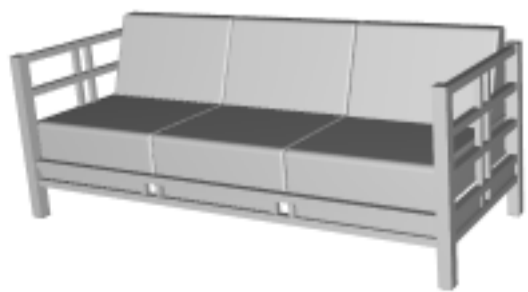

0.583333

0.583333

0.25



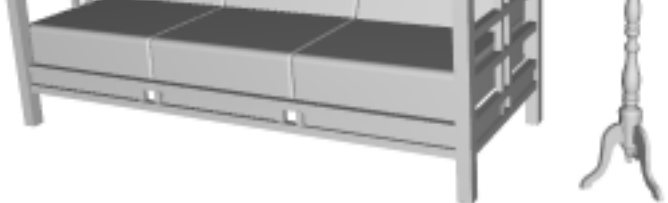

0.25

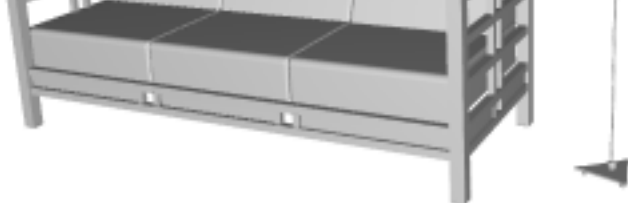

0.166667

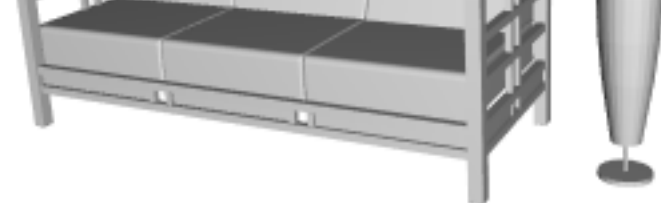

0.166667

Task 34 of 50 Score = 0.398686



0.583333



0.416667



0.333333



0.25



0.25



0.166667

Task 35 of 50 Score = 0.73251

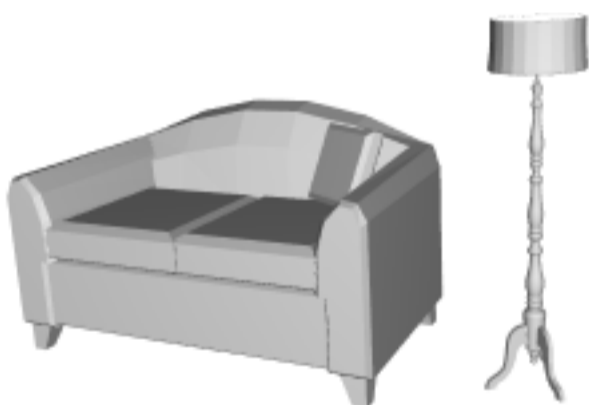

0.545455

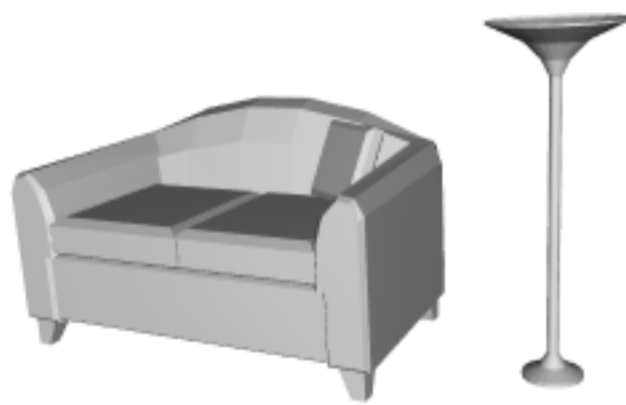

0.454545



0.454545

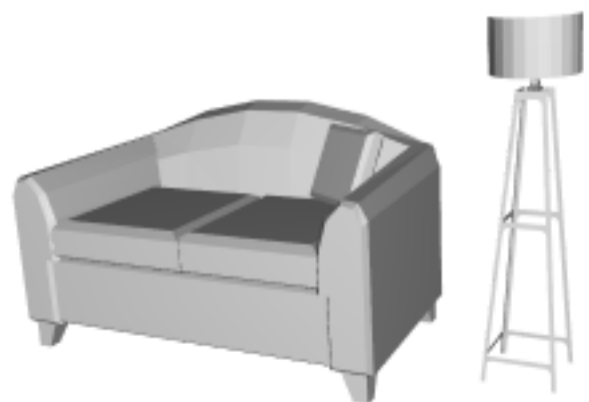

0.454545

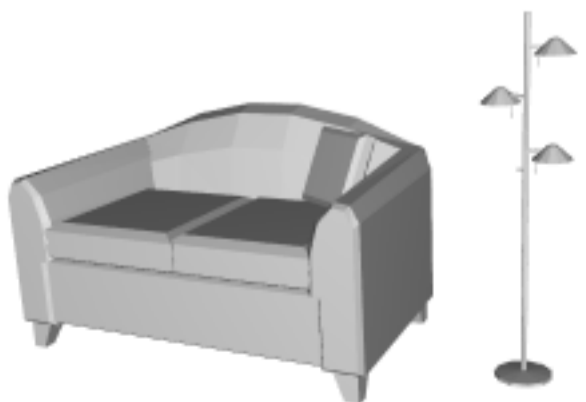

0.0909091

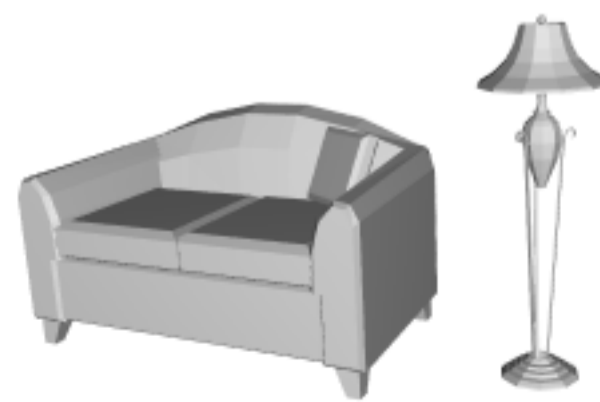

0

Task 36 of 50 Score = 0.73251



0.545455



0.454545



0.363636



0.363636



0.181818



0.0909091

Task 37 of 50 Score = 0.73251

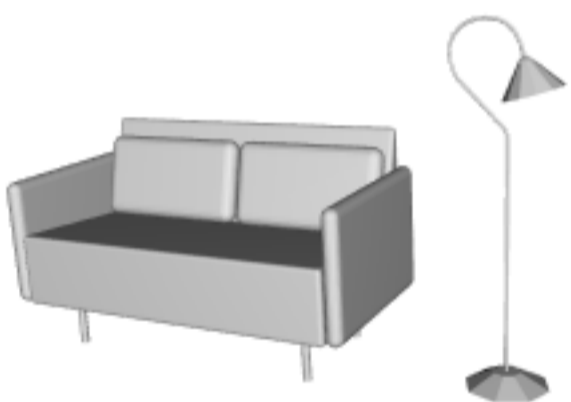

0.545455

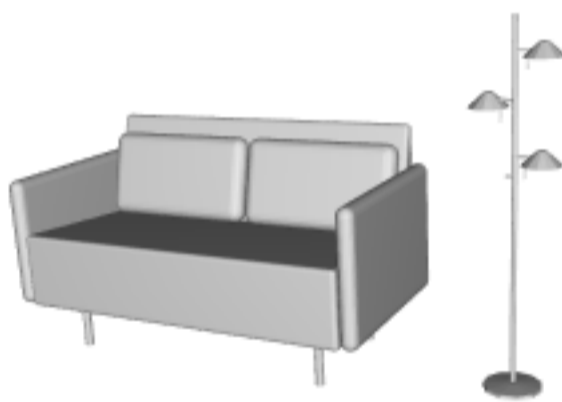

0.363636

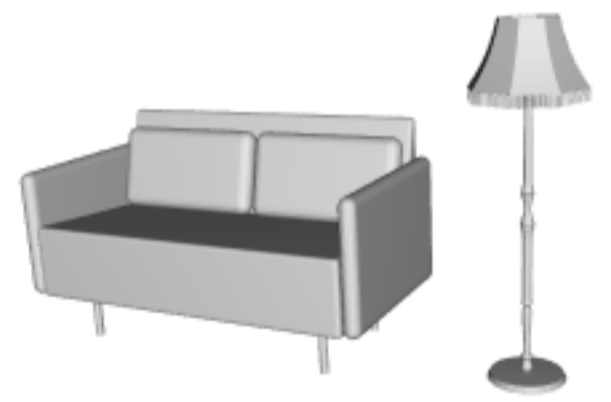

0.272727



0.272727

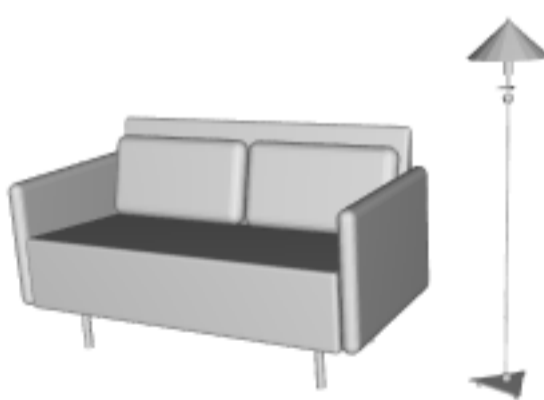

0.272727

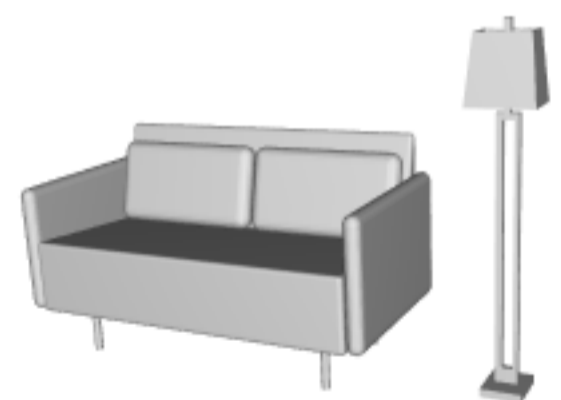

0.272727

Task 38 of 50 Score = 0.73251

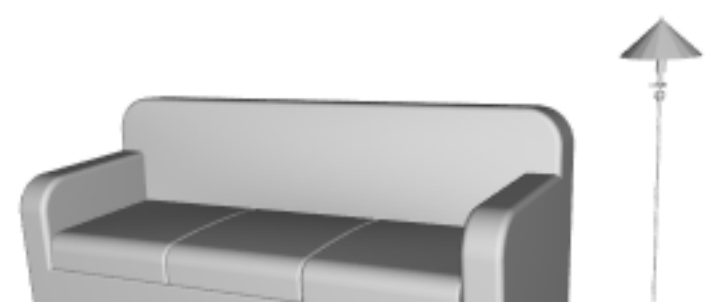
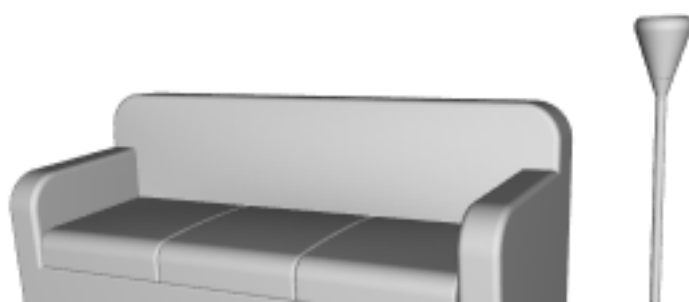
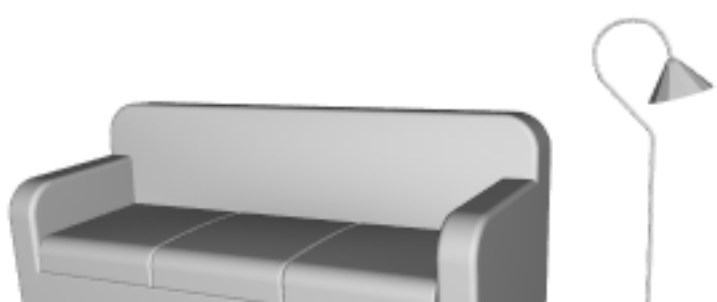

0.545455

0.454545

0.454545

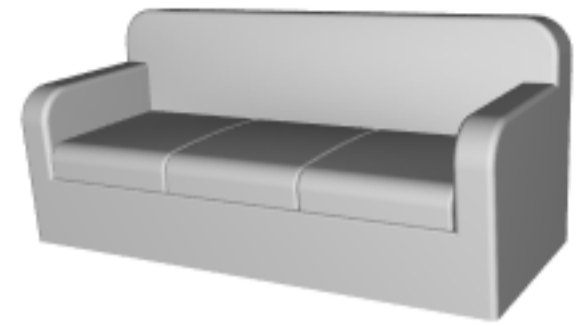
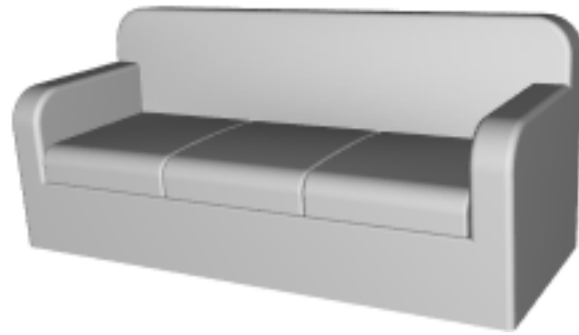
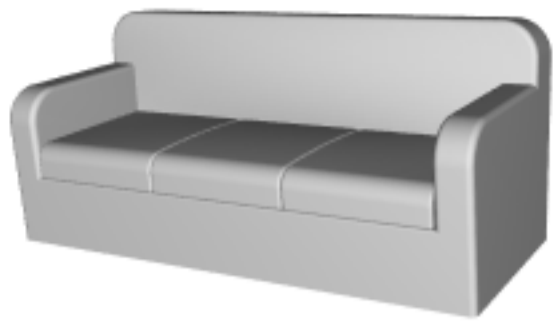

0.181818

0.181818

0.181818

Task 39 of 50 Score = 0.73251

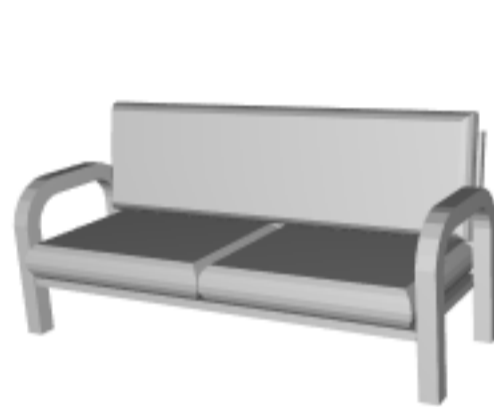
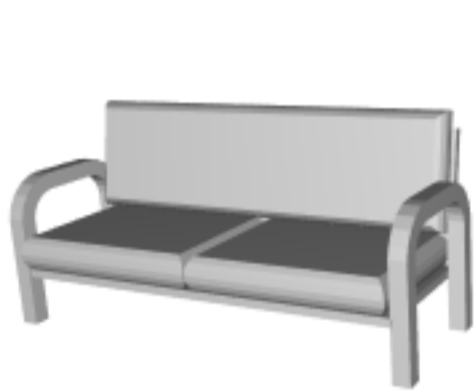

0.545455

0.363636

0.363636

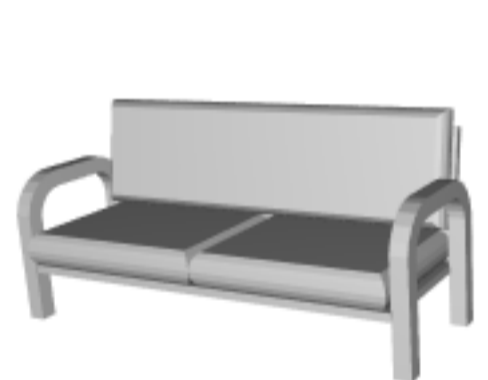
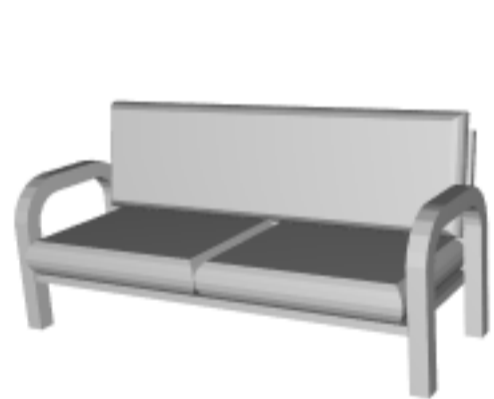
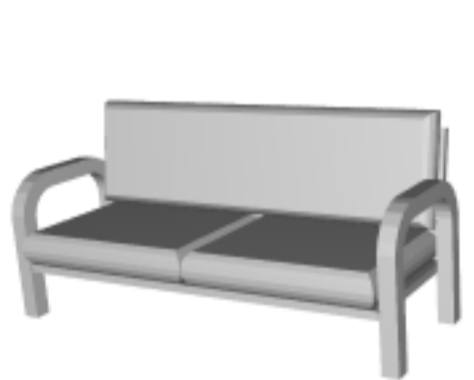

0.272727

0.272727

0.181818

Task 40 of 50 Score = 1.06633



0.5

0.416667

0.416667



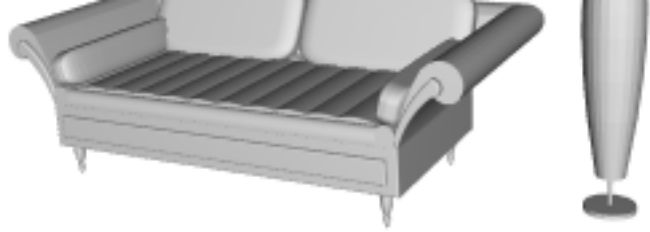

0.25



0.25

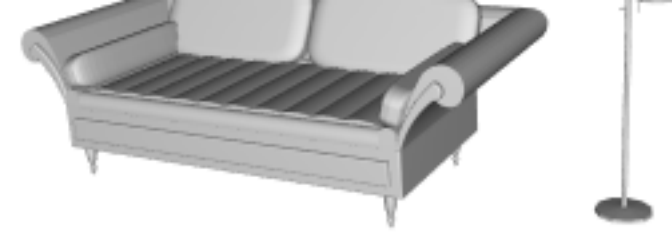

0.166667

Task 41 of 50 Score = 1.06633

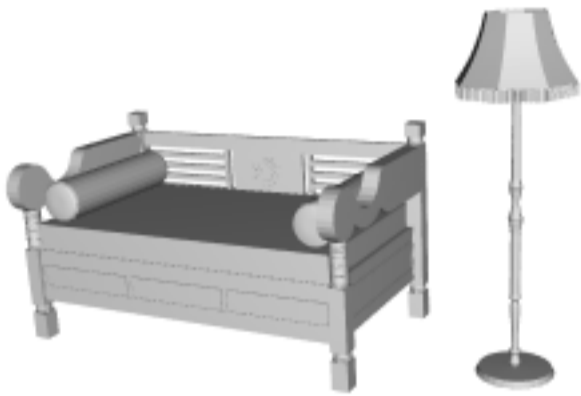

0.5

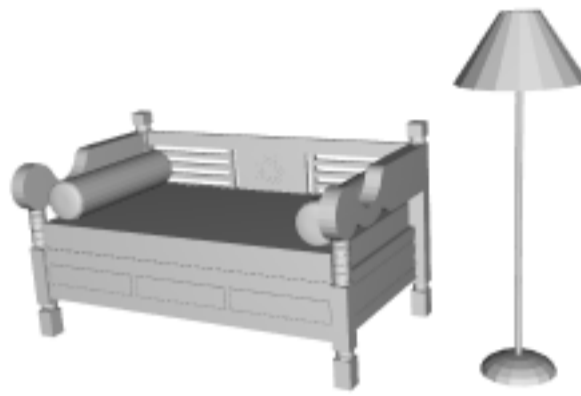

0.5

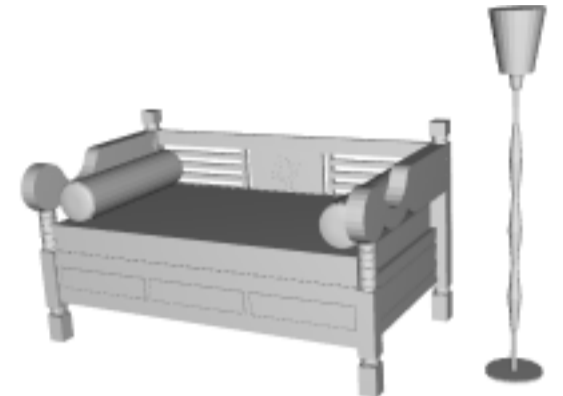

0.333333

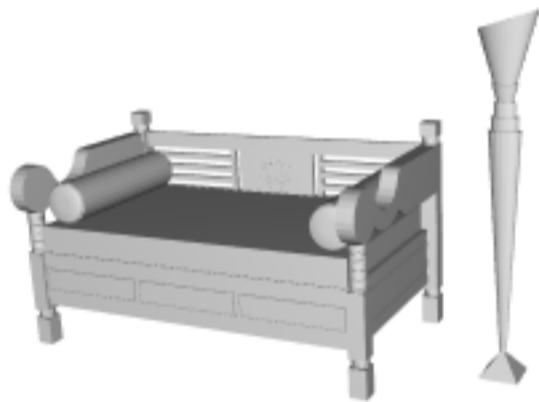

0.25

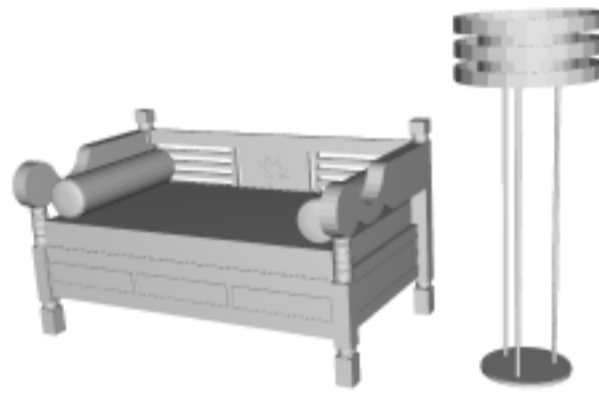

0.25

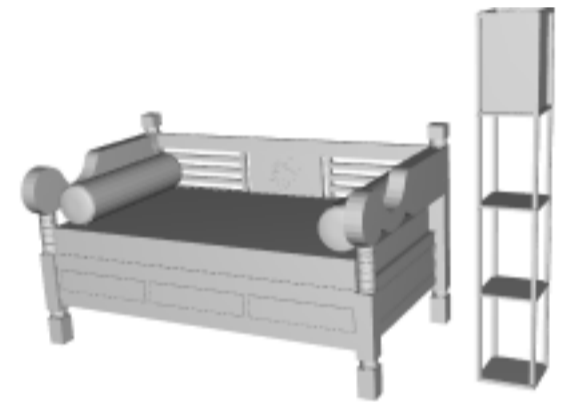

0.166667

Task 42 of 50 Score = 1.06633



0.5



0.416667



0.333333



0.333333

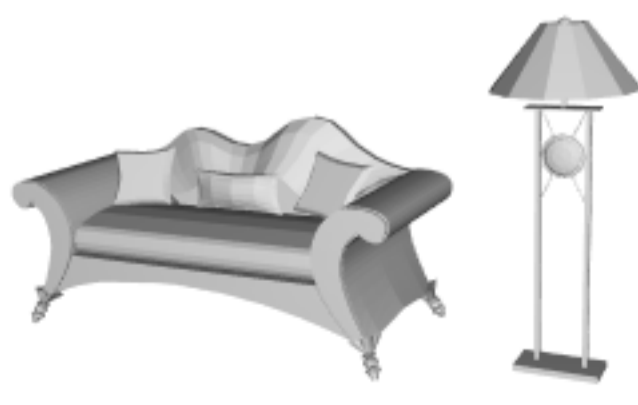

0.25



0.166667

Task 43 of 50 Score = 1.73398

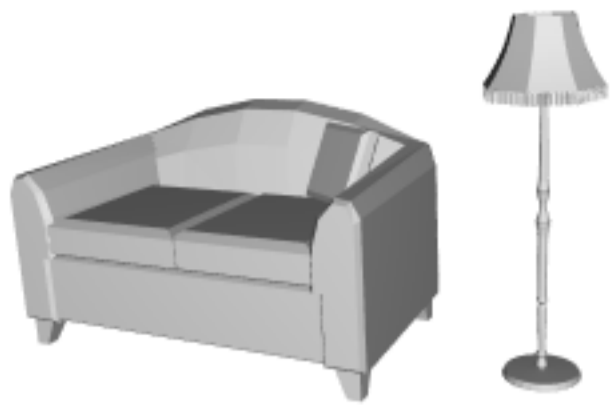

0.454545

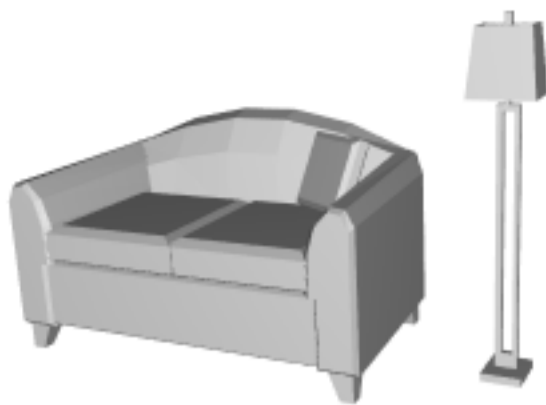

0.454545

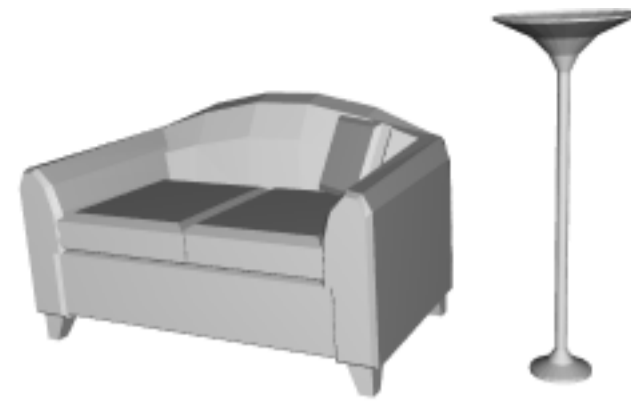

0.363636



0.363636

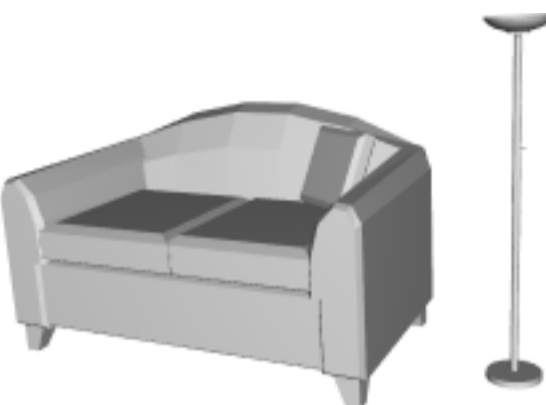

0.181818

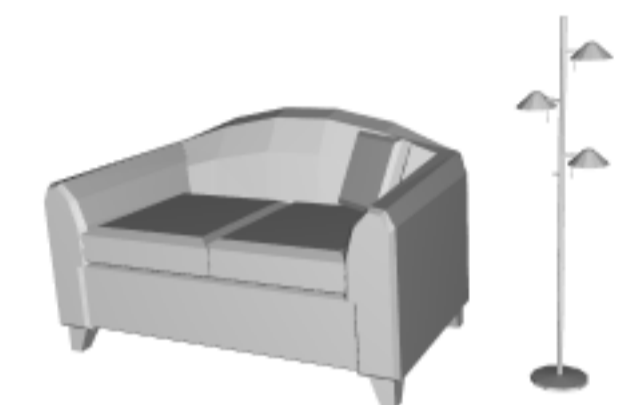

0.181818

Task 44 of 50 Score = 1.73398



0.454545



0.454545



0.363636



0.272727



0.272727



0.181818

Task 45 of 50 Score = 1.73398





0.454545

0.454545

0.363636

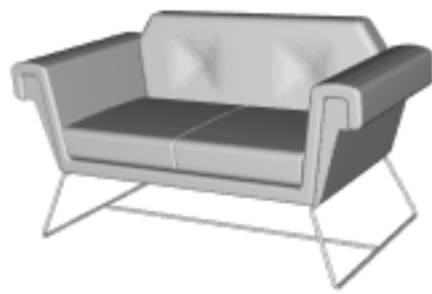
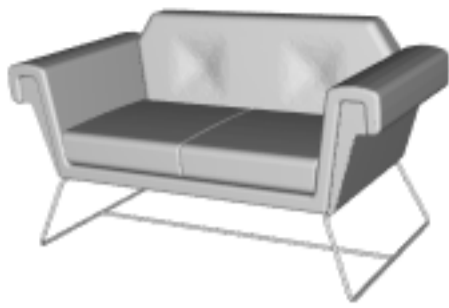

0.272727

0.272727

0.181818

Task 46 of 50 Score = 1.73398

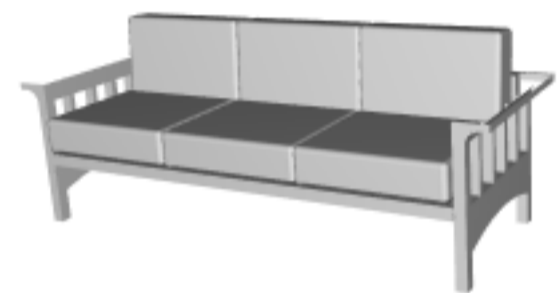
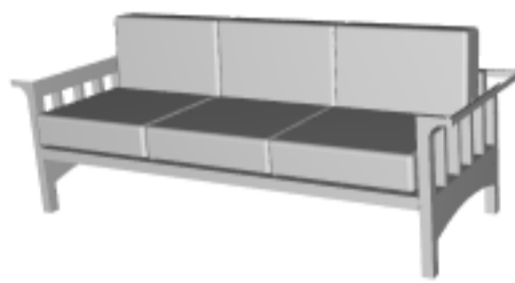
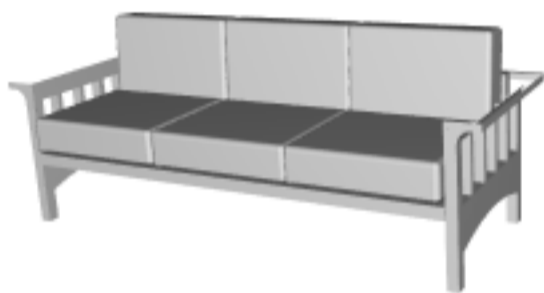

0.454545

0.454545

0.363636

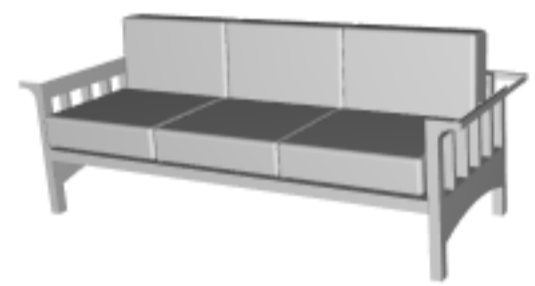
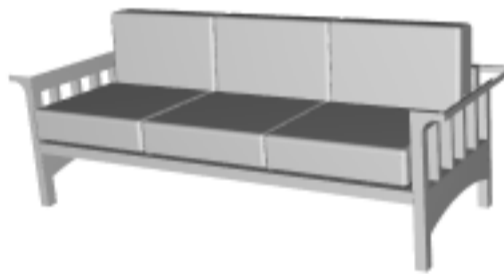
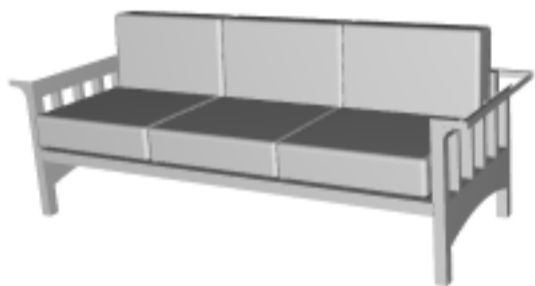

0.363636

0.181818

0.181818

Task 47 of 50 Score = 1.73398

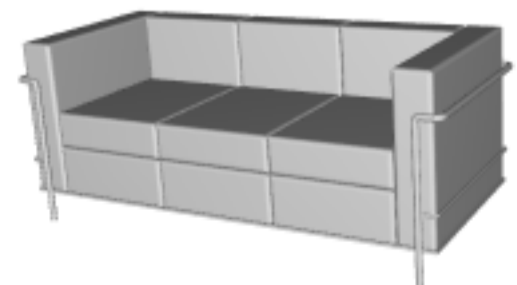
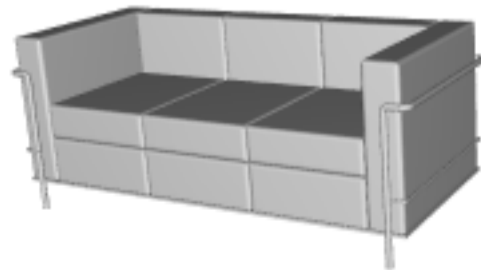
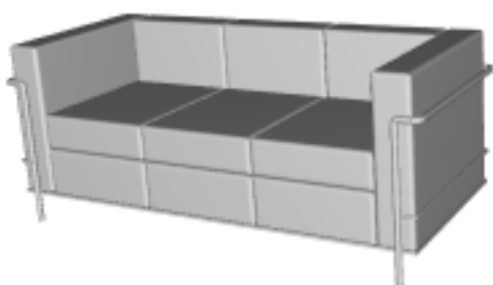

0.454545

0.454545

0.363636



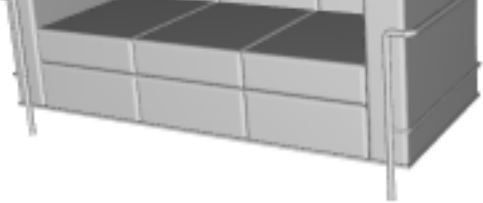

0.272727

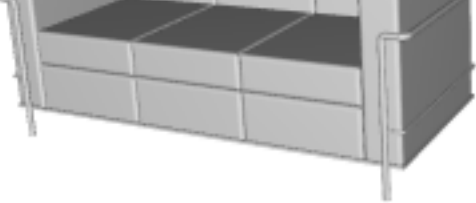

0.272727

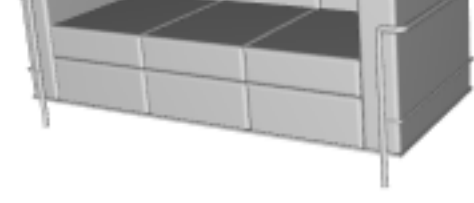

0.181818

Task 48 of 50 Score = 1.73398



0.454545



0.454545



0.363636



0.272727



0.272727



0.181818

Task 49 of 50 Score = 2.21088



0.416667



0.416667



0.416667



0.333333



0.25



0.166667

Task 50 of 50 Score = 2.21088



0.416667



0.416667



0.333333



0.333333



0.25



0.25

