

Task 1

Initially fixed object: Chair

Our suggestions

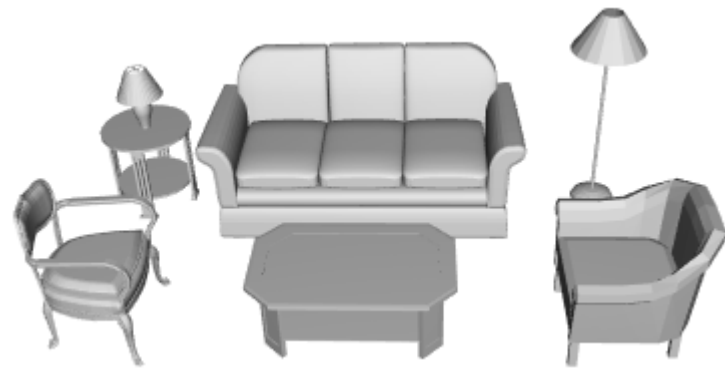

Random suggestions

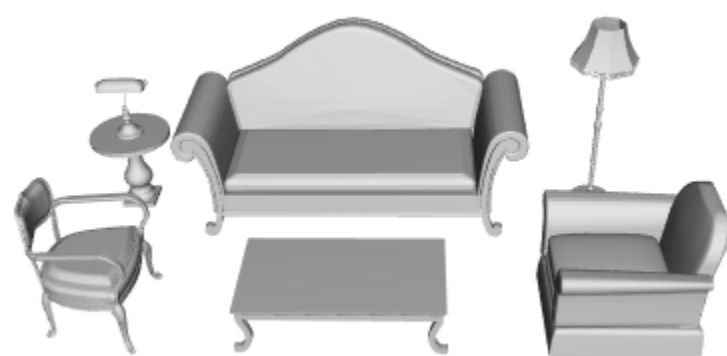
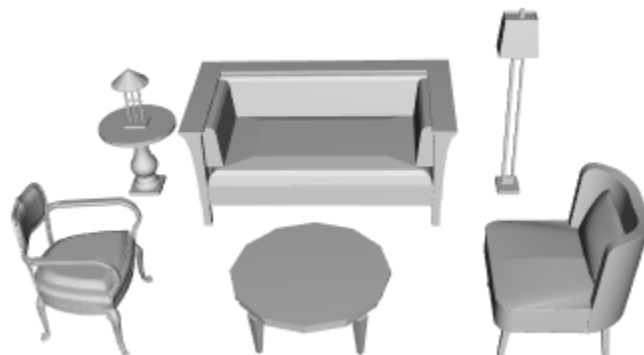
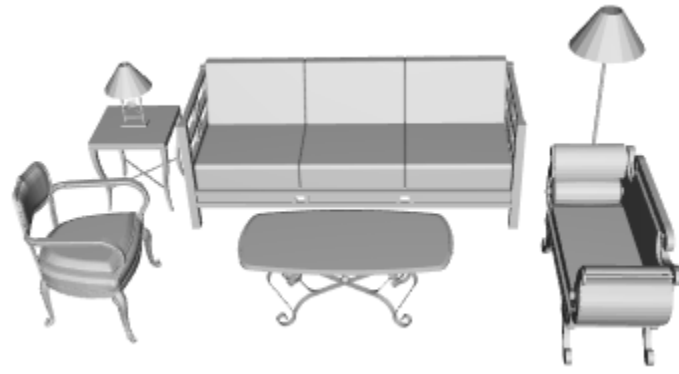

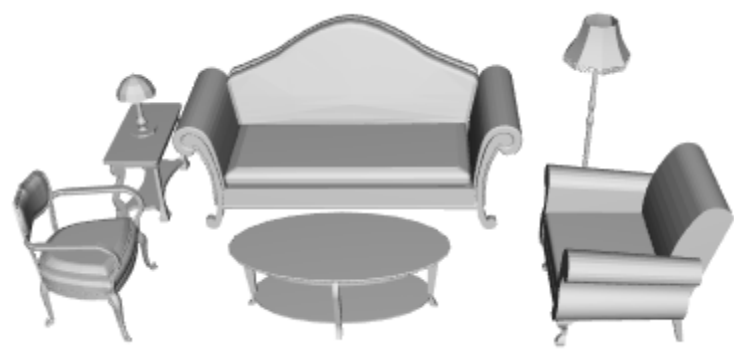
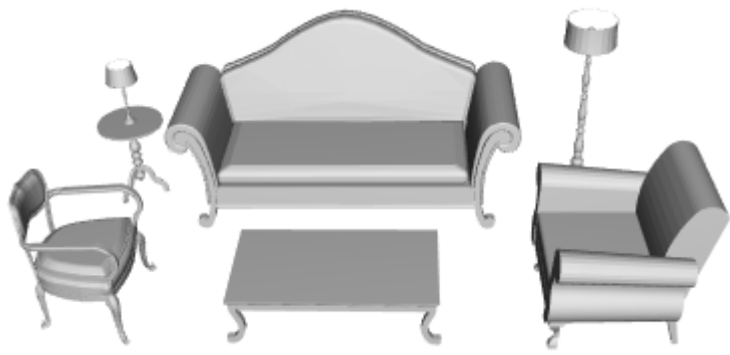

Task 2

Initially fixed object: Chair

Our suggestions

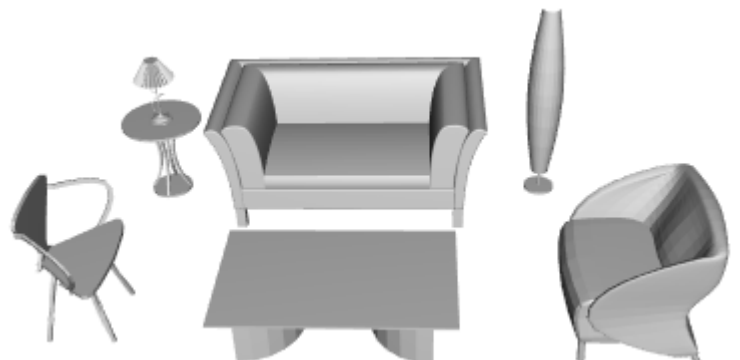
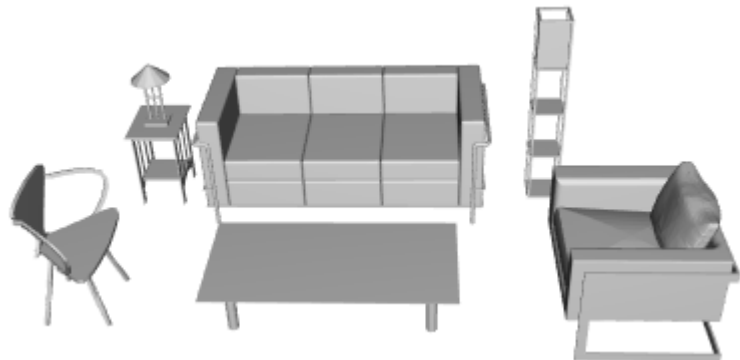
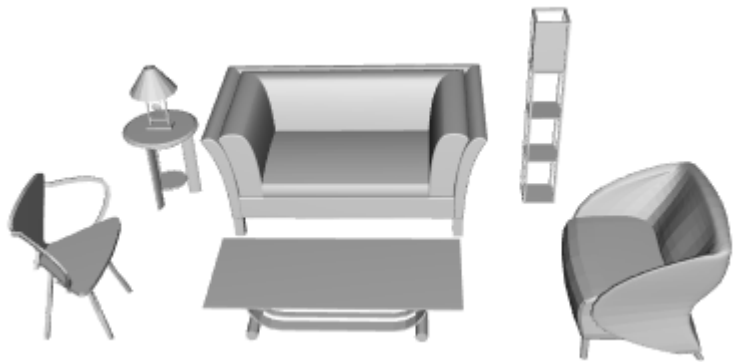

Random suggestions

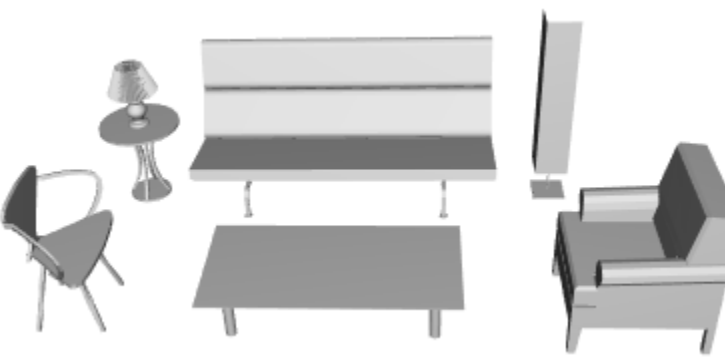
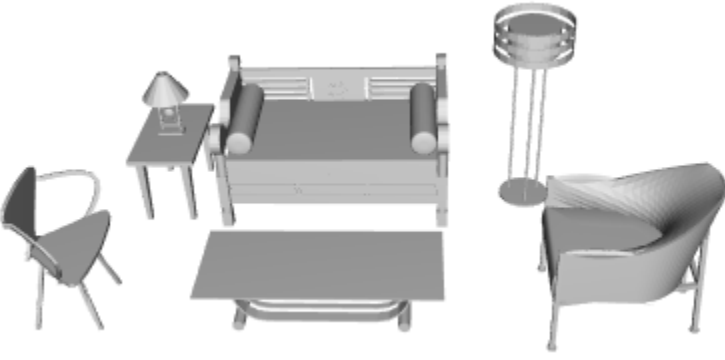
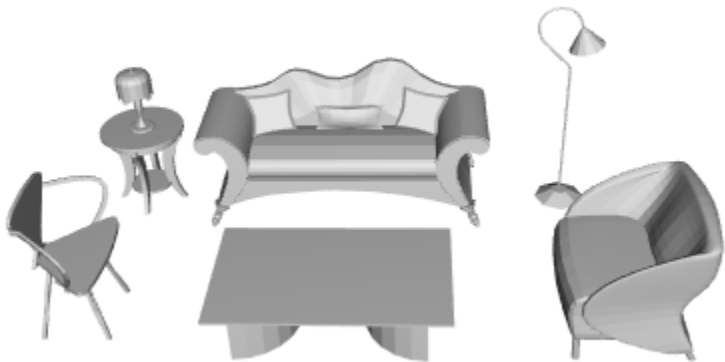

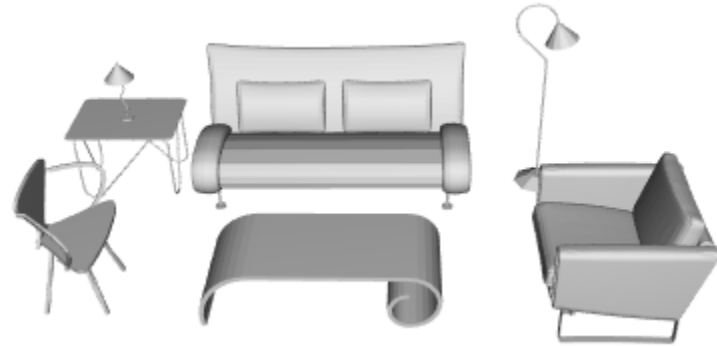
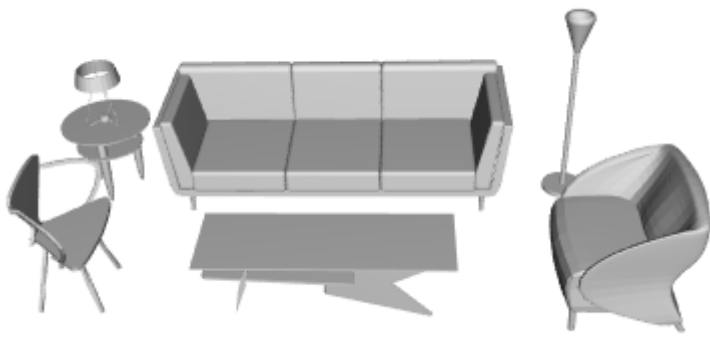

Task 3

Initially fixed object: ClubChair
Our suggestions

Random suggestions

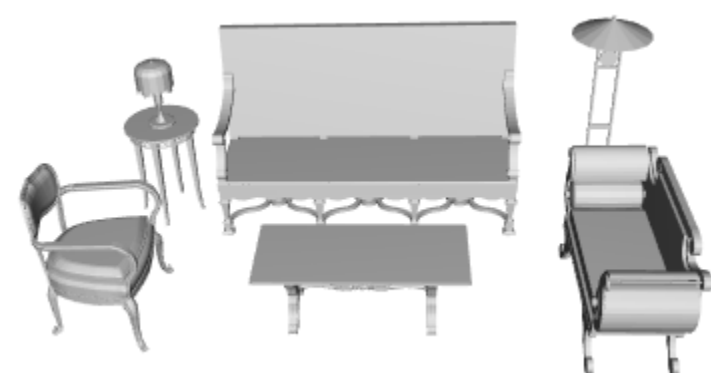
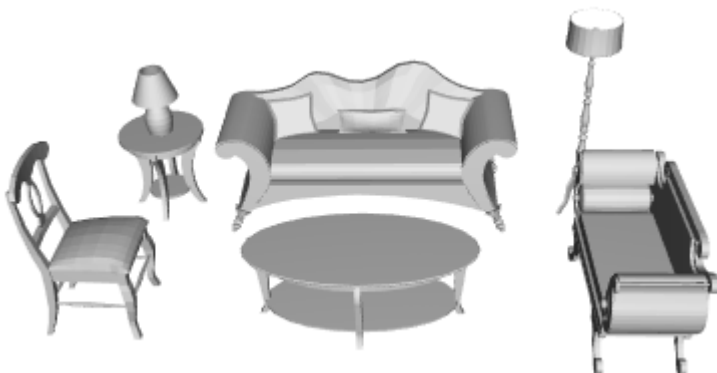
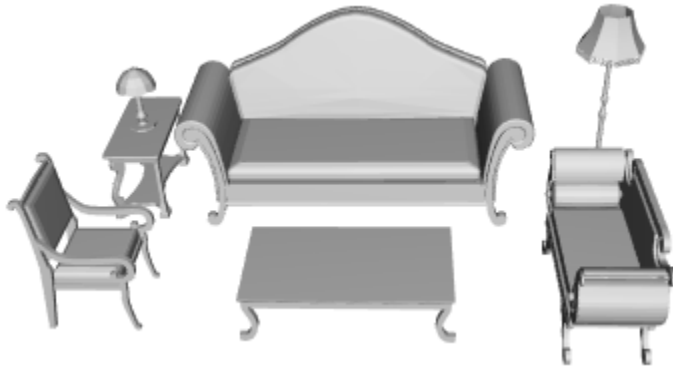
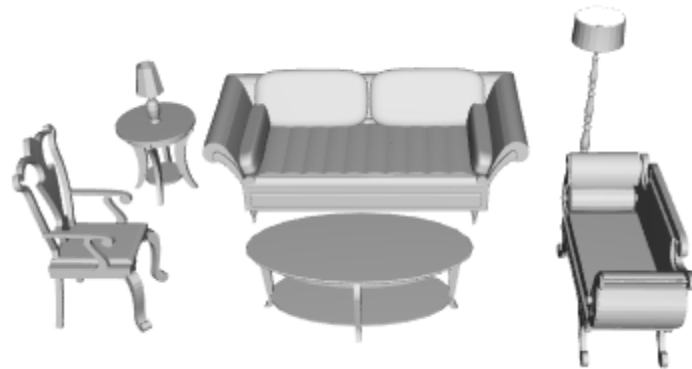

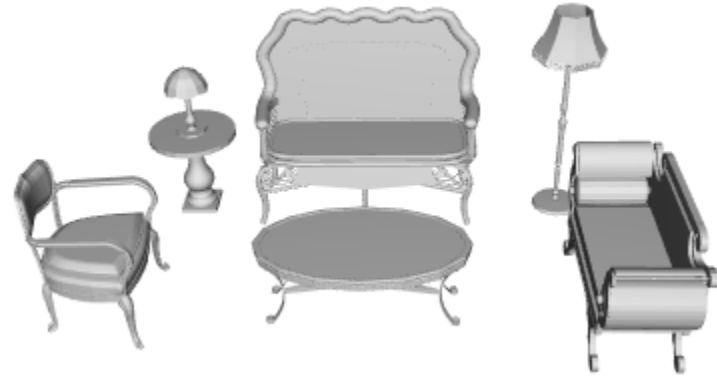
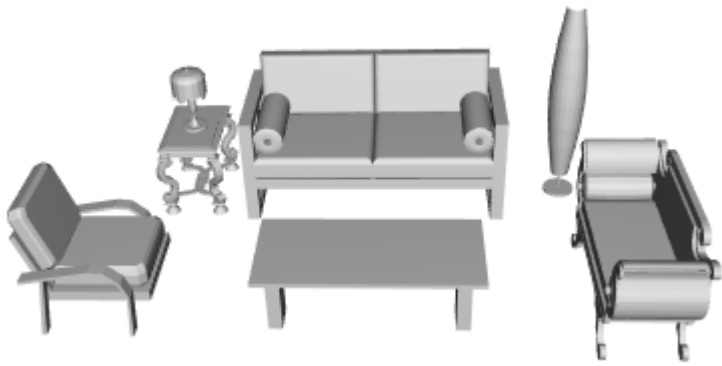
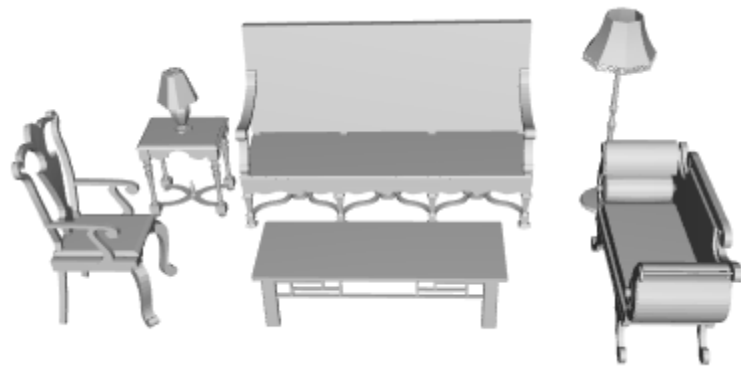
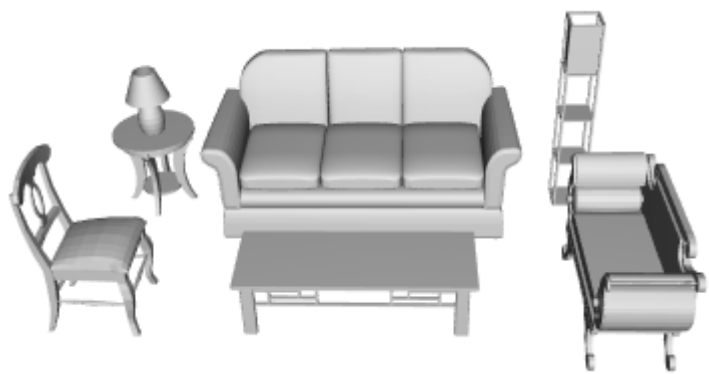

Task 4

Initially fixed object: ClubChair
Our suggestions

Random suggestions

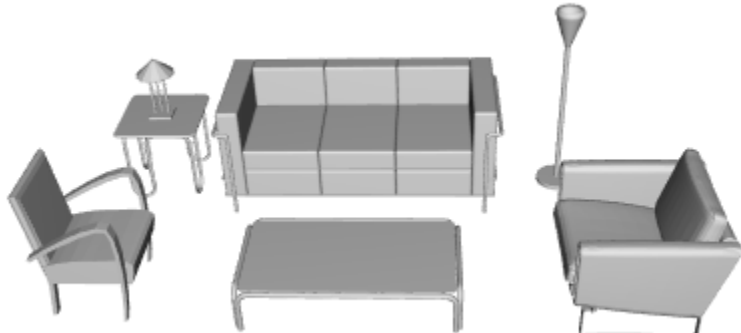
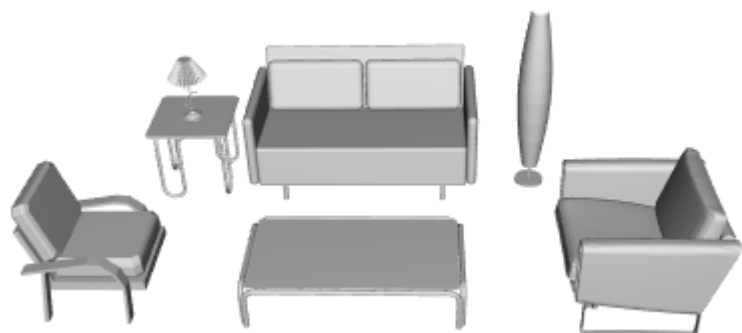

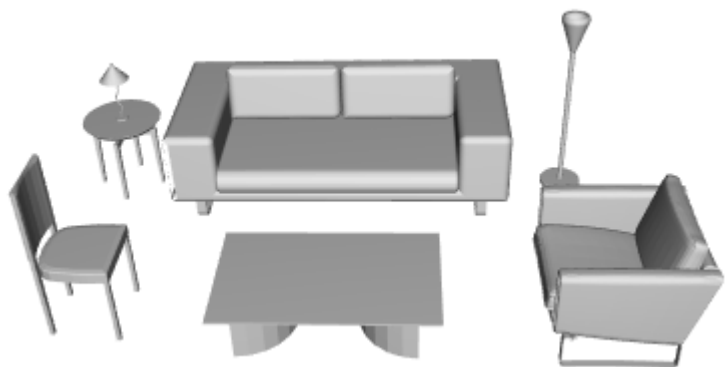
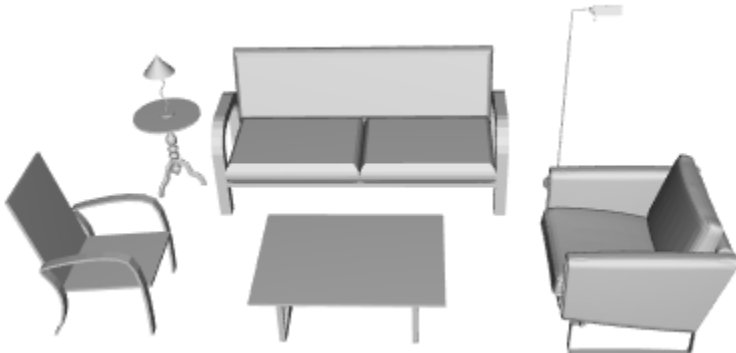

Task 5

Initially fixed object: Couch

Our suggestions

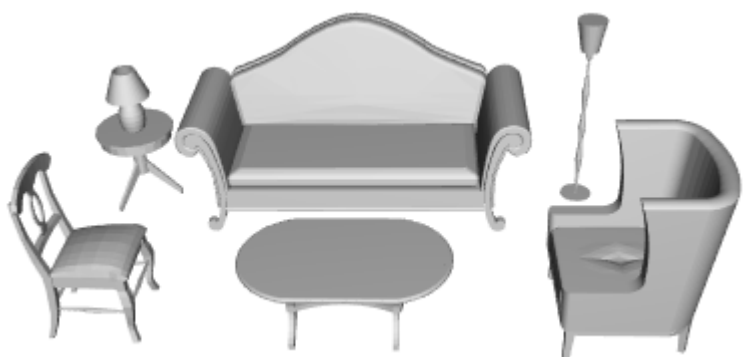

Random suggestions



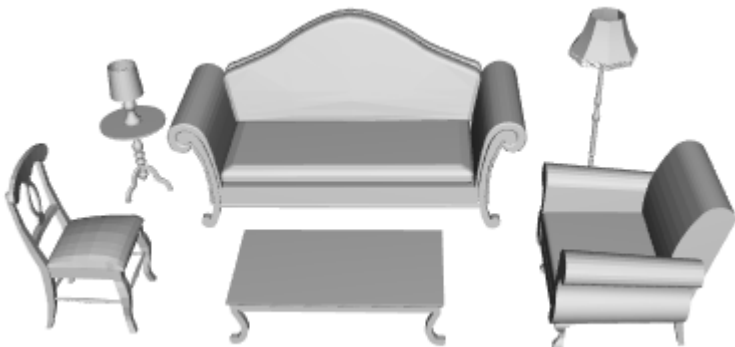
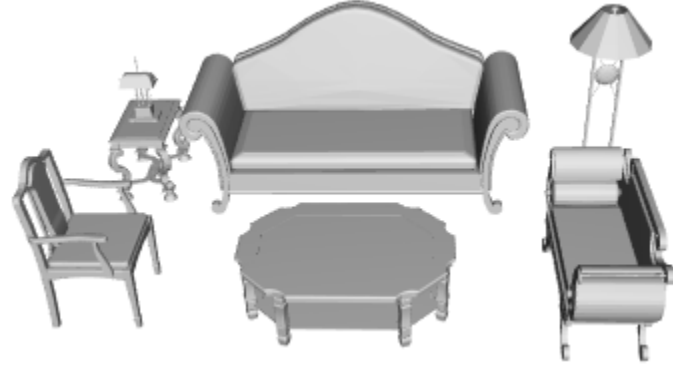
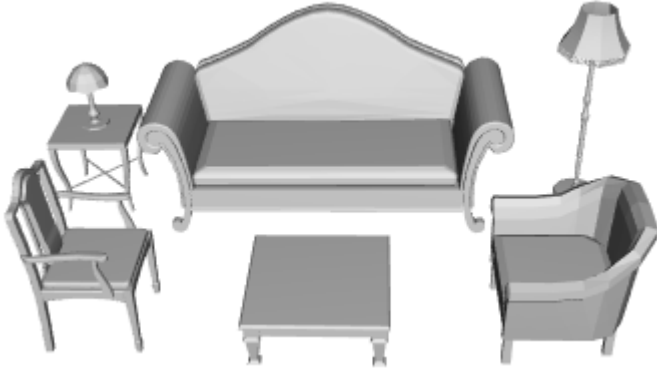
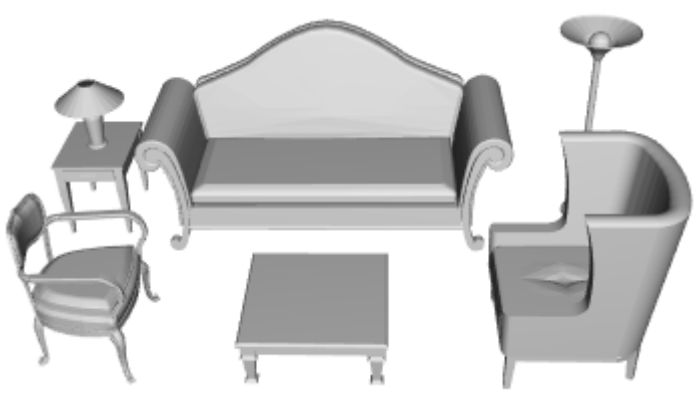

Task 6

Initially fixed object: Couch
Our suggestions

Random suggestions

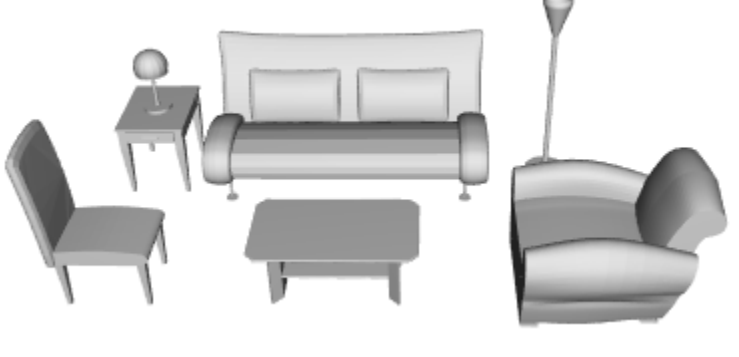
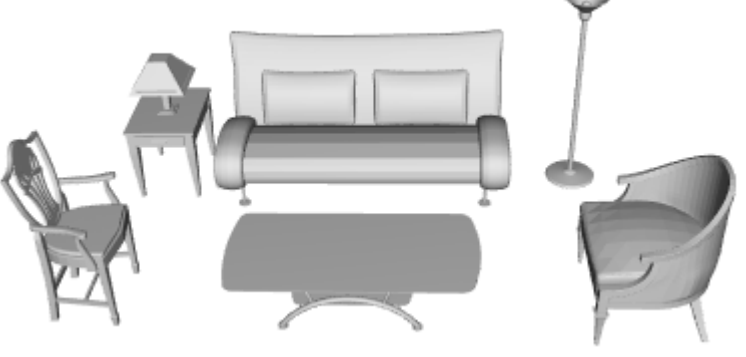
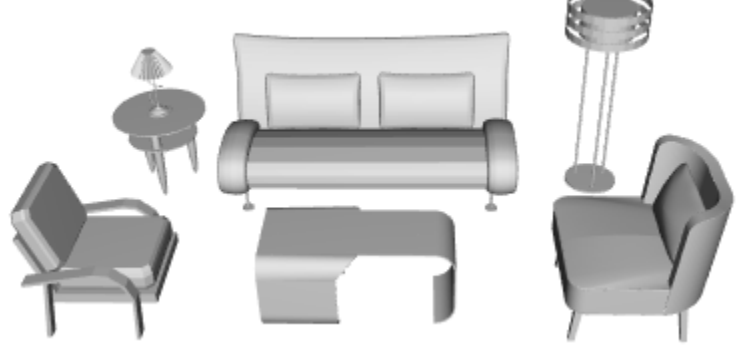
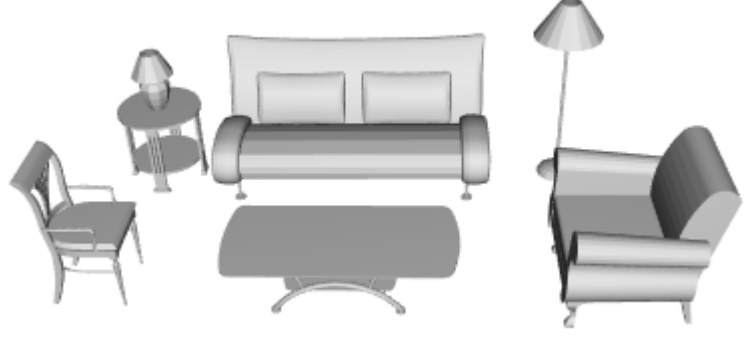
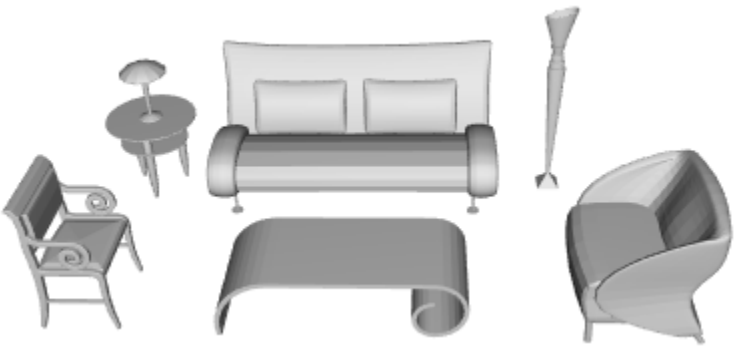
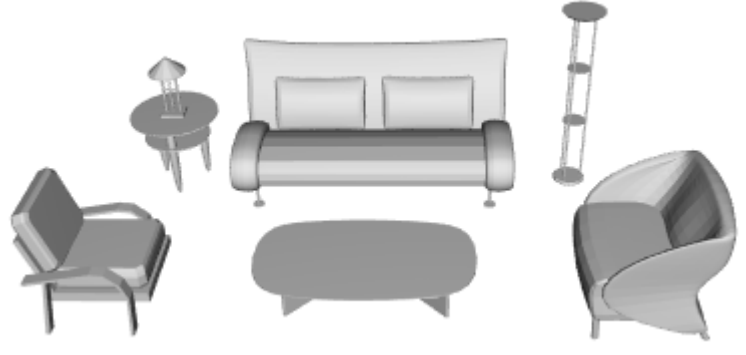
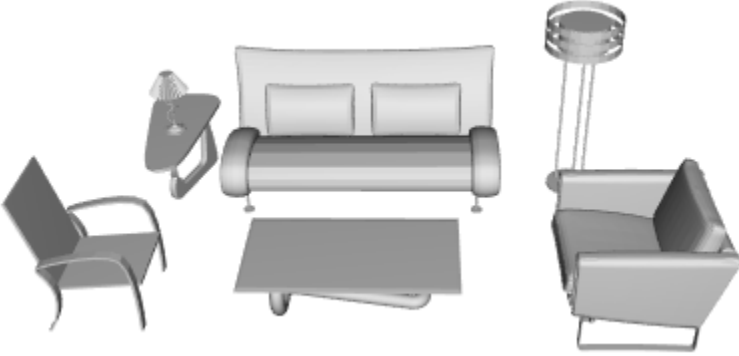
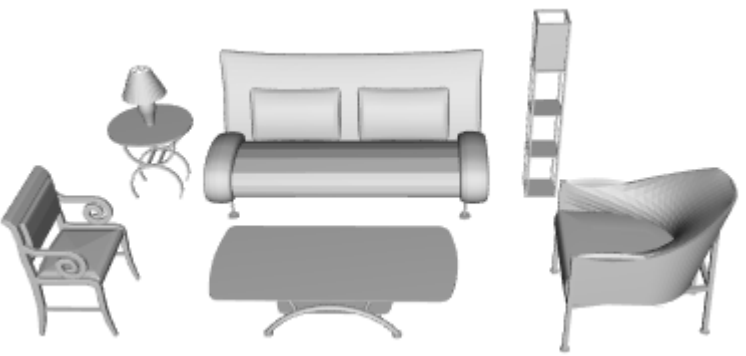
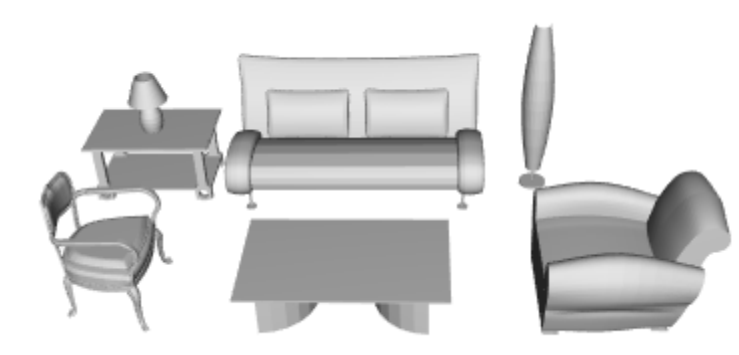
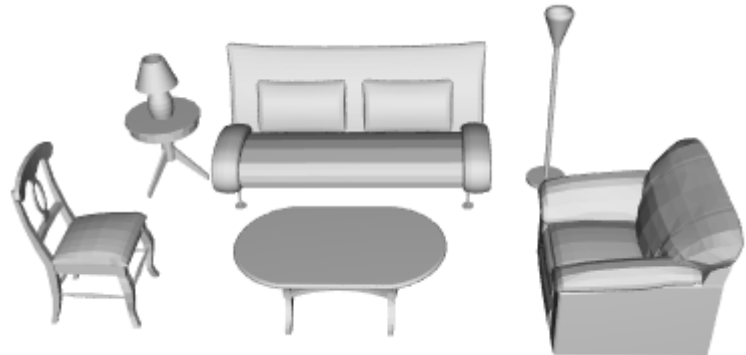

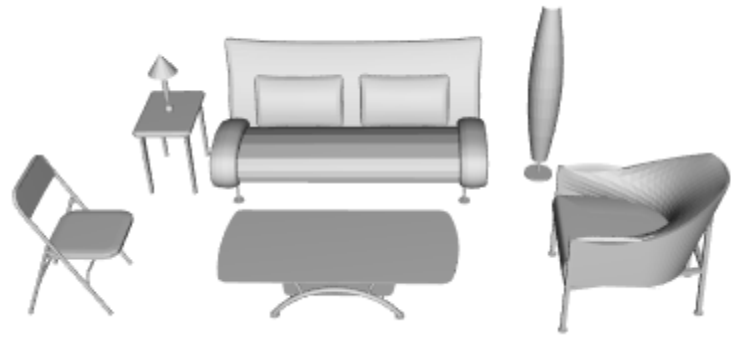
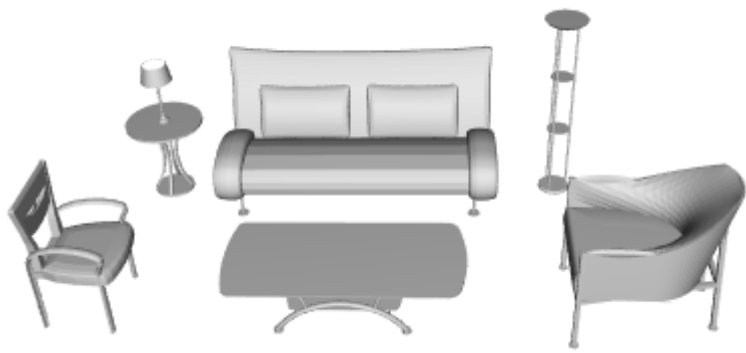

Task 7

Initially fixed object: CoffeeTable

Our suggestions

Random suggestions

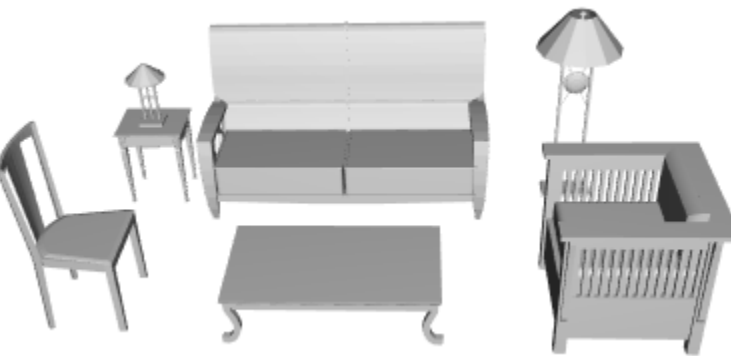
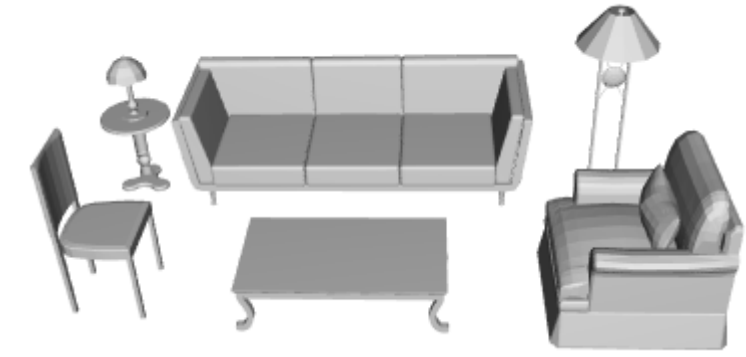



Task 8

Initially fixed object: CoffeeTable

Our suggestions

Random suggestions

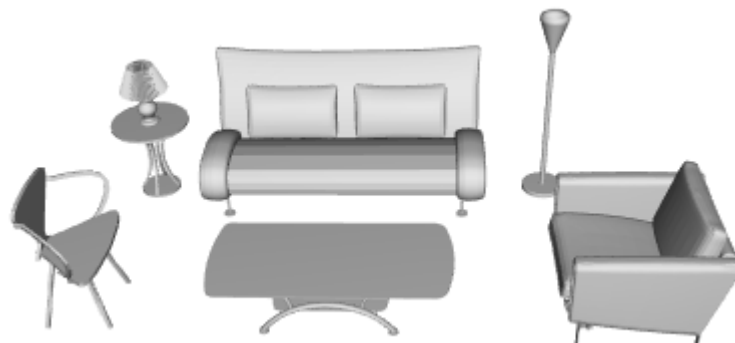

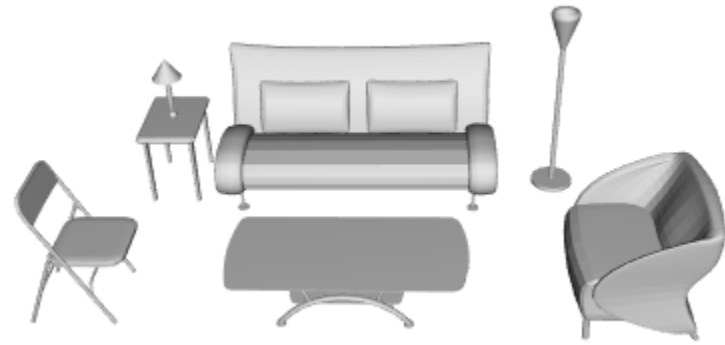
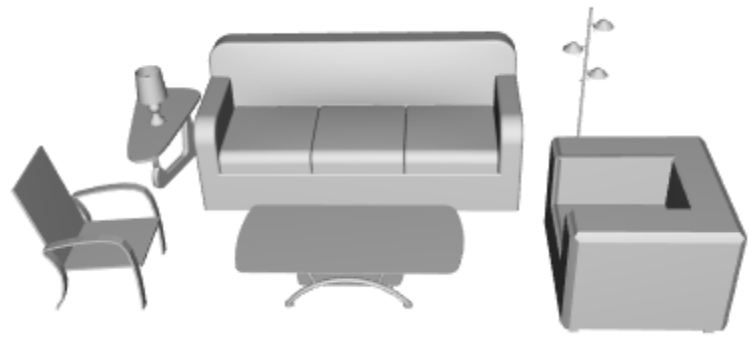

Task 9

Initially fixed object: EndTable
Our suggestions

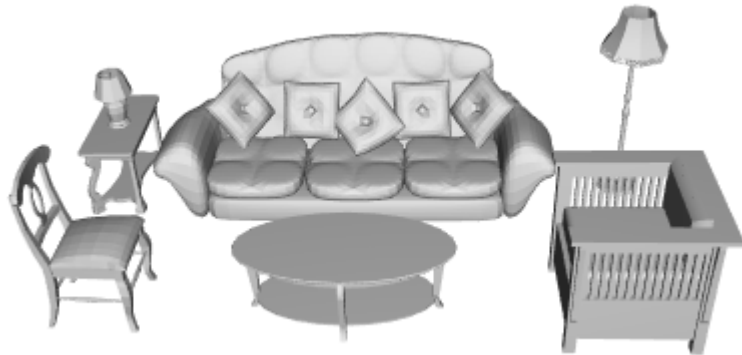

Random suggestions

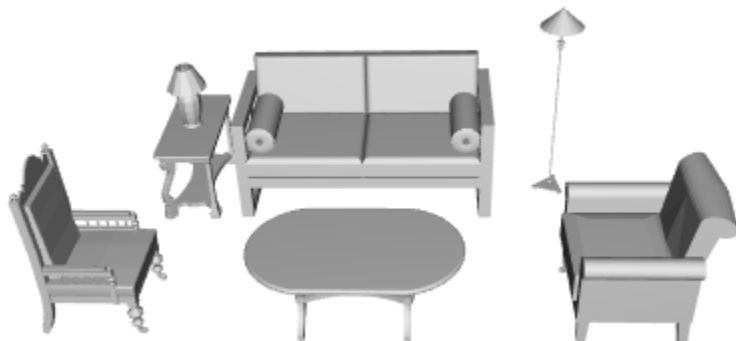
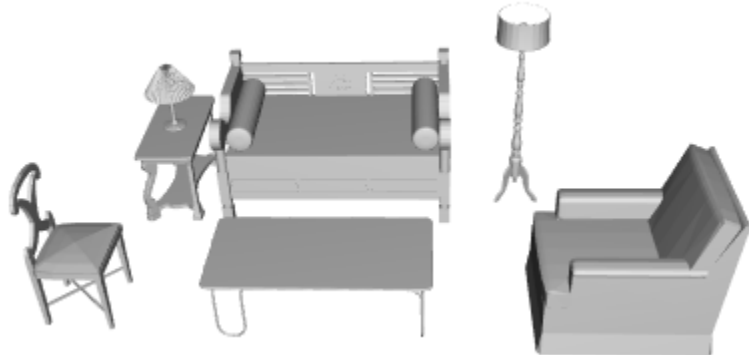

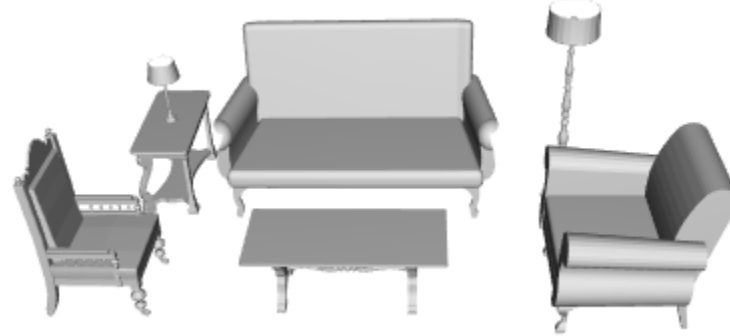
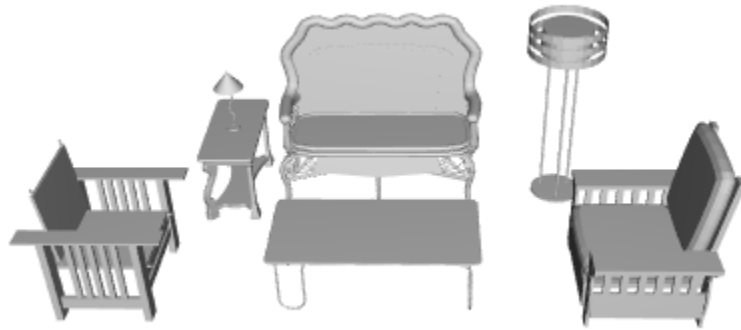
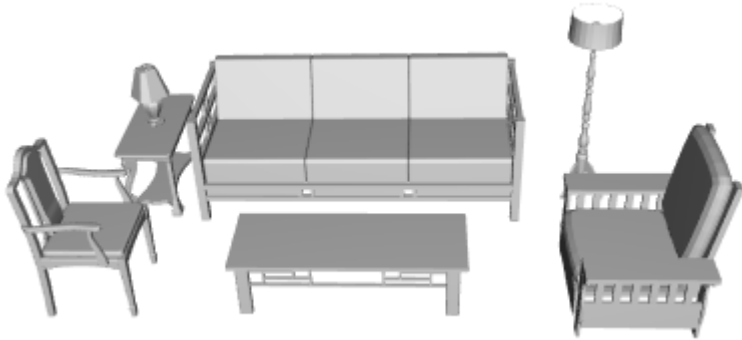

Task 10

Initially fixed object: EndTable

Our suggestions



Random suggestions



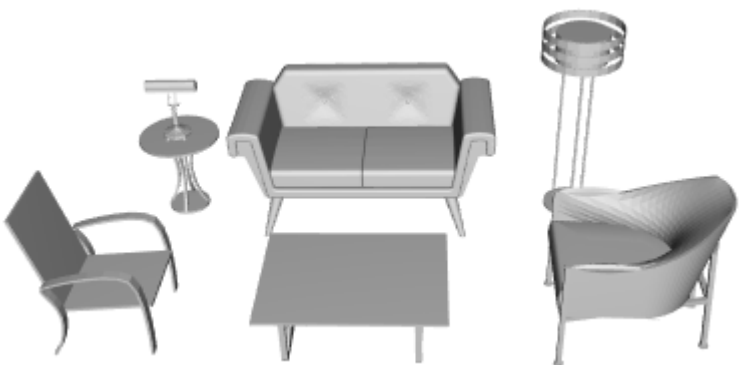
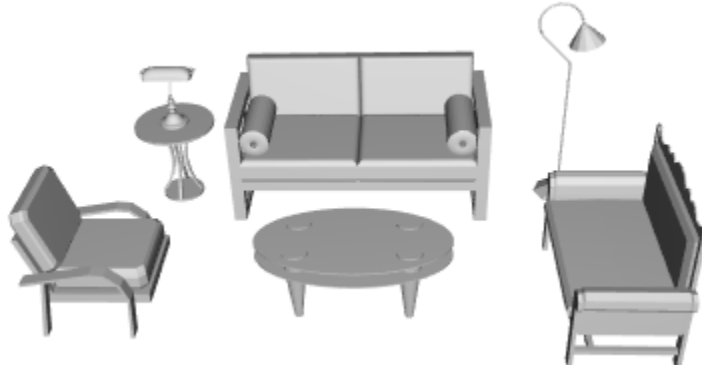
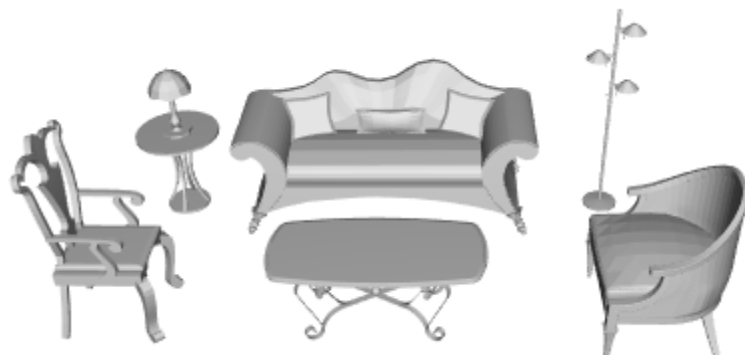
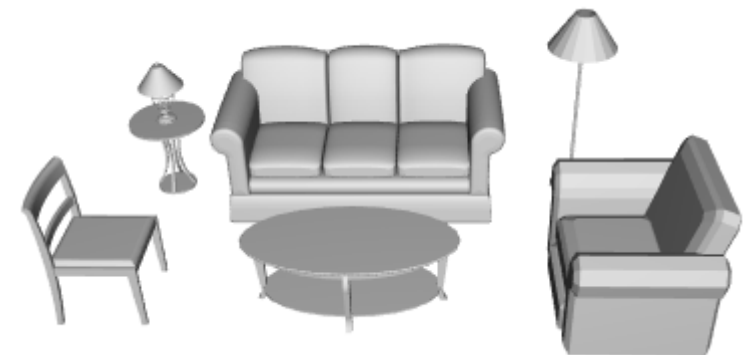

Task 11

Initially fixed object: FloorLamp
Our suggestions

Random suggestions

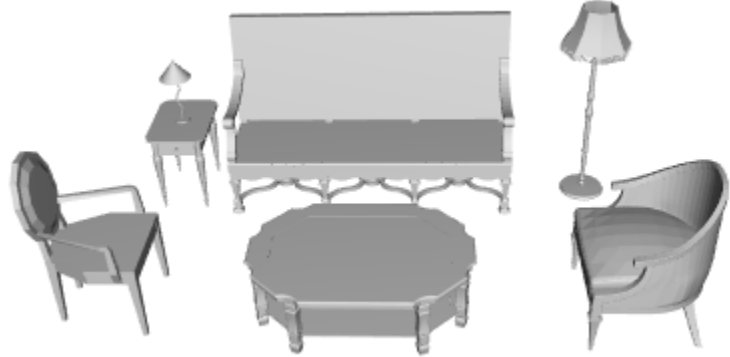
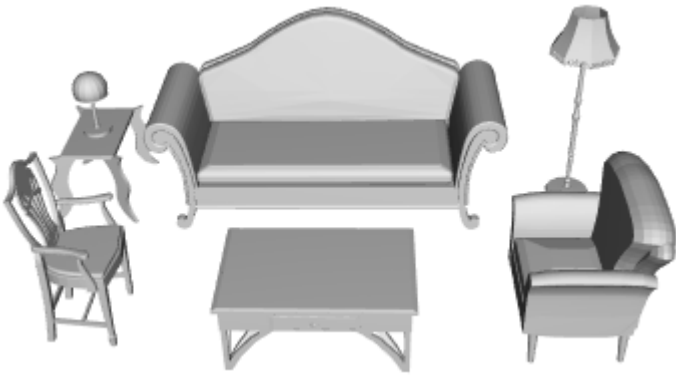
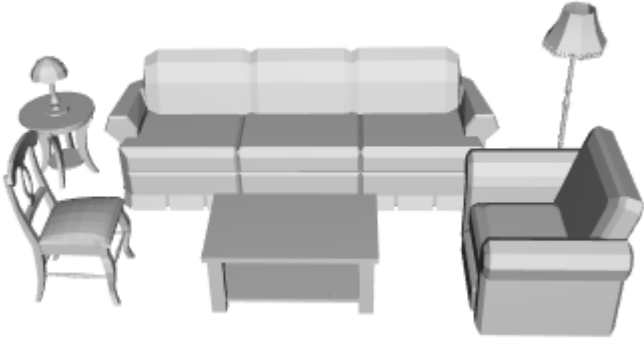

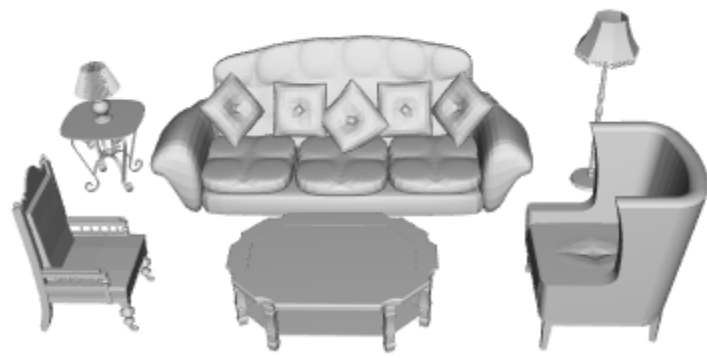
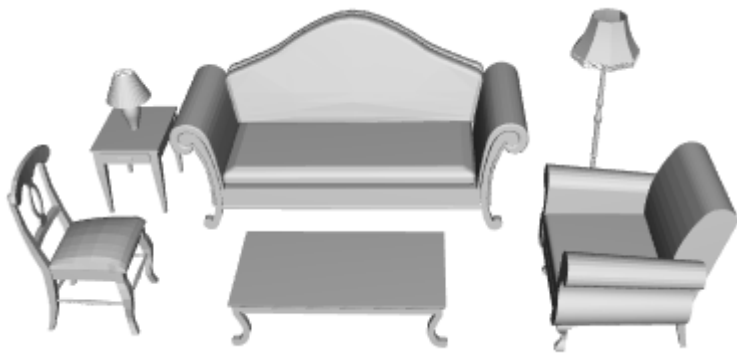

Task 12

Initially fixed object: FloorLamp

Our suggestions



Random suggestions

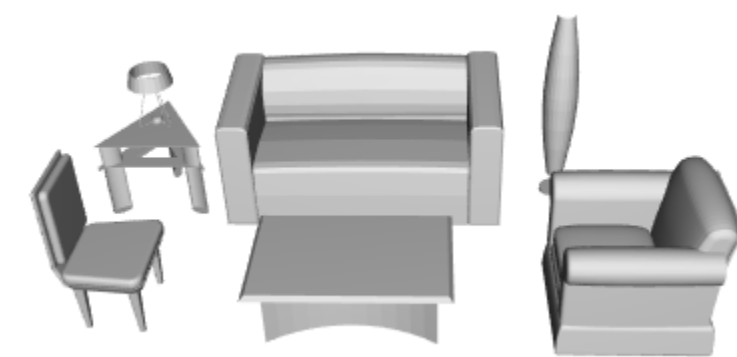
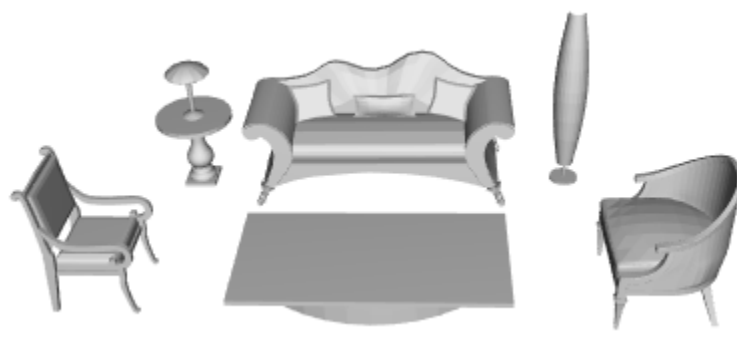
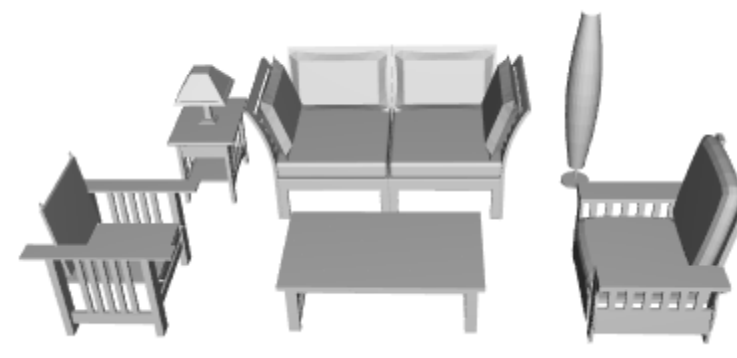

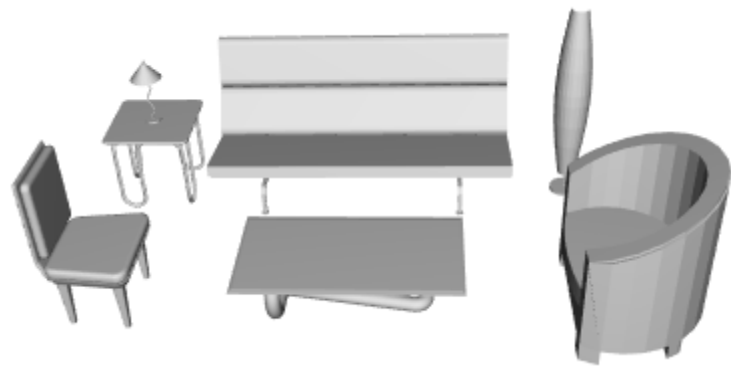

Task 13

Initially fixed object: TableLamp

Our suggestions

Random suggestions

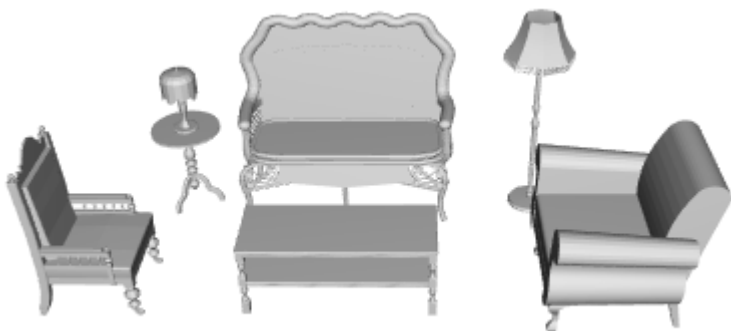

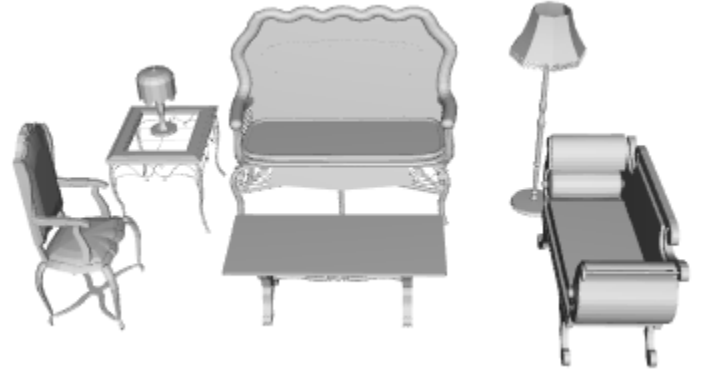
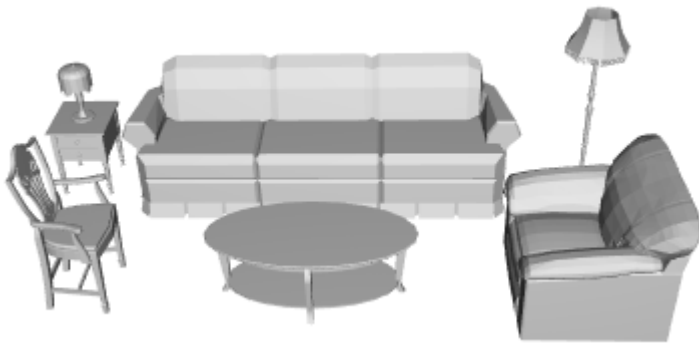

Task 14

Initially fixed object: TableLamp
Our suggestions

Random suggestions

