

Task 1 of 50 Score = 0.00127578

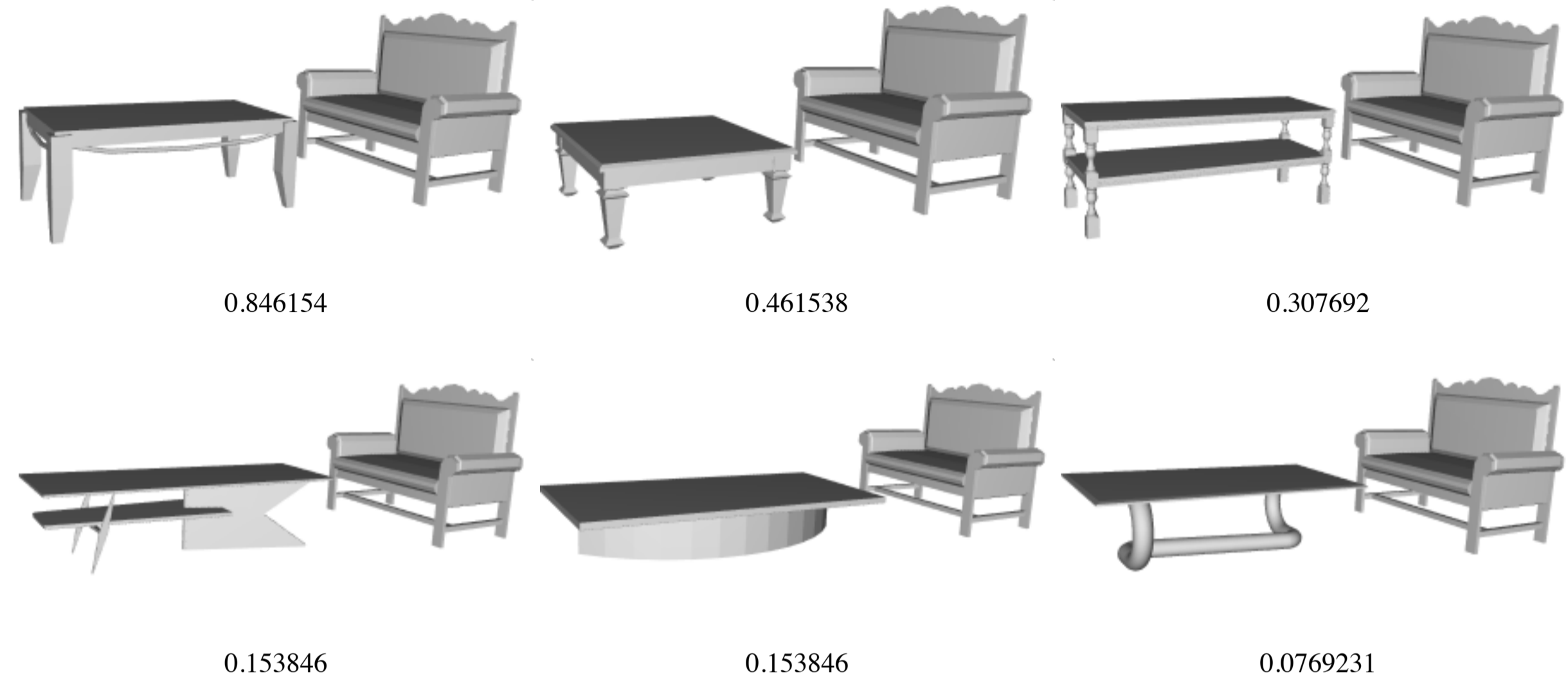

Task 2 of 50 Score = 0.00988633

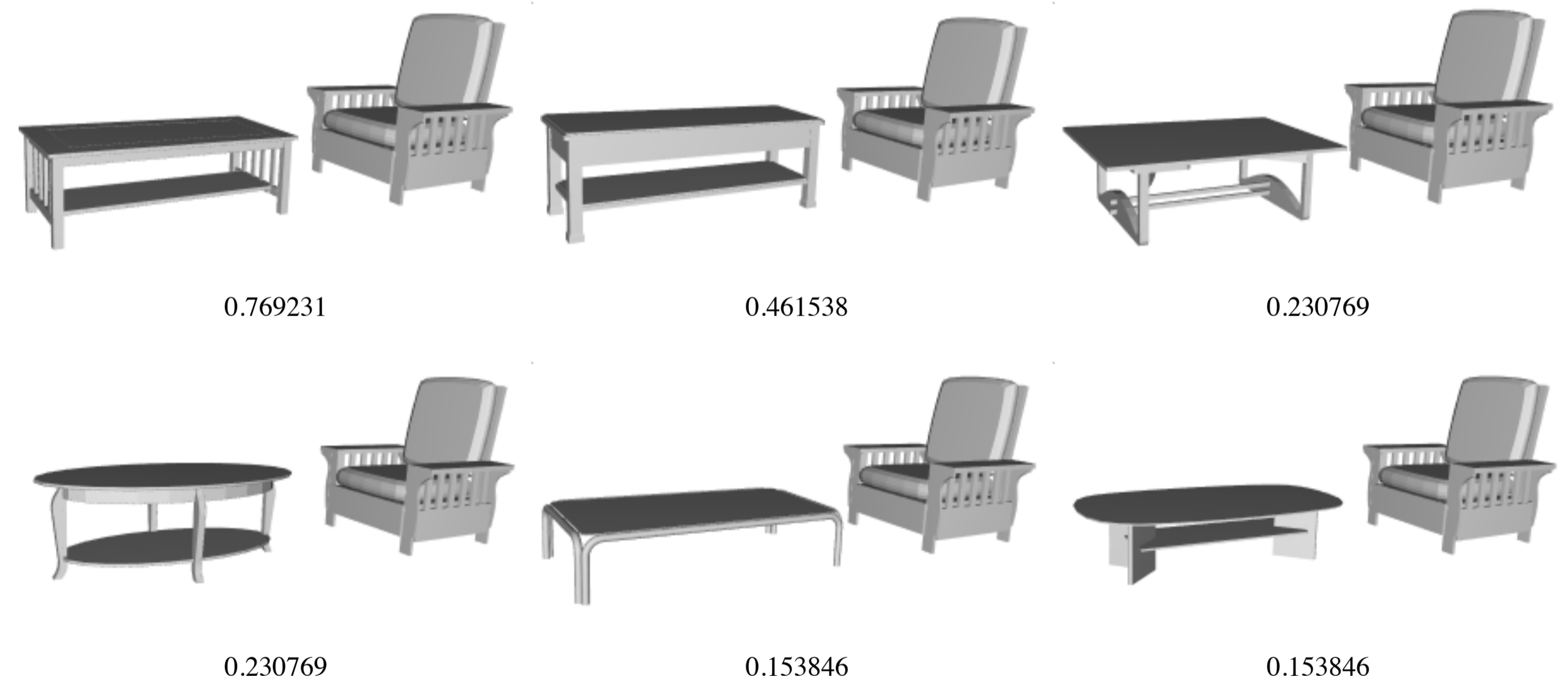

Task 3 of 50 Score = 0.00988633





0.769231



0.461538



0.384615



0.307692



0.0769231



0

Task 4 of 50 Score = 0.0204237



0.8



0.5

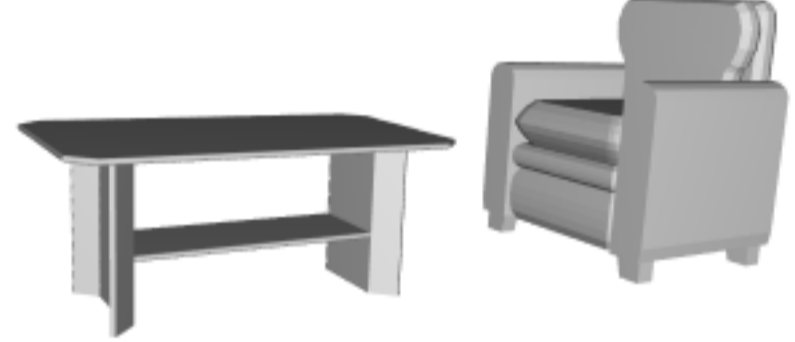

0.5



0.2

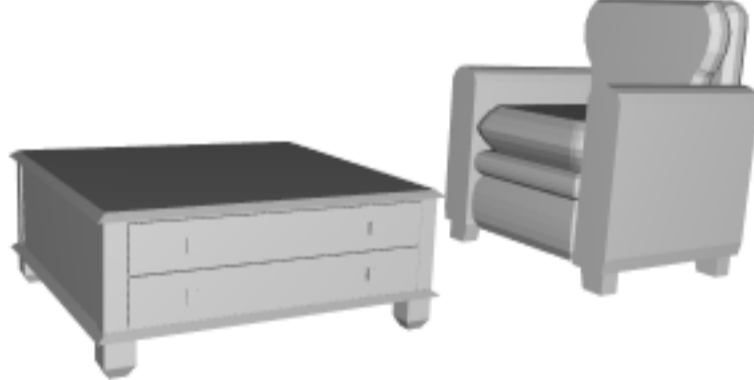

0



0

Task 5 of 50 Score = 0.0529391

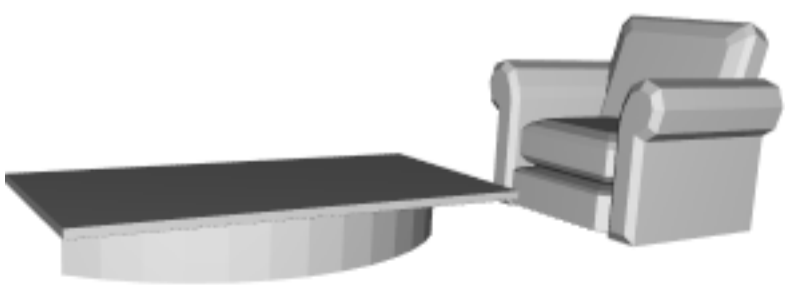

0.692308

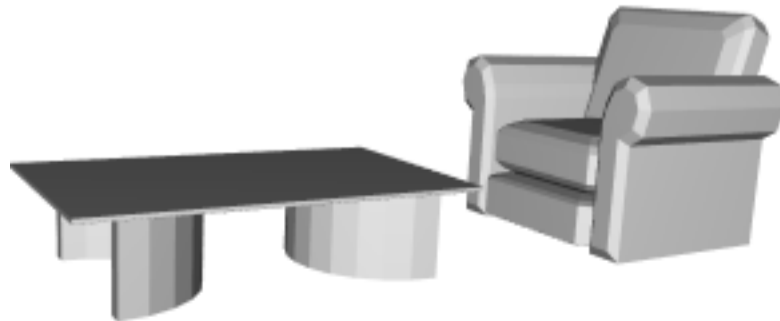

0.615385

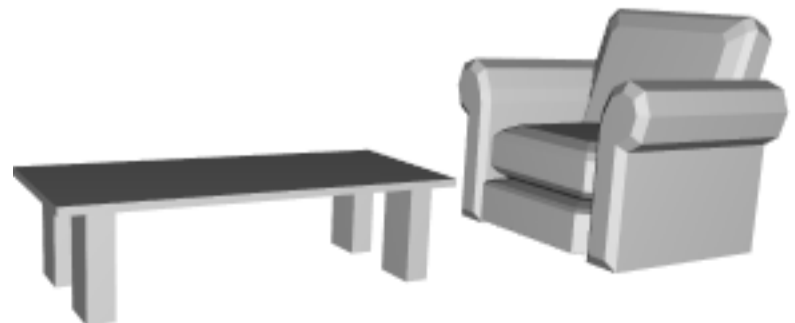

0.307692





0.153846



0.153846



0.0769231

Task 6 of 50 Score = 0.0529391



0.692308



0.461538

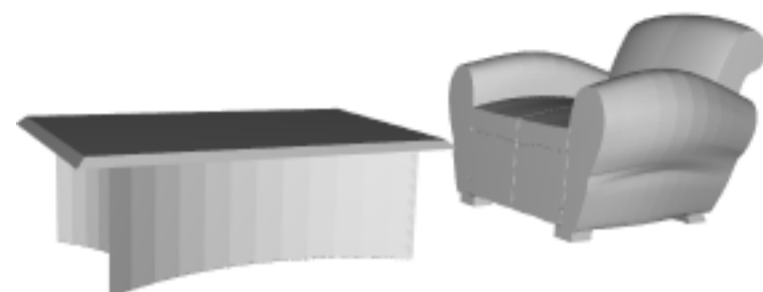

0.384615

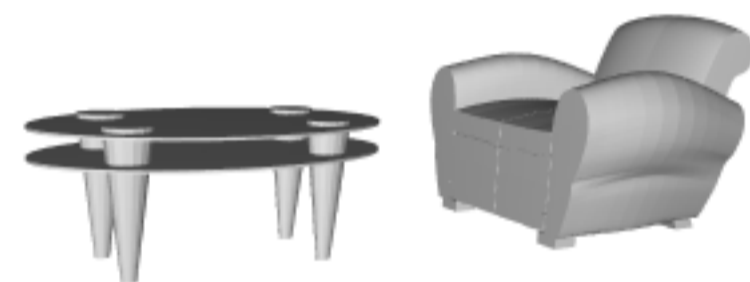

0.153846



0.153846



0.153846

Task 7 of 50 Score = 0.0529391

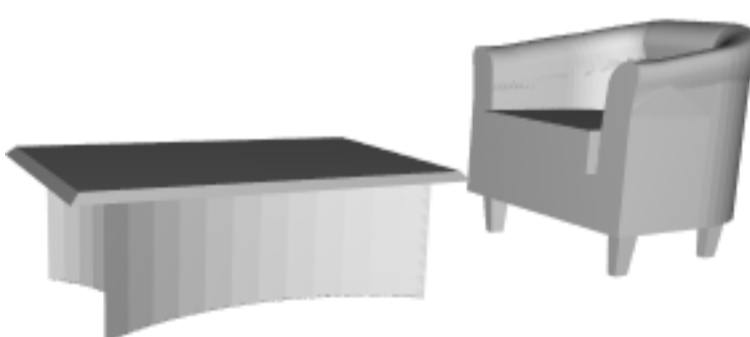

0.692308

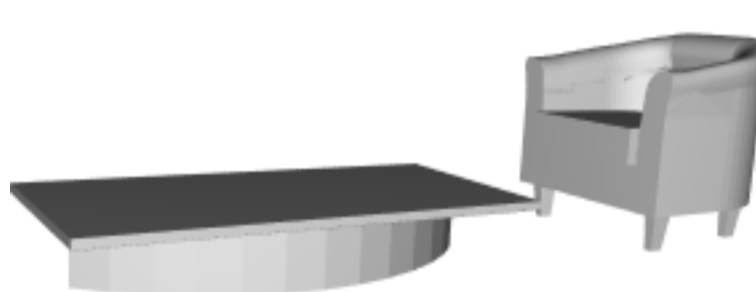

0.461538



0.307692



0.307692



0.230769

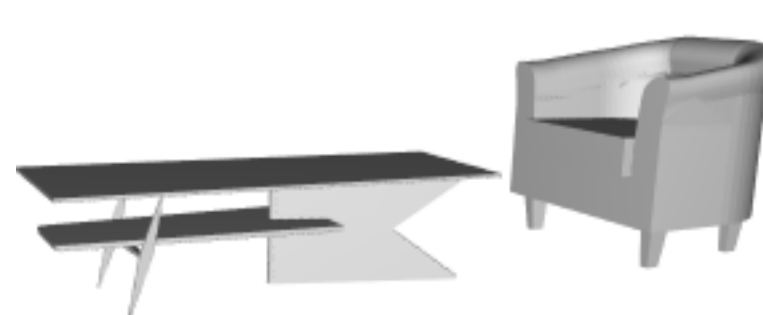

0

Task 8 of 50 Score = 0.0529391

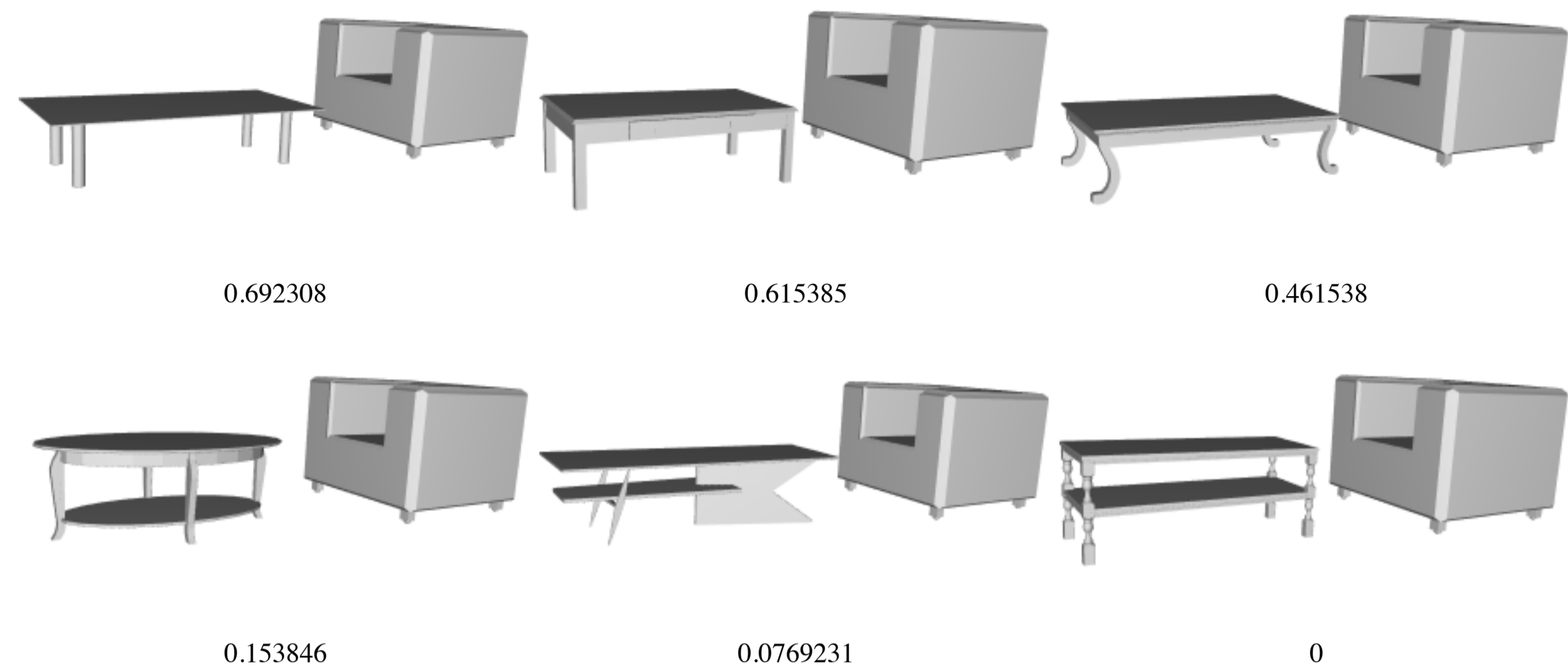

Task 9 of 50 Score = 0.11797

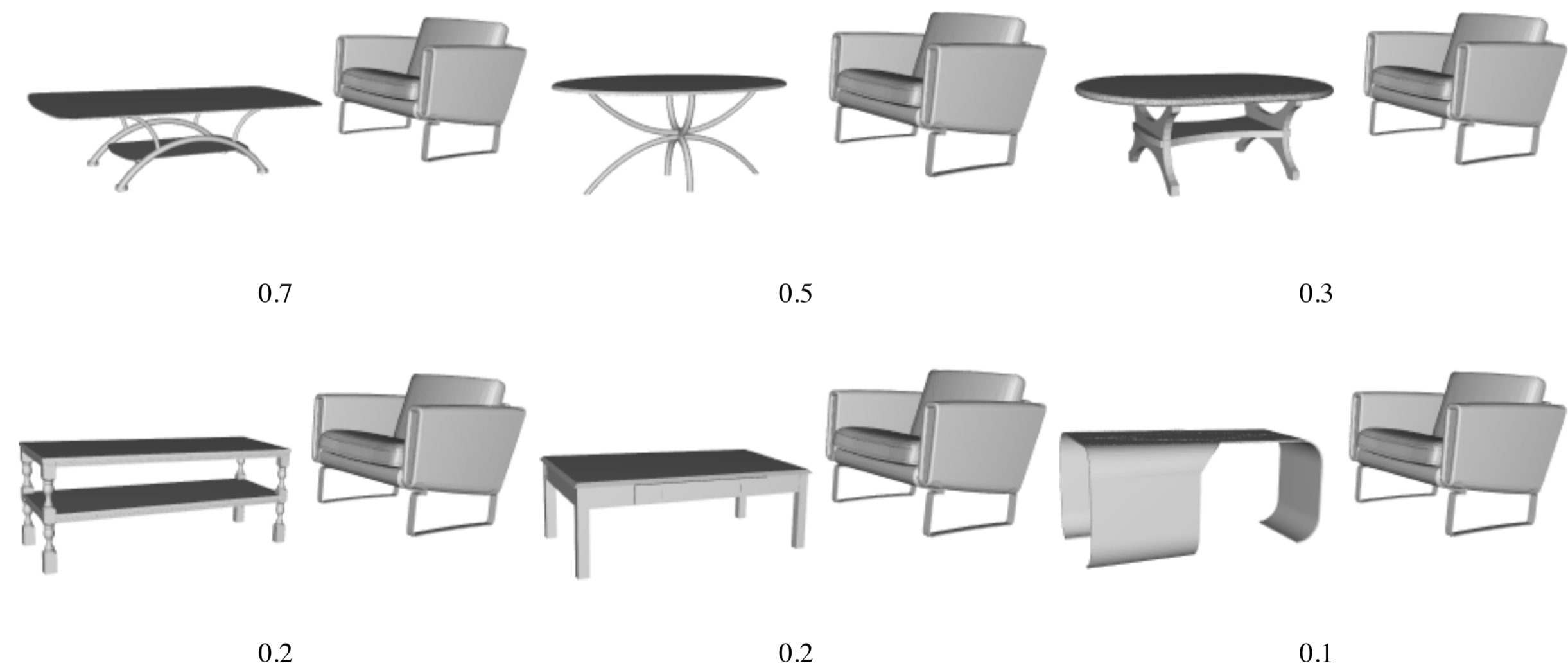

Task 10 of 50 Score = 0.11797



0.7

0.6

0.3

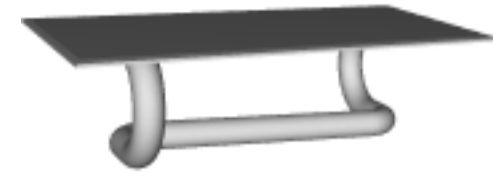
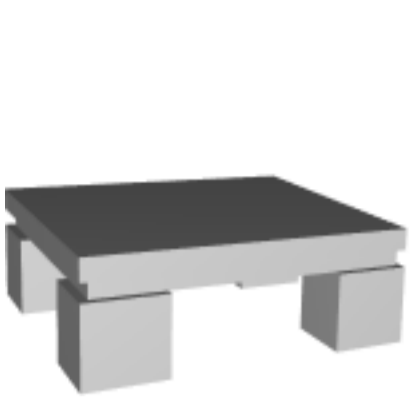

0.2

0.2

0

Task 11 of 50 Score = 0.11797



0.7

0.5

0.3

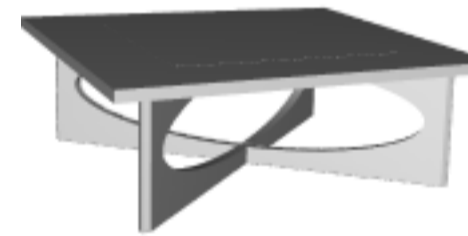

0.2

0.2

0.1

Task 12 of 50 Score = 0.11797



0.7

0.5

0.3

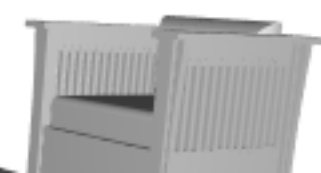
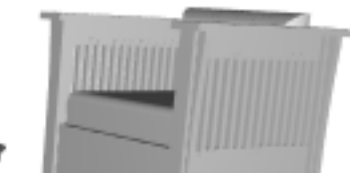
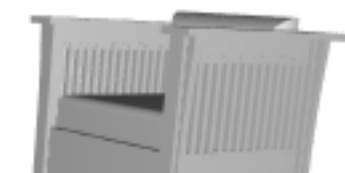

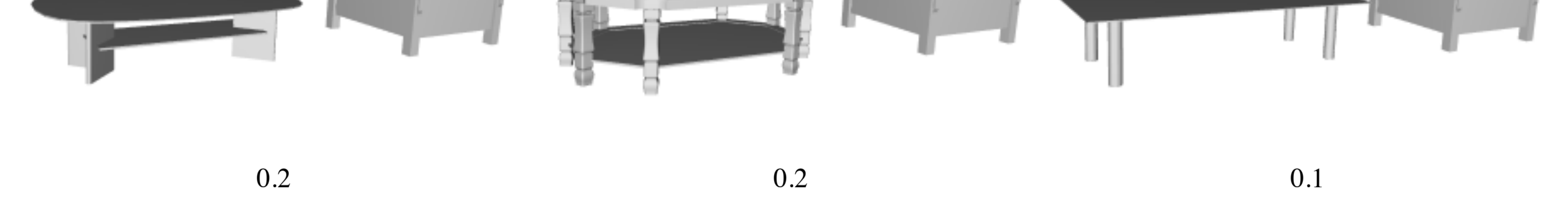

0.2

0.2

0.1

Task 13 of 50 Score = 0.11797

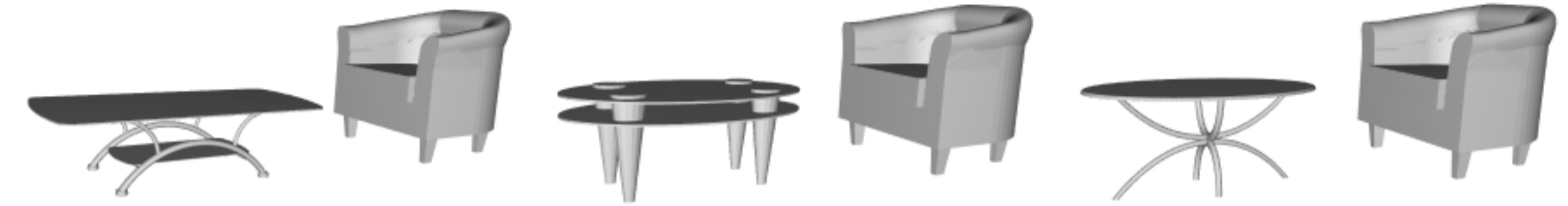

0.7

0.4

0.4



0.3

0.2

0

Task 14 of 50 Score = 0.11797



0.7

0.5

0.3



0.2

0.2

0.1

Task 15 of 50 Score = 0.11797

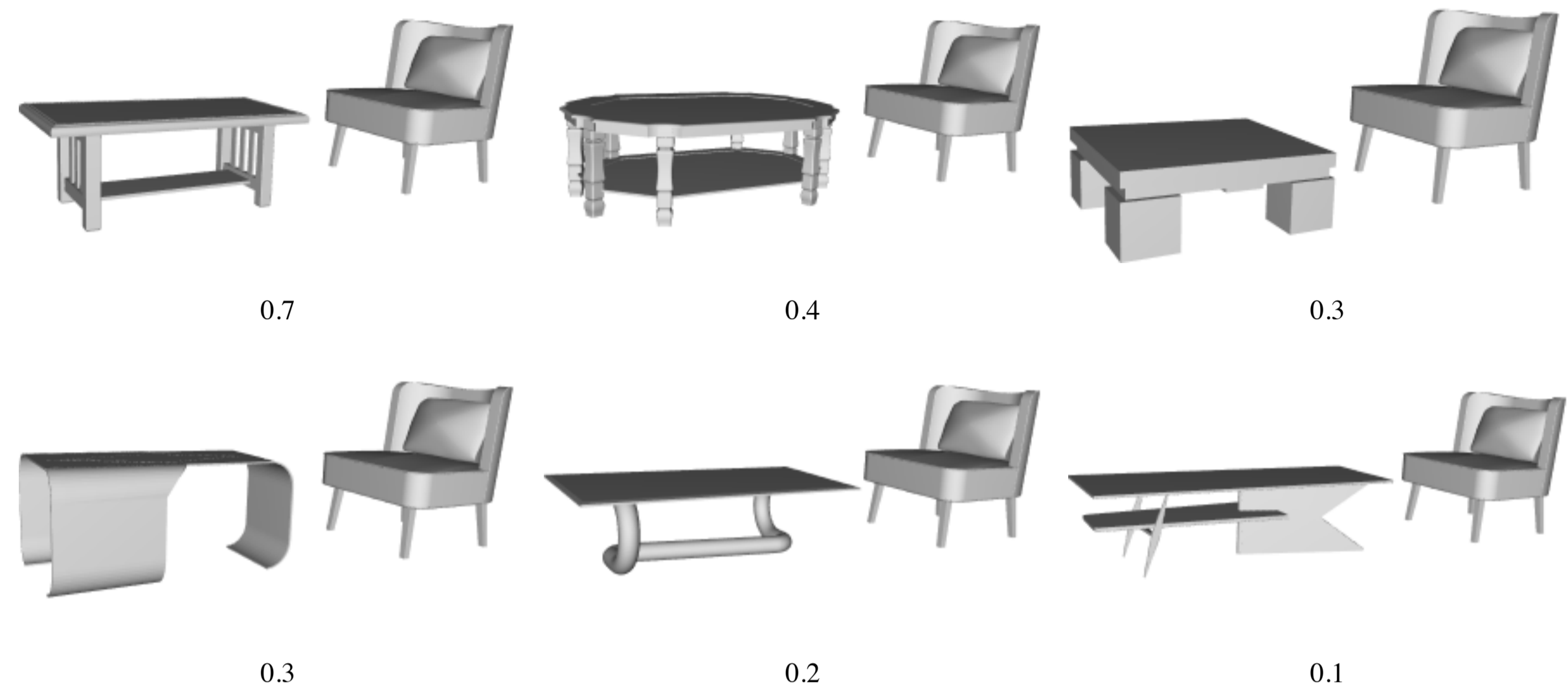

Task 16 of 50 Score = 0.11797

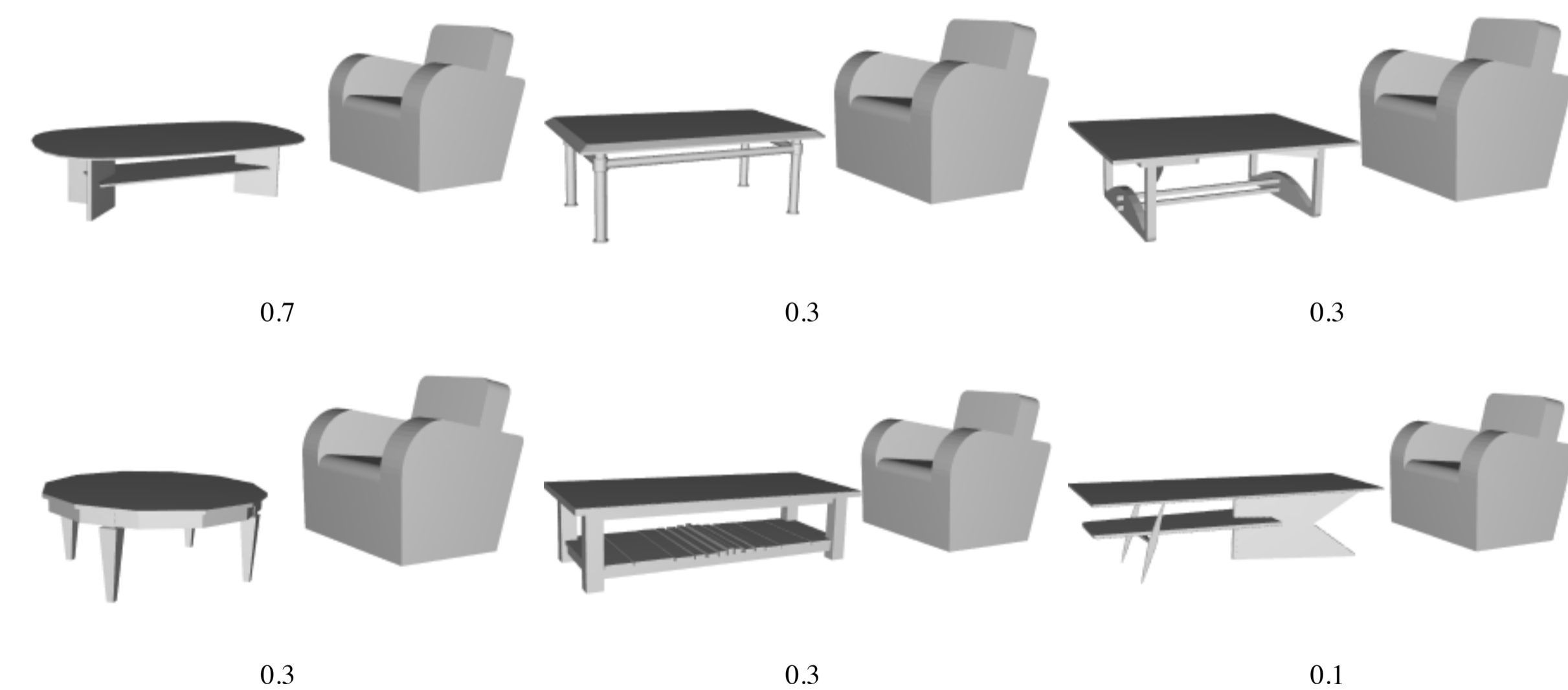

Task 17 of 50 Score = 0.11797



0.7



0.2

0.4

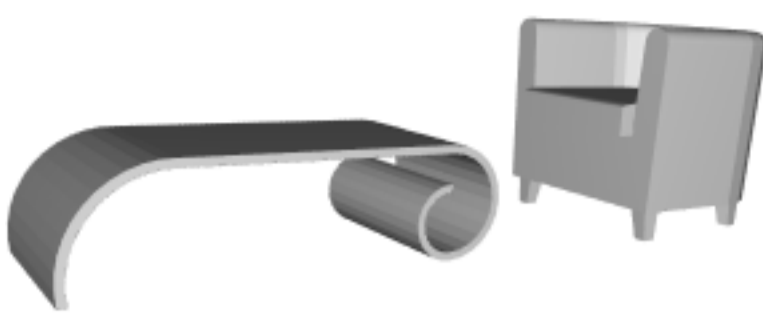

0.2

0.4

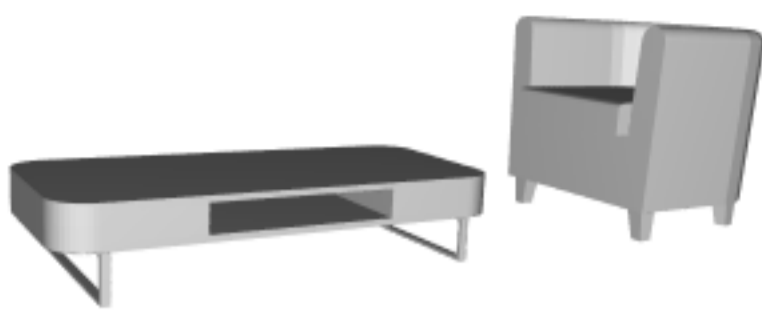

0.1

Task 18 of 50 Score = 0.207929



0.615385



0.384615



0.307692



0.307692



0.230769



0.153846

Task 19 of 50 Score = 0.207929



0.615385



0.384615

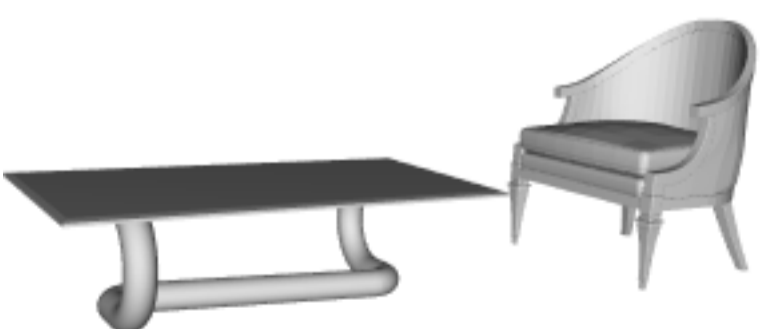

0.307692





0.230769



0.230769



0.230769

Task 20 of 50 Score = 0.459381



0.6



0.5



0.5



0.2



0.1

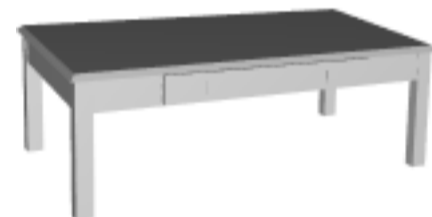

0.1



Task 21 of 50 Score = 0.459381



0.6



0.4

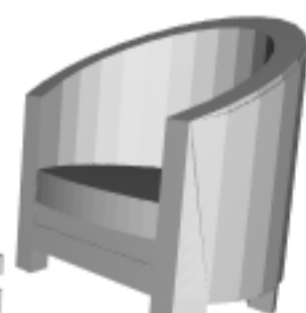

0.3

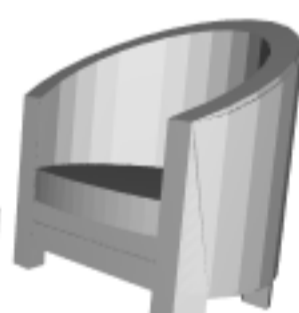

0.3



0.3

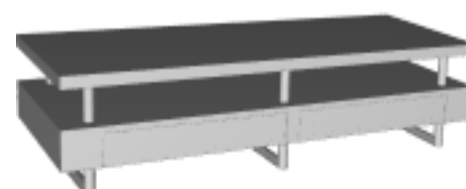

0.1

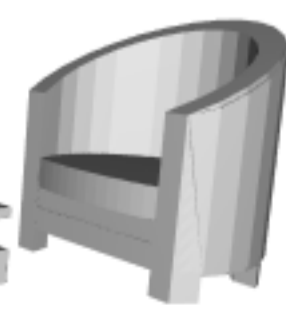

Task 22 of 50 Score = 0.459381

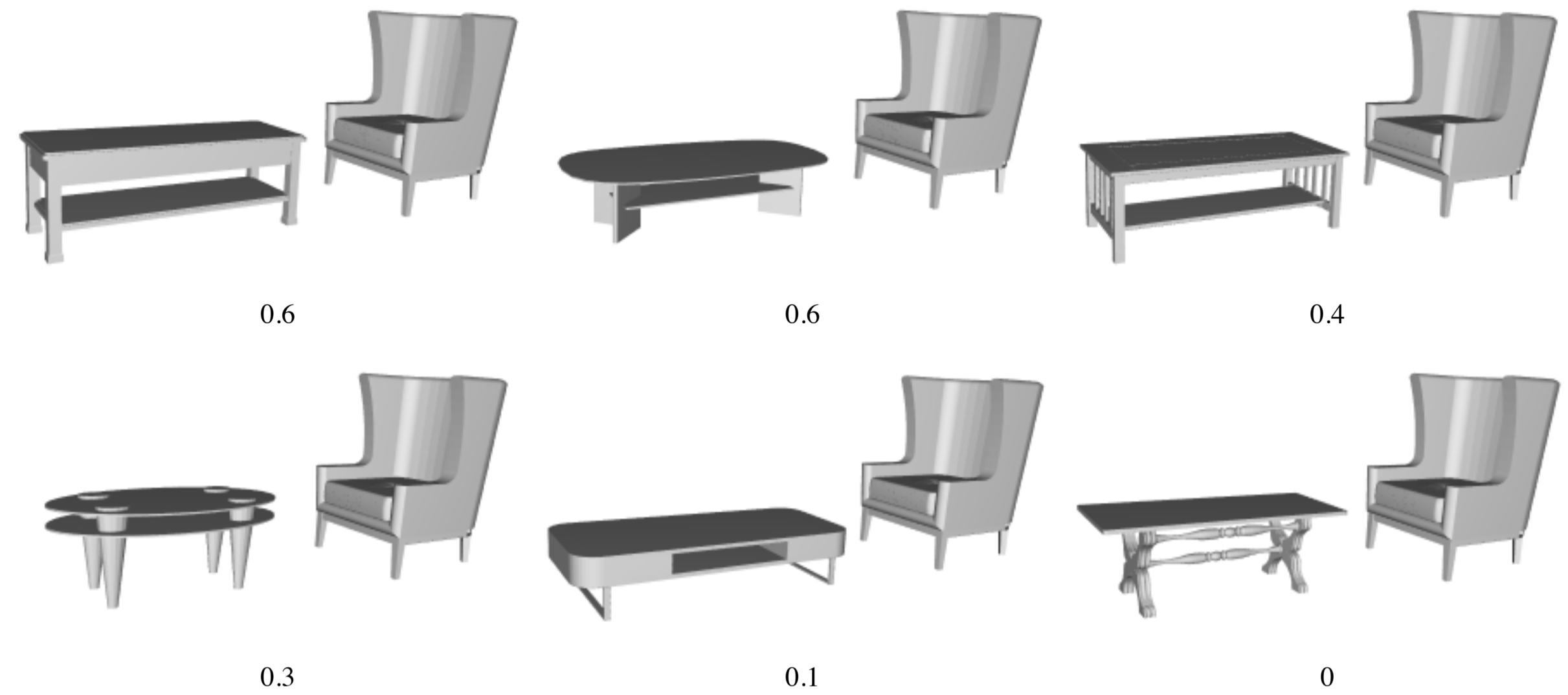

Task 23 of 50 Score = 0.459381

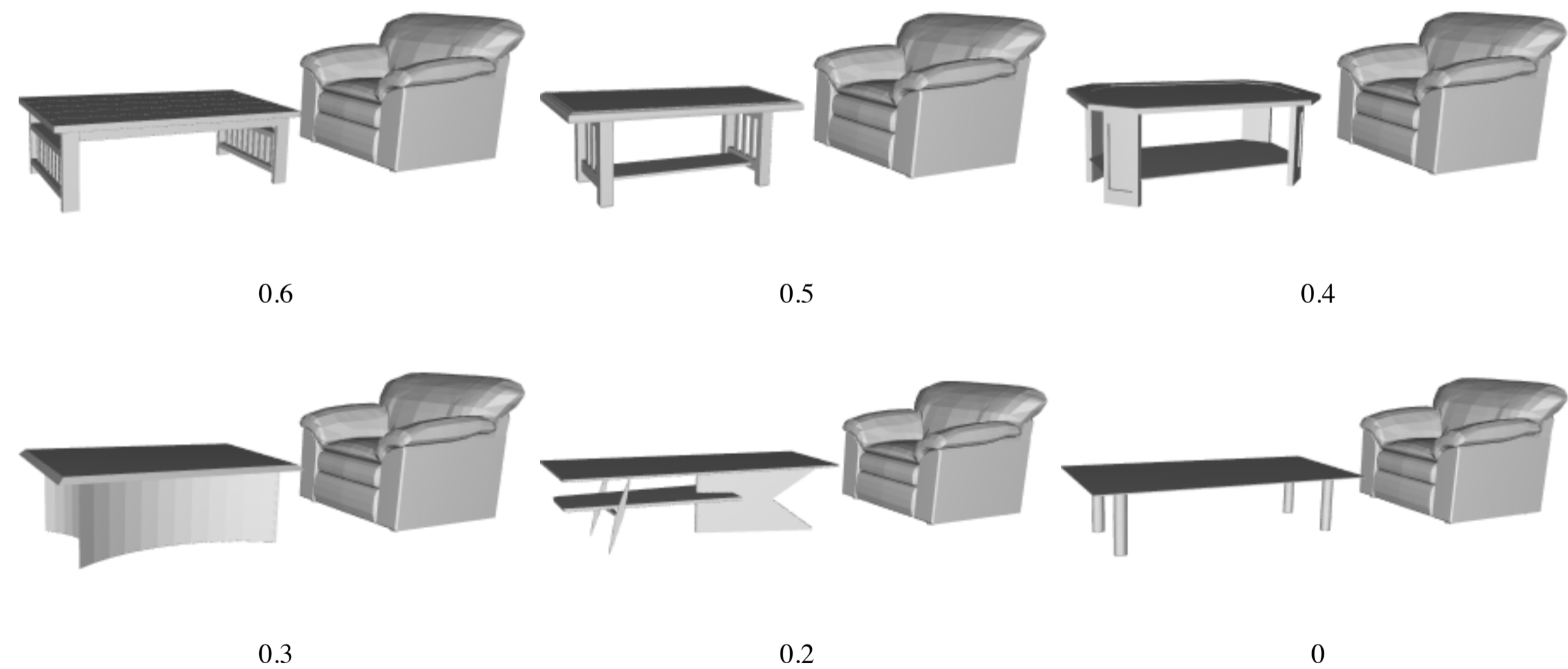

Task 24 of 50 Score = 0.459381



0.6

0.5

0.3



0.3

0.2

0.1

Task 25 of 50 Score = 0.459381

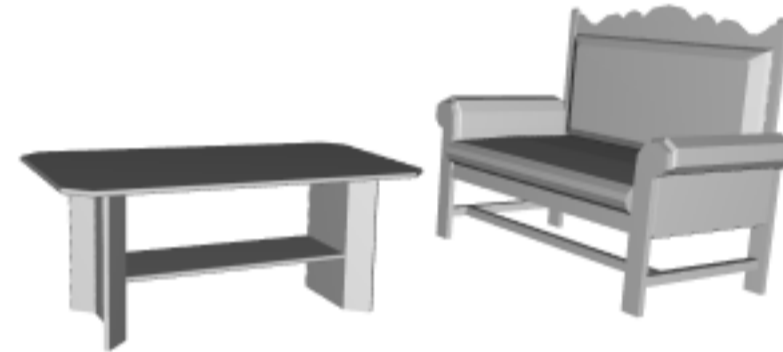
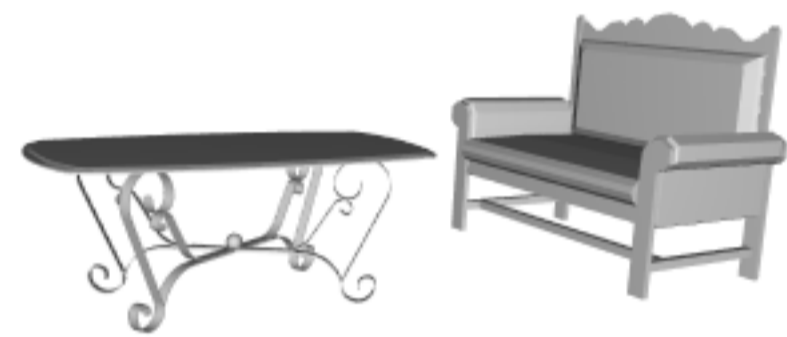

0.6

0.6

0.4

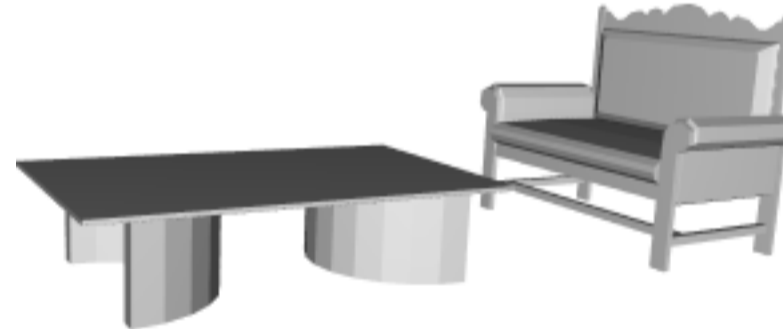

0.2

0.1

0.1

Task 26 of 50 Score = 0.459381



0.6

0.4

0.4



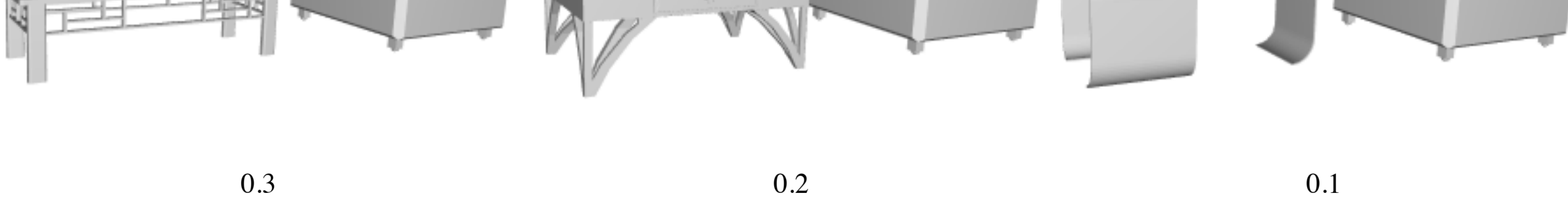

0.3

0.2

0.1

Task 27 of 50 Score = 0.459381



0.6

0.5

0.3

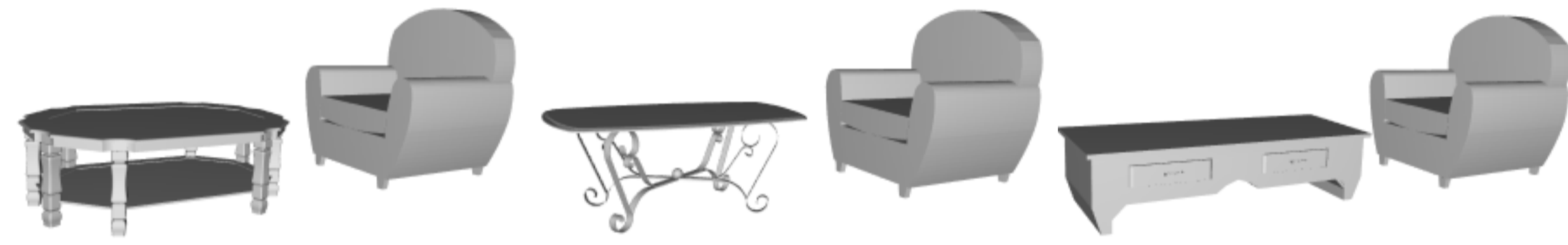

0.2

0.2

0.2

Task 28 of 50 Score = 0.621235



0.538462

0.307692

0.307692

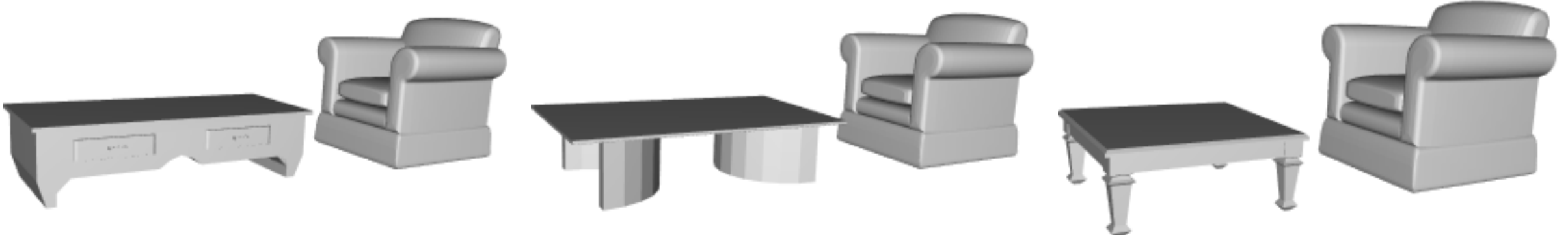

0.307692

0.307692

0.230769

Task 29 of 50 Score = 0.621235



0.538462

0.461538

0.384615

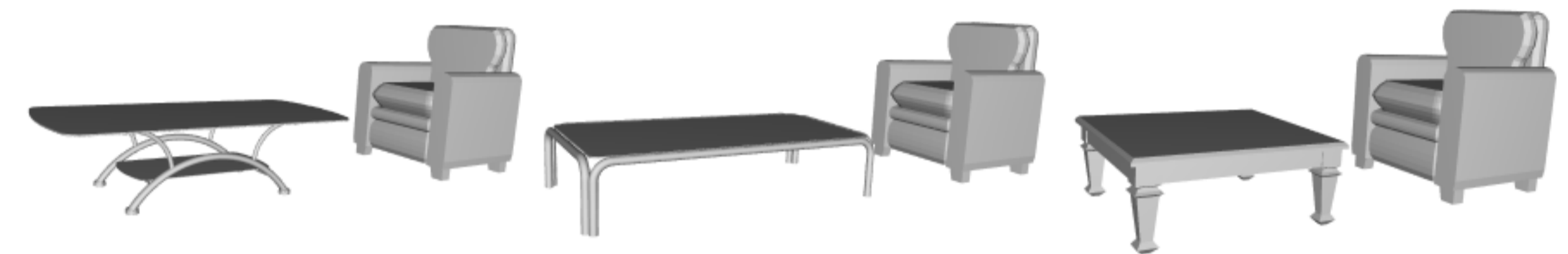

0.307692

0.153846

0.153846

Task 30 of 50 Score = 0.621235

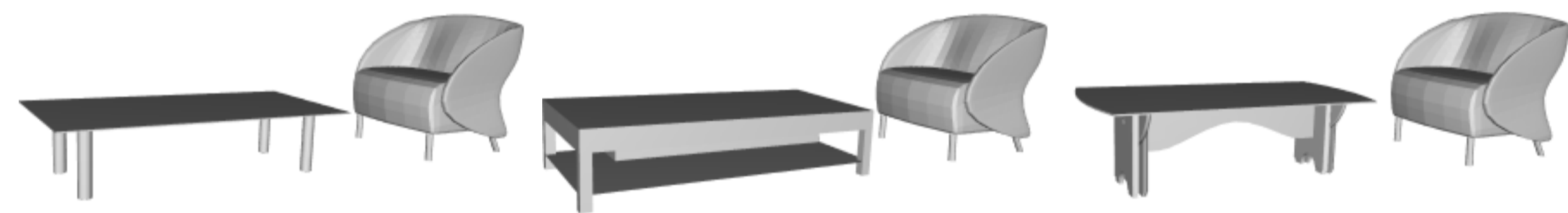

0.538462

0.461538

0.384615

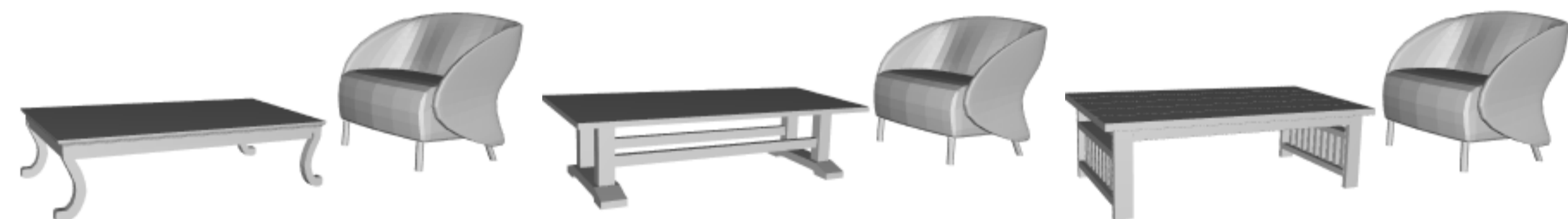

0.307692

0.230769

0.0769231

Task 31 of 50 Score = 0.621235



0.538462

0.461538

0.384615

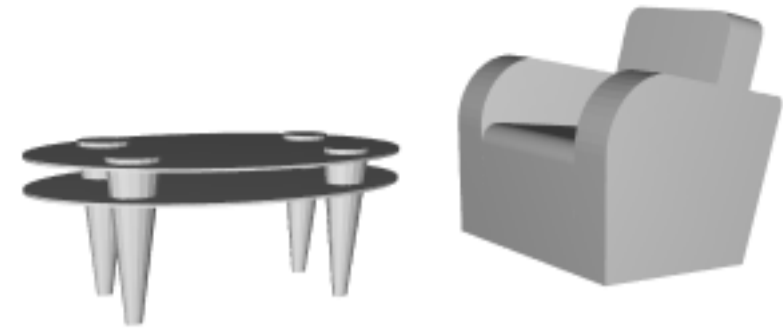
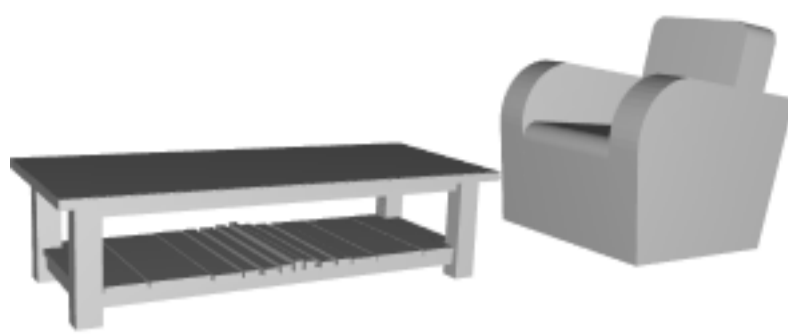
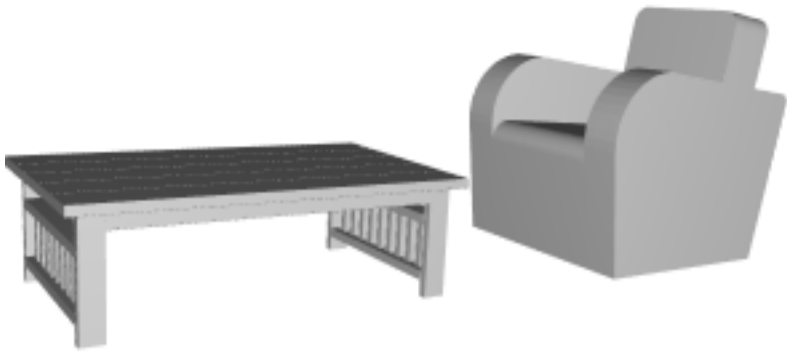

0.230769

0.230769

0.153846

Task 32 of 50 Score = 0.621235



0.538462

0.384615

0.384615



0.307692

0.230769

0.153846

Task 33 of 50 Score = 0.621235

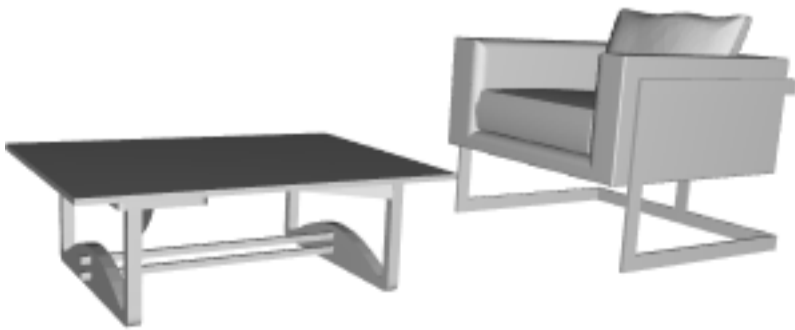

0.538462

0.461538

0.384615





0.307692

0.230769

0.0769231

Task 34 of 50 Score = 0.621235



0.538462

0.461538

0.461538



0.230769

0.230769

0.0769231

Task 35 of 50 Score = 0.621235



0.538462

0.538462

0.384615



0.384615

0.153846

0

Task 36 of 50 Score = 0.621235

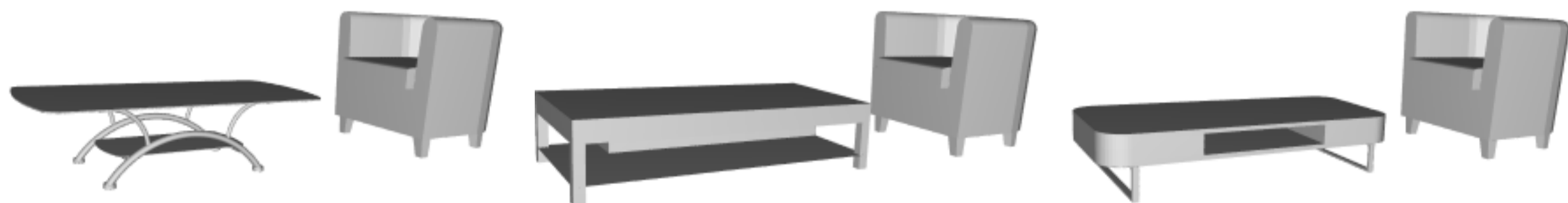

0.538462

0.538462

0.384615

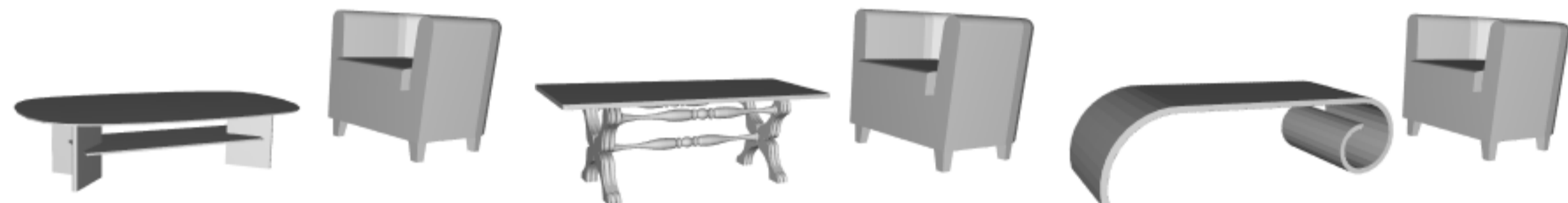

0.230769

0.230769

0.0769231

Task 37 of 50 Score = 0.621235

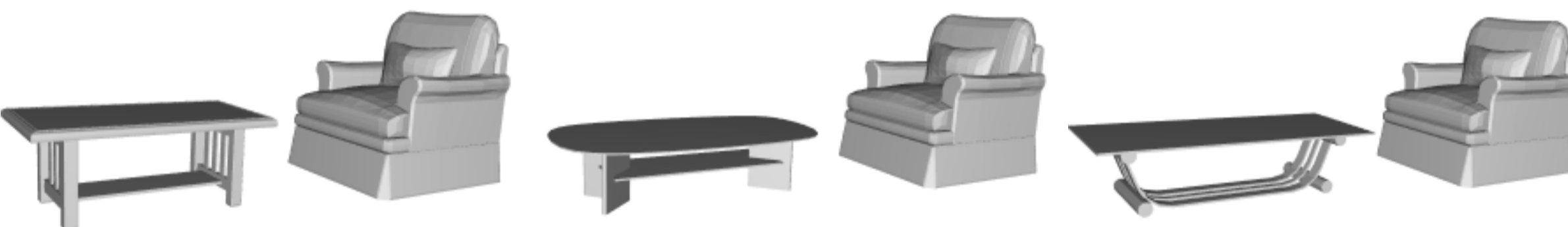

0.538462

0.384615

0.384615

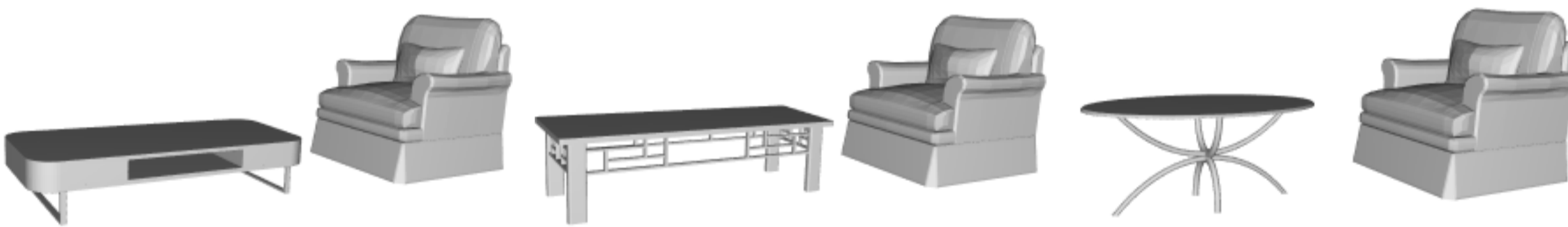

0.384615

0.230769

0.0769231

Task 38 of 50 Score = 1.27877



0.5



0.3



0.4

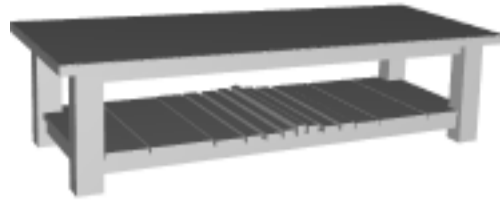

0.3



0.4



0.1



Task 39 of 50 Score = 1.27877

0.5

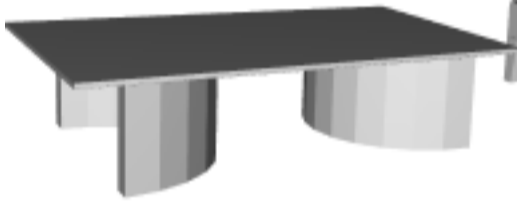

0.3



0.4



0.2



0.4

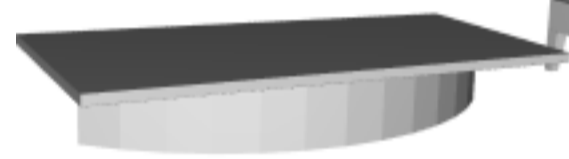

0.2



0.5



0.5



0.5



0.5



0.4

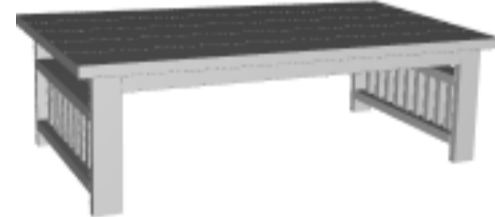

0.4



Task 40 of 50 Score = 1.27877

0.5



0.5



0.4



0.4

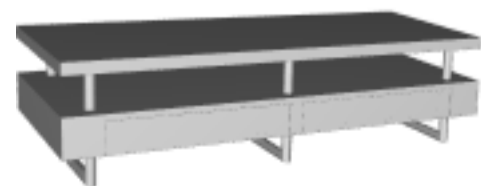

0.4



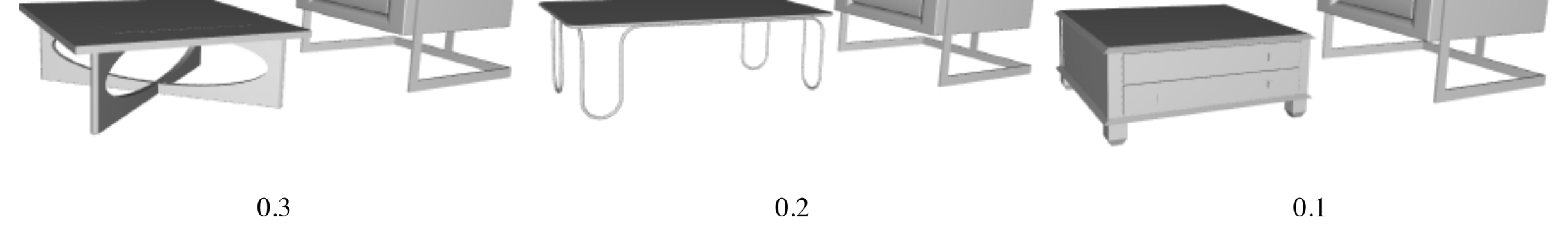

Task 41 of 50 Score = 1.27877

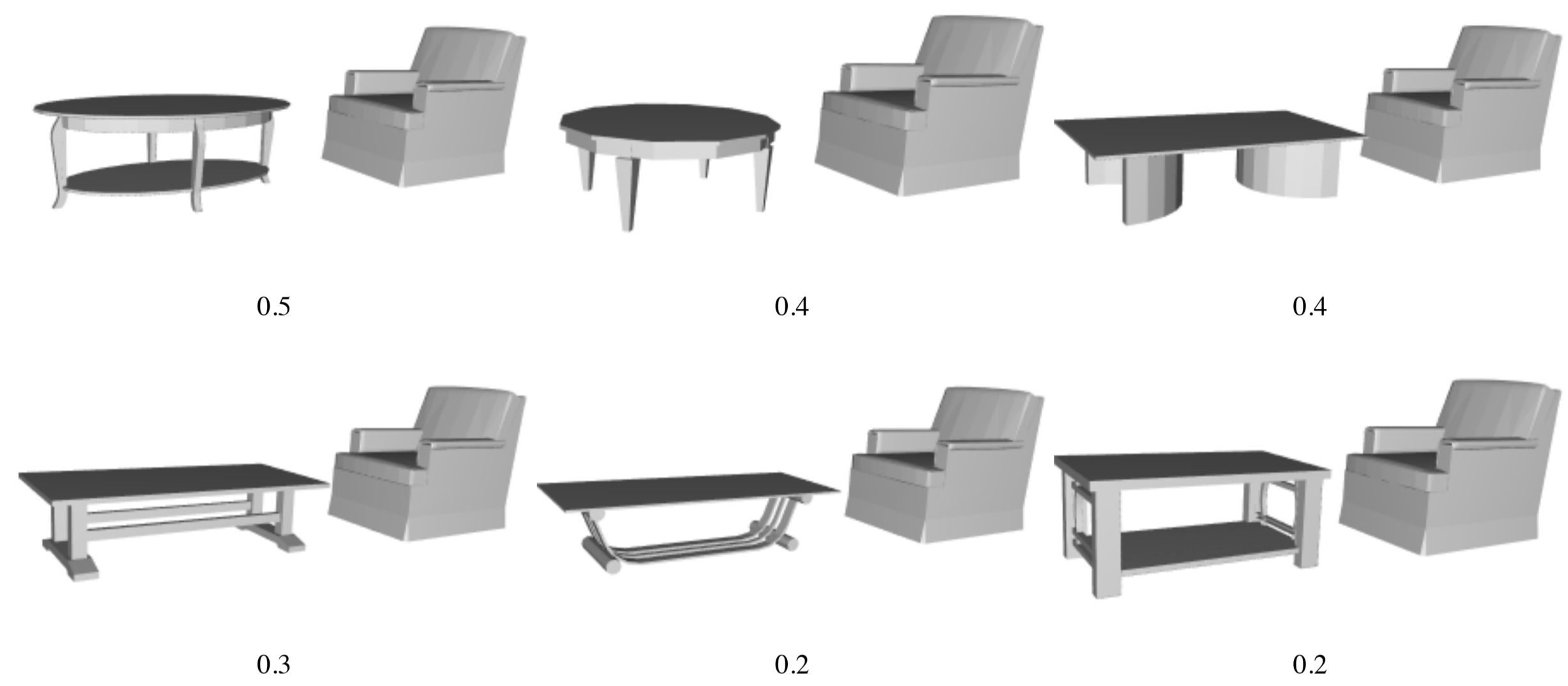

Task 42 of 50 Score = 1.27877

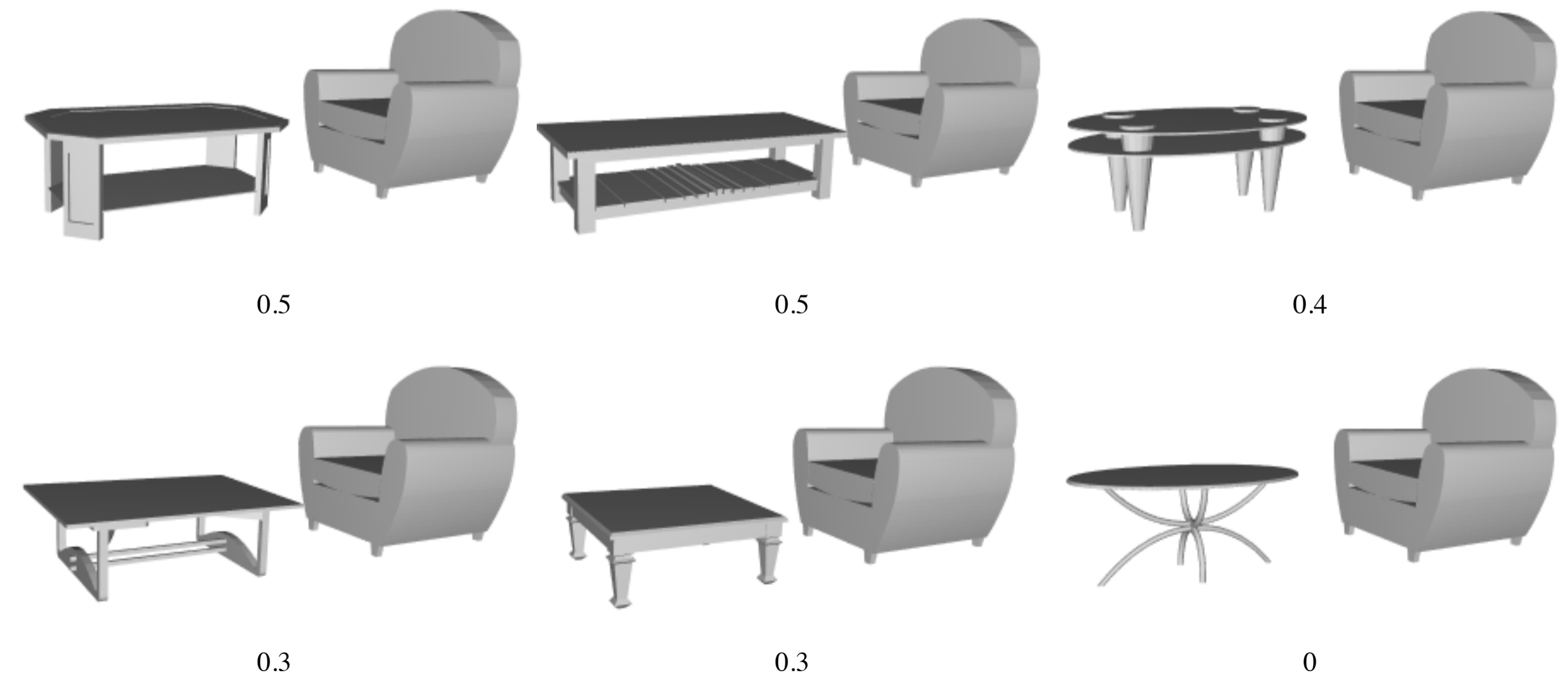

Task 43 of 50 Score = 1.44785



0.461538

0.384615

0.384615

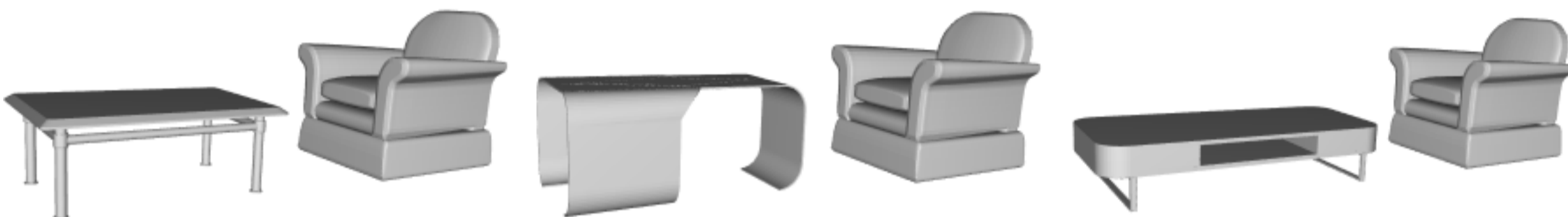

0.307692

0.230769

0.230769

Task 44 of 50 Score = 1.44785



0.461538

0.461538

0.384615



0.384615

0.307692

0

Task 45 of 50 Score = 1.44785



0.461538



0.307692

0.461538



0.153846

0.461538



0.153846

Task 46 of 50 Score = 1.44785

0.461538



0.384615

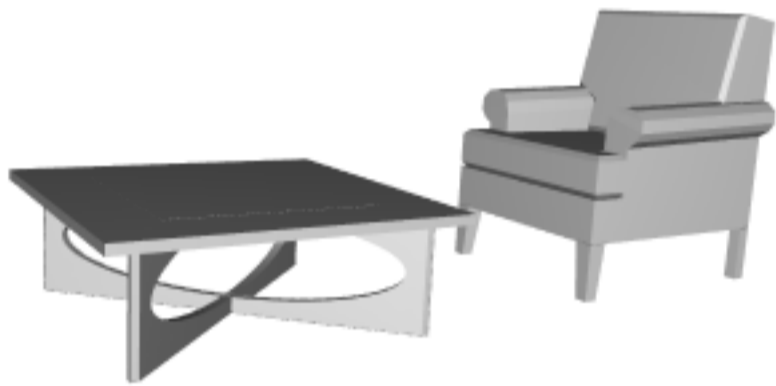

0.384615



0.307692



0.307692

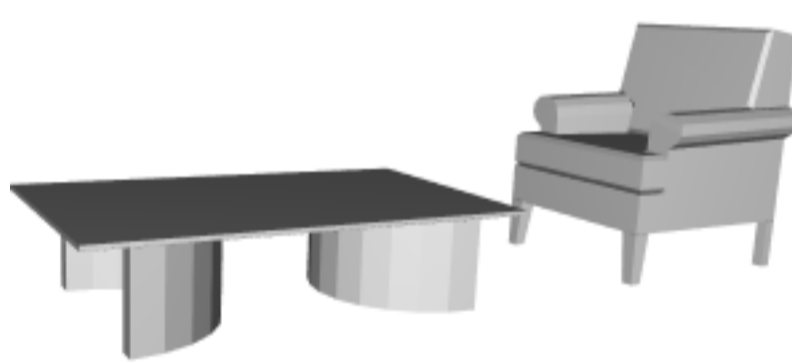

0.153846



Task 47 of 50 Score = 2.64441

0.4

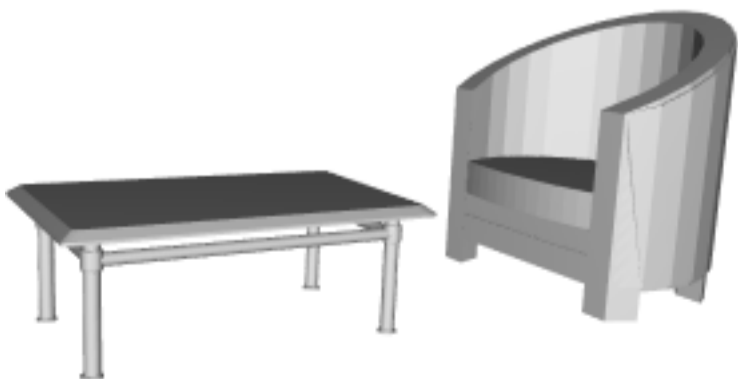

0.4

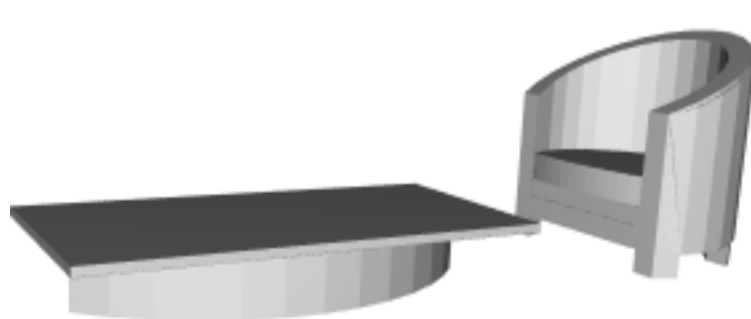

0.4

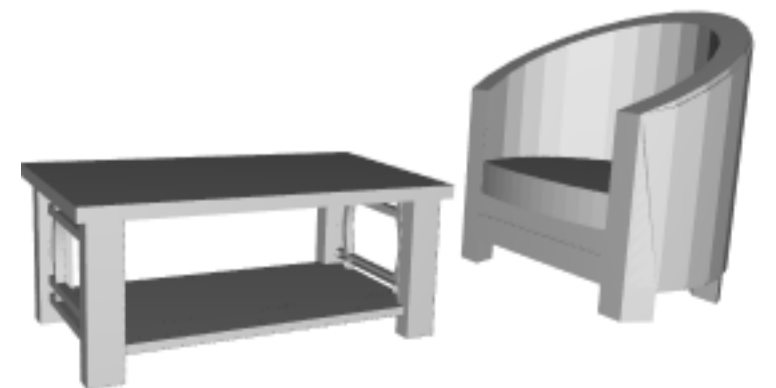

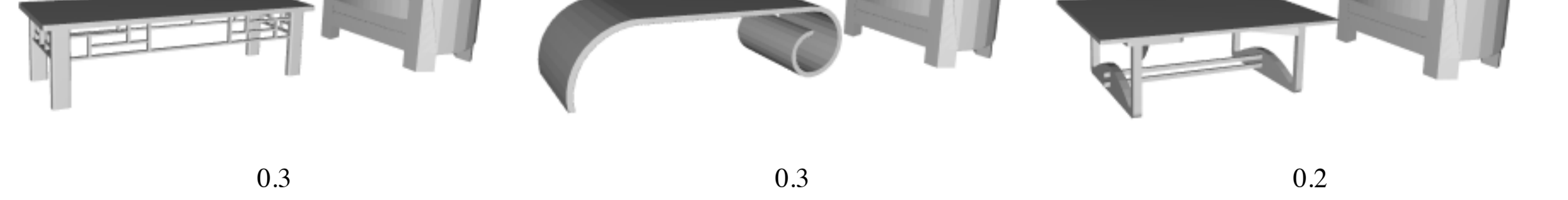

0.3

0.3

0.2

Task 48 of 50 Score = 2.64441



0.4

0.4

0.4



0.4

0.2

0.2

Task 49 of 50 Score = 2.68777



0.384615

0.384615

0.384615

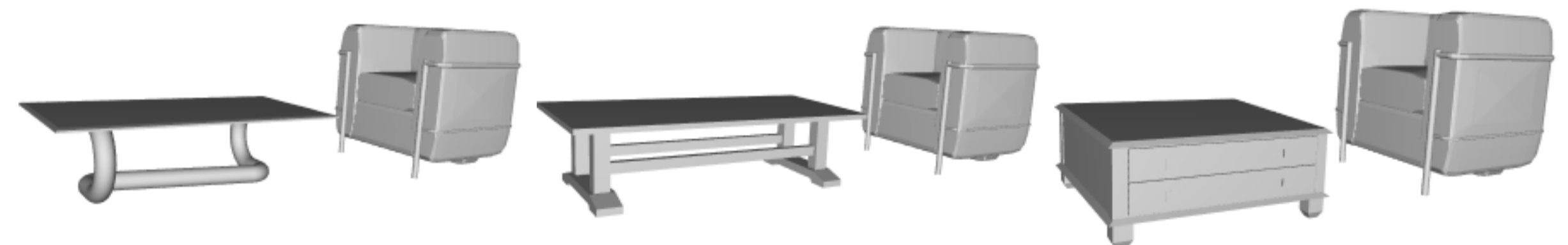

0.307692

0.307692

0.230769

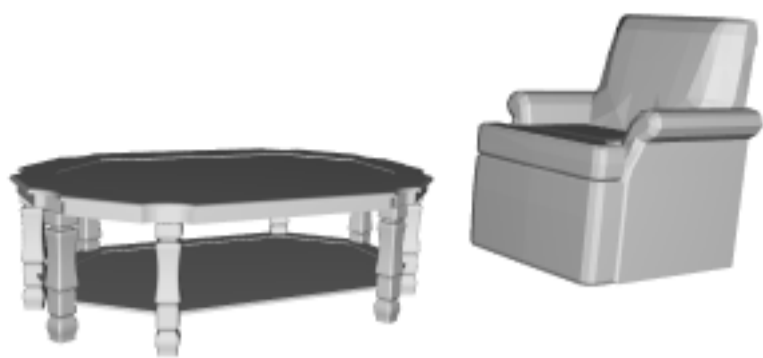

0.384615

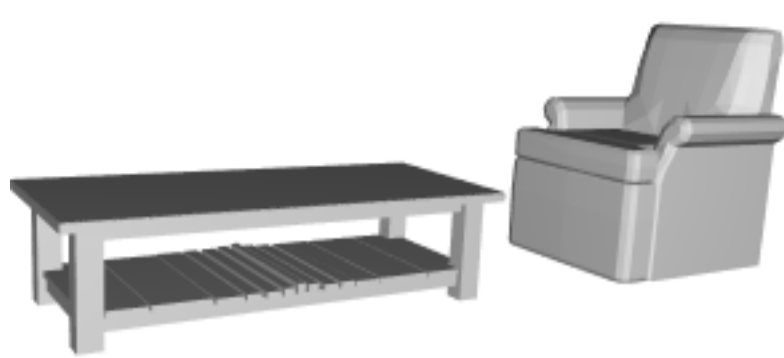

0.384615

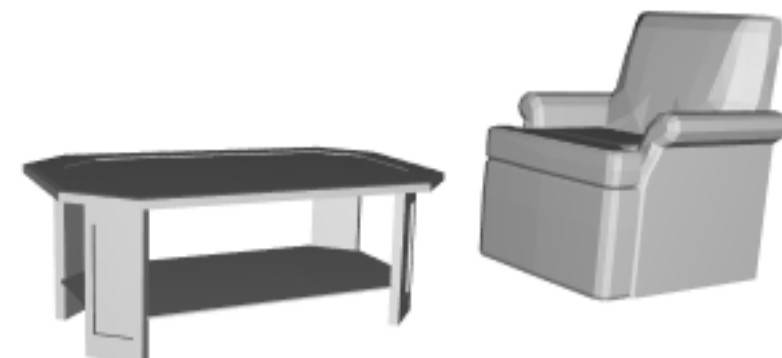

0.307692

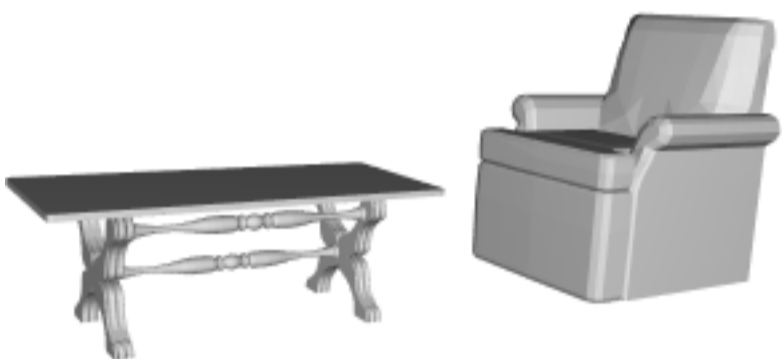

0.307692



0.307692

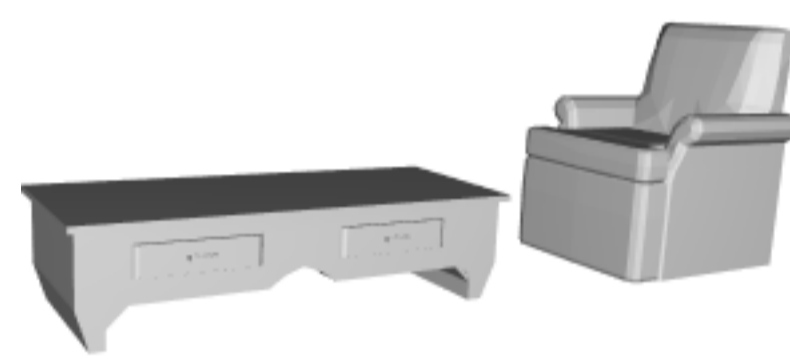

0.307692
