

Task 1 of 50 Score = 0.00127578

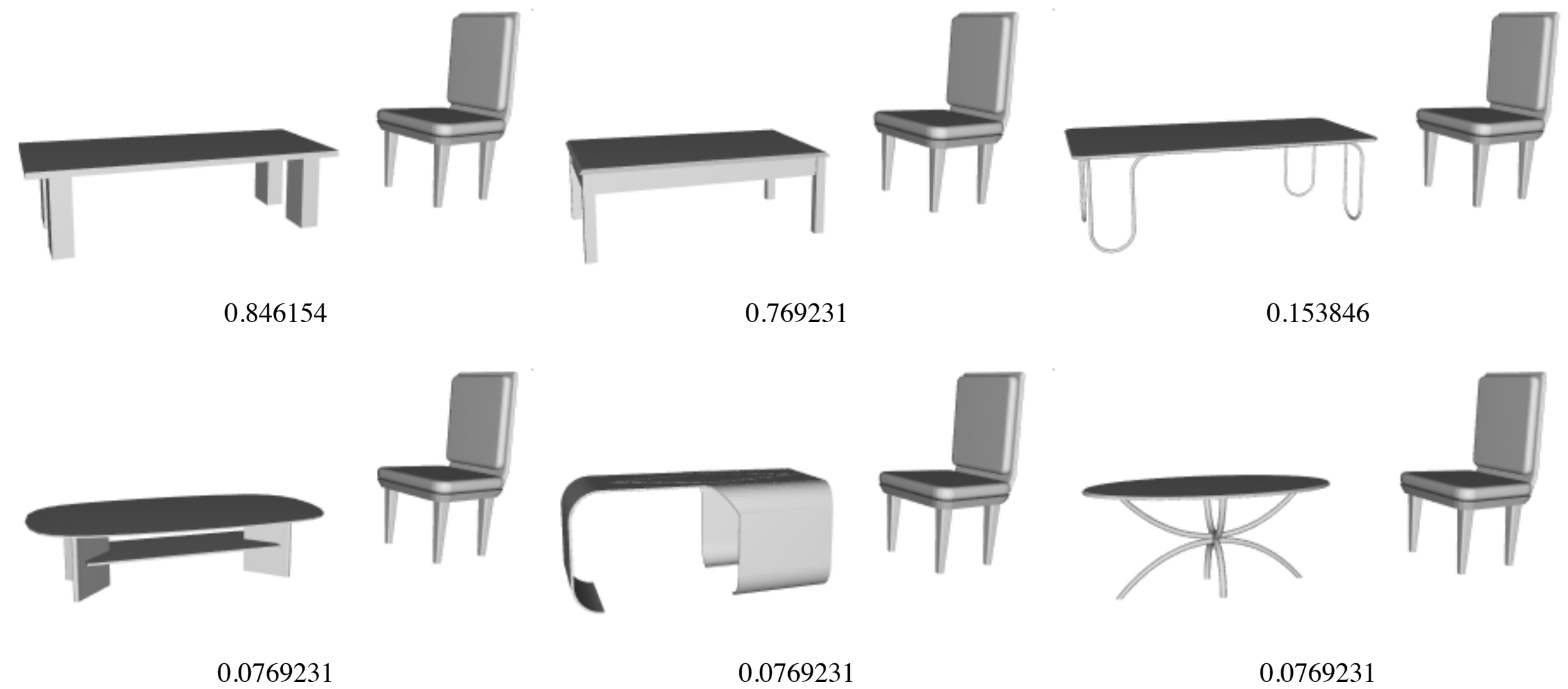

Task 2 of 50 Score = 0.00228479

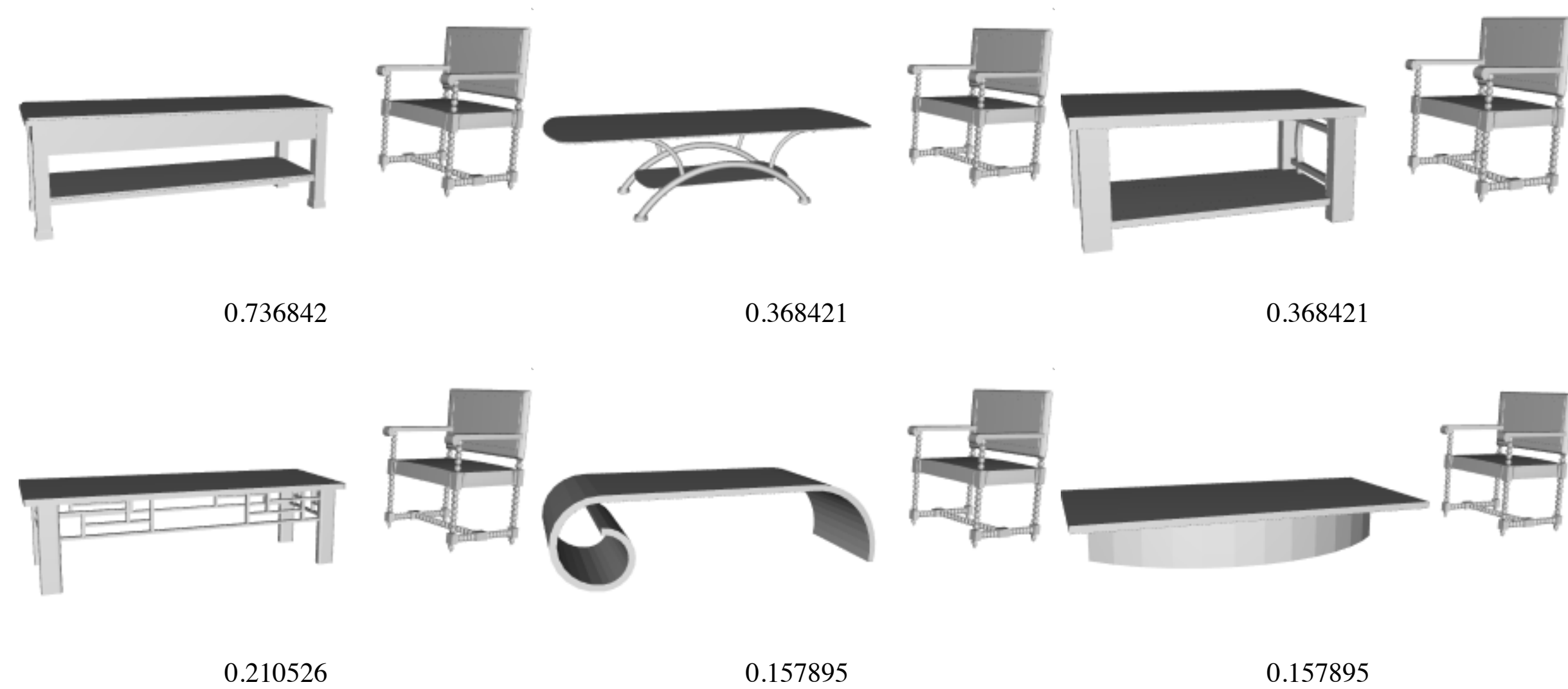

Task 3 of 50 Score = 0.00988633





0.769231



0.461538



0.384615



0.384615

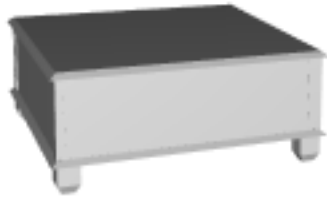

0



0



Task 4 of 50 Score = 0.00988633



0.769231



0.615385

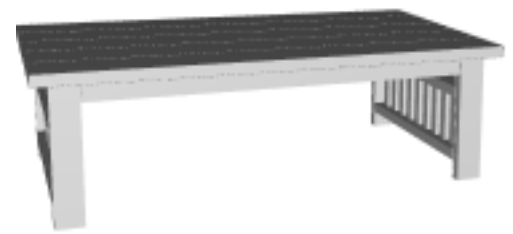

0.307692



0.230769

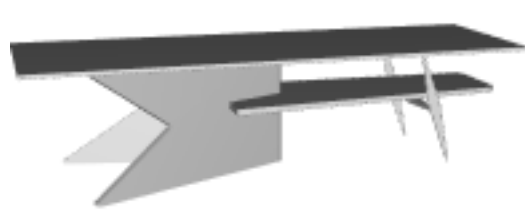

0.0769231

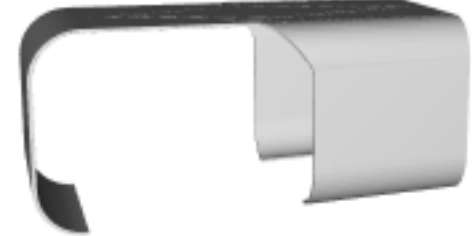

0



Task 5 of 50 Score = 0.0112489



0.684211



0.631579



0.315789



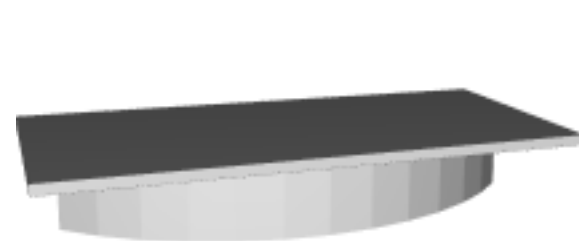
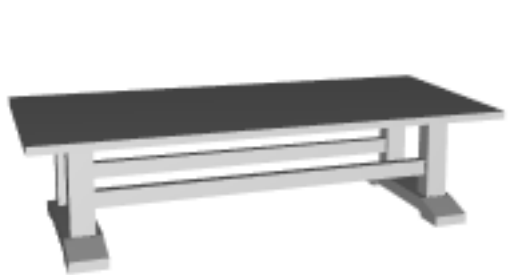

0.210526

0.105263

0.0526316

Task 6 of 50 Score = 0.0112489



0.684211

0.368421

0.315789



0.210526

0.210526

0.210526

Task 7 of 50 Score = 0.0112489

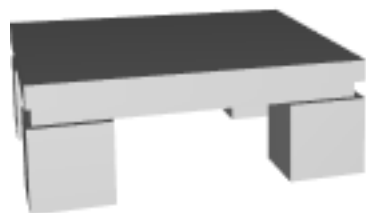

0.684211

0.473684

0.315789



0.315789

0.157895

0.0526316

Task 8 of 50 Score = 0.0112489

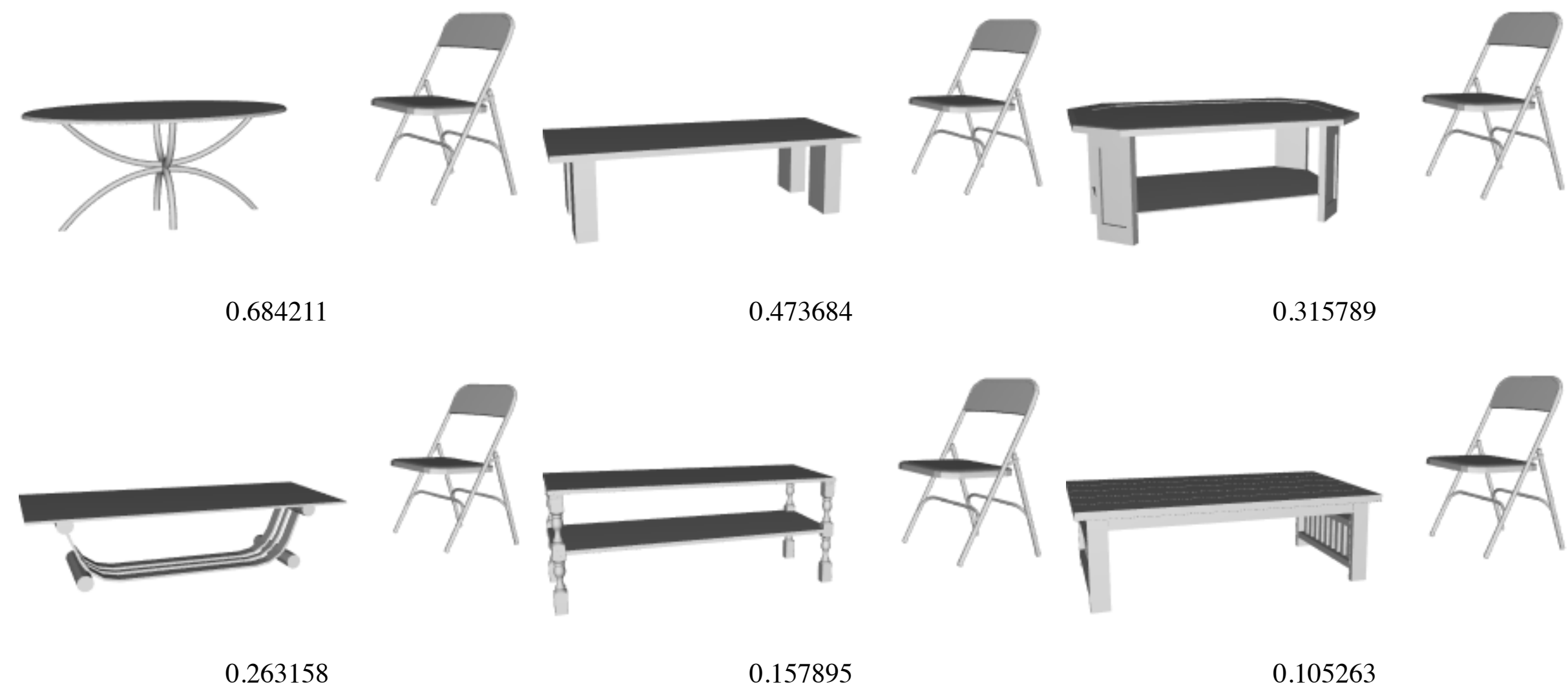

Task 9 of 50 Score = 0.0445444



Task 10 of 50 Score = 0.0445444



0.631579

0.578947

0.368421

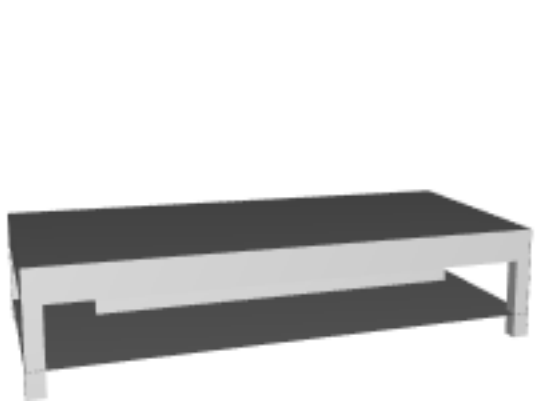

0.315789

0.105263

0

Task 11 of 50 Score = 0.0445444

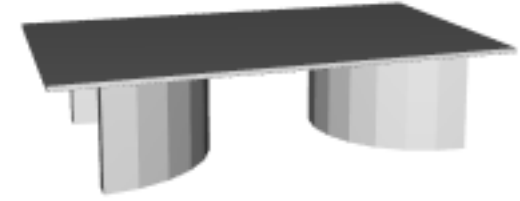

0.631579

0.473684

0.315789

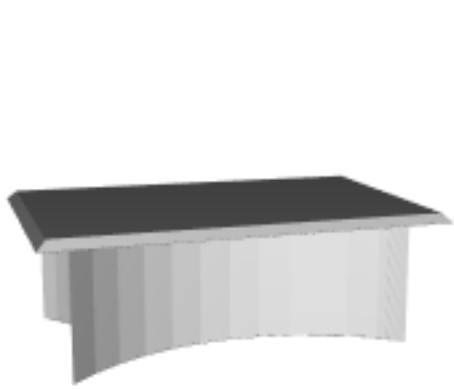

0.263158

0.157895

0.157895

Task 12 of 50 Score = 0.0445444

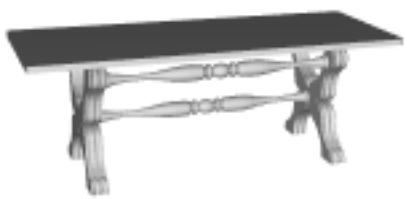

0.631579

0.473684

0.315789





0.263158



0.157895

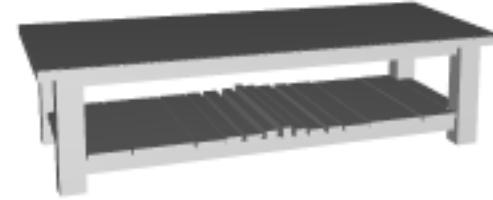

0.157895



Task 13 of 50 Score = 0.0445444



0.631579

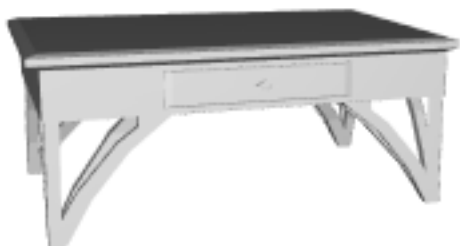

0.473684



0.315789



0.210526



0.210526



0.157895



Task 14 of 50 Score = 0.0529391



0.692308

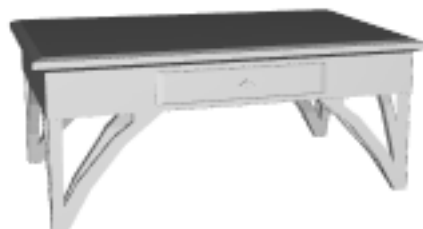

0.538462

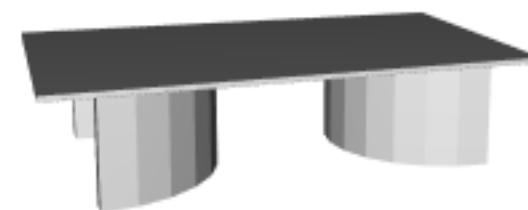

0.384615



0.230769



0.153846

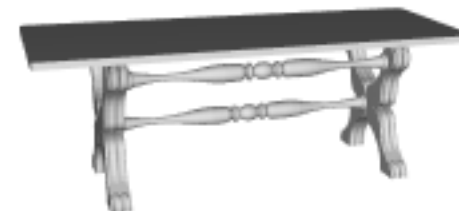

0



Task 15 of 50 Score = 0.0529391



0.692308



0.307692



0.307692



0.307692



0.230769



0.153846



Task 16 of 50 Score = 0.0529391



0.692308



0.384615



0.307692



0.230769



0.230769



0.153846



Task 17 of 50 Score = 0.144431



0.578947

0.368421

0.368421

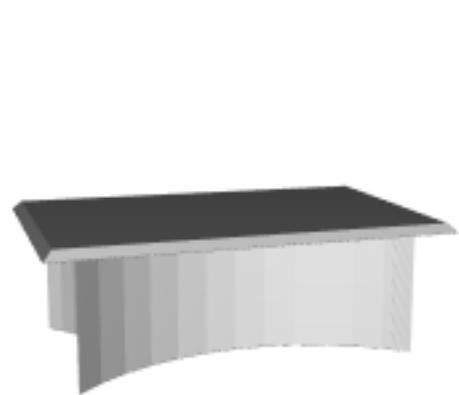

0.315789

0.210526

0.157895

Task 18 of 50 Score = 0.144431

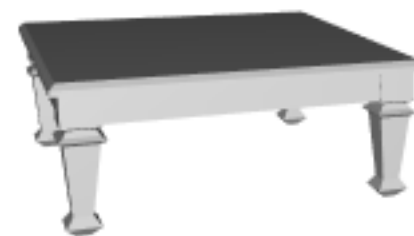

0.578947

0.473684

0.368421



0.263158

0.210526

0.105263

Task 19 of 50 Score = 0.144431



0.578947

0.368421

0.368421





0.315789



0.263158



0.105263



Task 20 of 50 Score = 0.144431

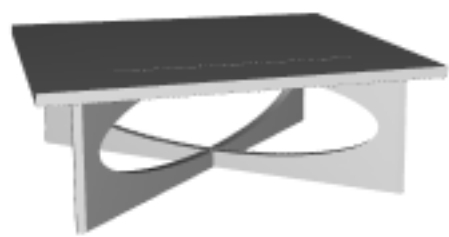

0.578947



0.421053



0.421053



0.210526

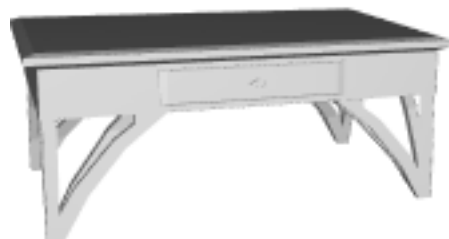

0.210526

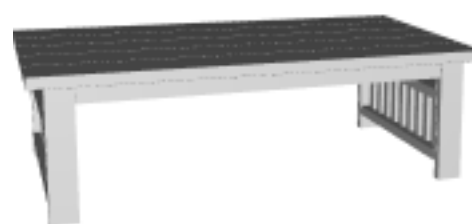

0.157895



Task 21 of 50 Score = 0.144431

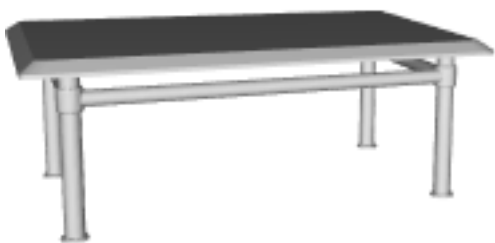

0.578947



0.421053



0.368421



0.263158



0.210526

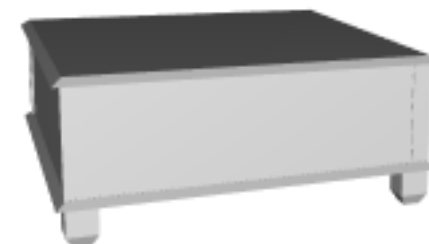

0.157895



Task 22 of 50 Score = 0.144431

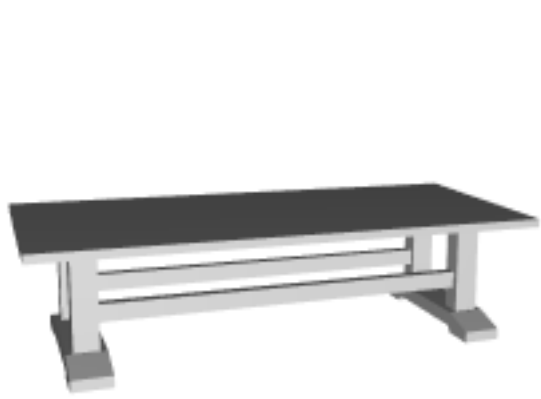

0.578947

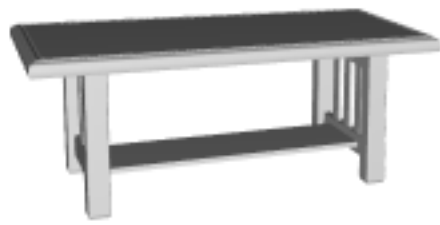

0.526316



0.368421



0.210526



0.210526

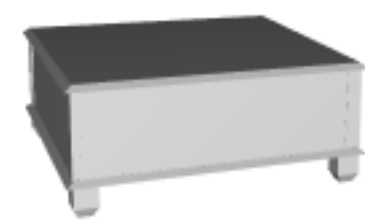

0.105263



Task 23 of 50 Score = 0.207929

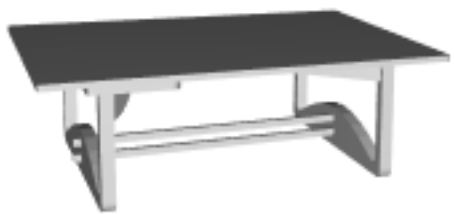

0.615385



0.461538



0.384615



0.307692



0.153846



0.0769231



Task 24 of 50 Score = 0.207929

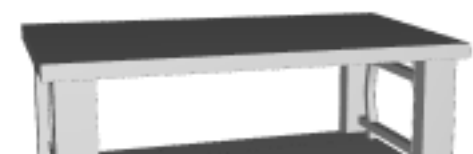

0.615385

0.461538

0.384615

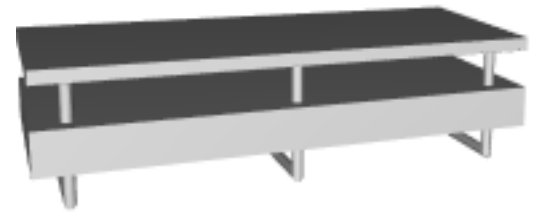
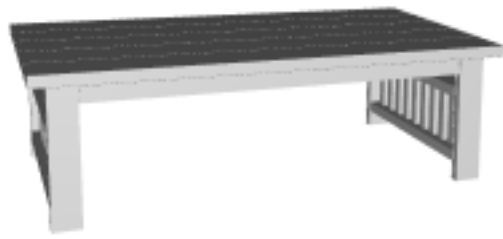
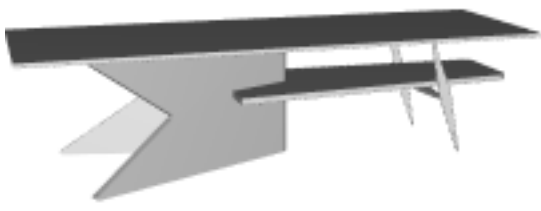

0.230769

0.153846

0.153846

Task 25 of 50 Score = 0.207929

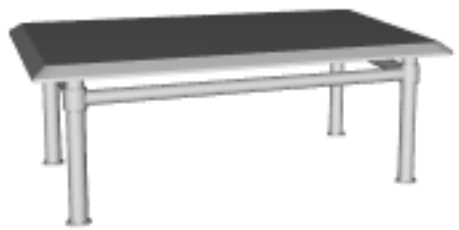

0.615385

0.461538

0.307692

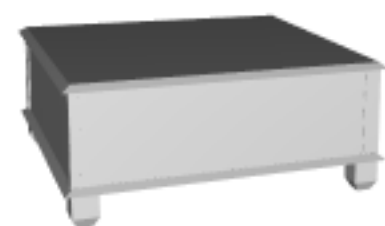

0.307692

0.153846

0.153846

Task 26 of 50 Score = 0.207929

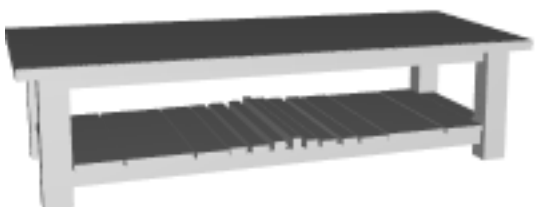

0.615385

0.538462

0.307692





0.307692

0.153846

0.0769231

Task 27 of 50 Score = 0.207929



0.615385

0.615385

0.538462



0.0769231

0.0769231

0.0769231

Task 28 of 50 Score = 0.207929

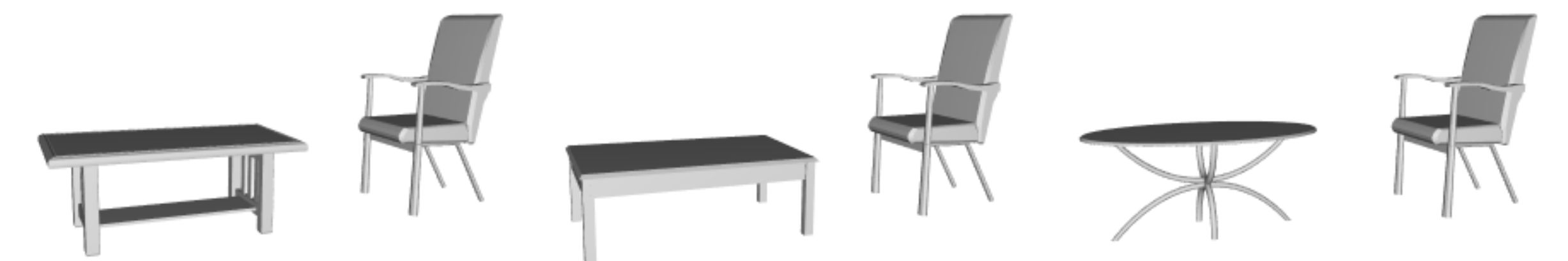

0.615385

0.538462

0.384615

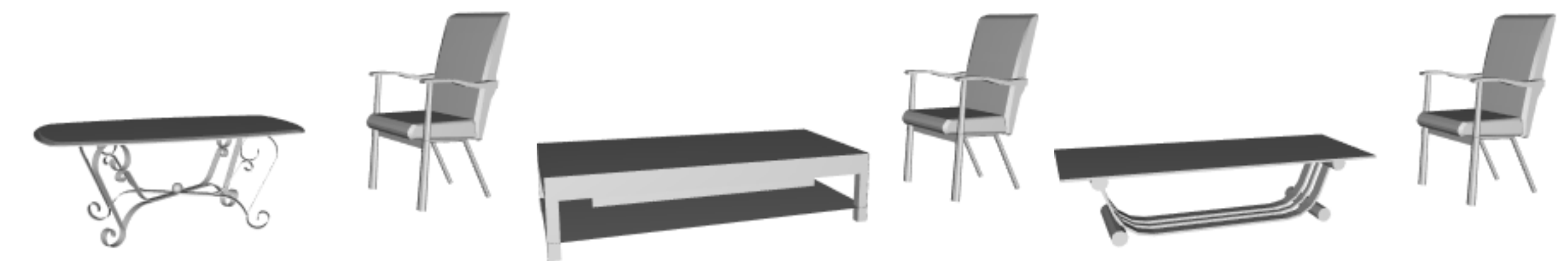

0.230769

0.153846

0.0769231

Task 29 of 50 Score = 0.207929



Task 30 of 50 Score = 0.207929



Task 31 of 50 Score = 0.388597



0.526316

0.473684

0.473684

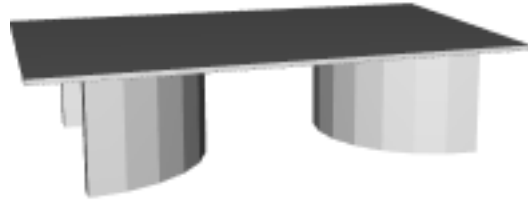
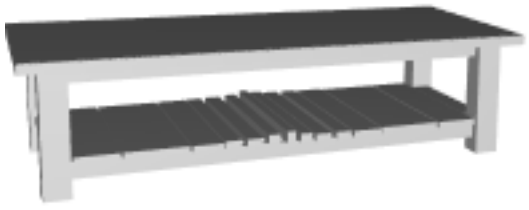

0.210526

0.210526

0.105263

Task 32 of 50 Score = 0.388597



0.526316

0.368421

0.368421

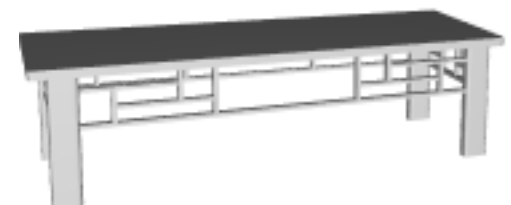

0.315789

0.263158

0.157895

Task 33 of 50 Score = 0.388597



0.526316

0.473684

0.368421





0.315789



0.210526



0.105263

Task 34 of 50 Score = 0.388597



0.526316



0.473684

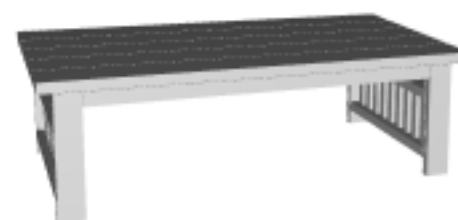

0.263158



0.263158



0.263158



0.210526



Task 35 of 50 Score = 0.388597



0.526316



0.526316



0.368421



0.315789

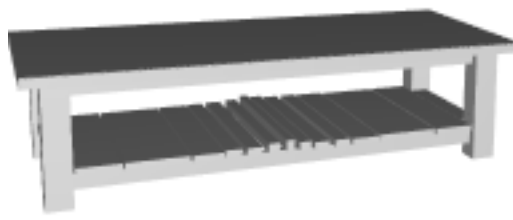

0.157895



0.105263



Task 36 of 50 Score = 0.621235



0.538462

0.538462

0.384615

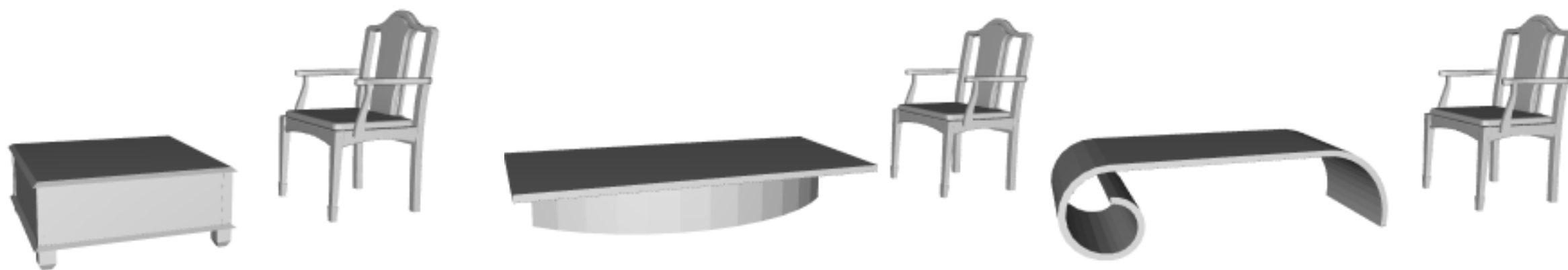

0.384615

0.153846

0

Task 37 of 50 Score = 0.621235



0.538462

0.461538

0.461538

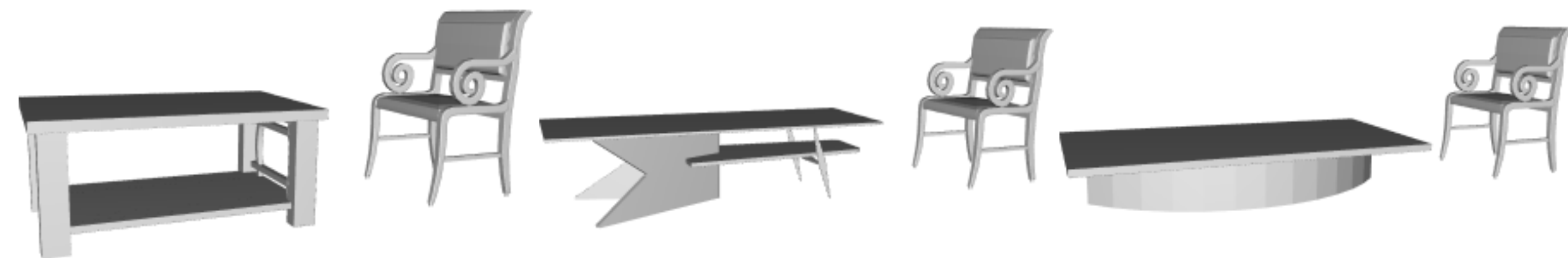

0.384615

0.0769231

0.0769231

Task 38 of 50 Score = 0.621235



0.538462

0.538462

0.307692

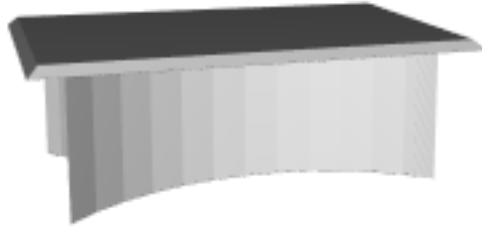

0.230769

0.230769

0.153846

Task 39 of 50 Score = 0.621235



0.538462

0.538462

0.307692

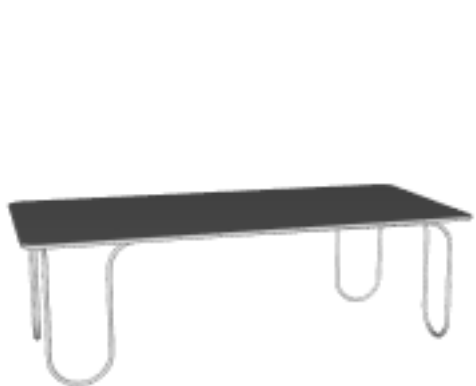

0.230769

0.230769

0.153846

Task 40 of 50 Score = 0.621235

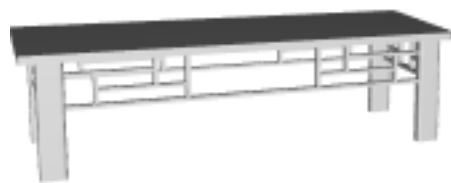
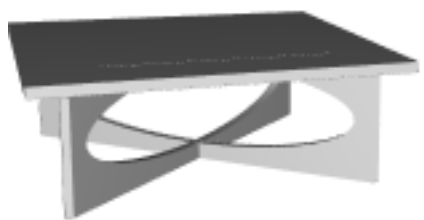

0.538462

0.461538

0.307692





0.307692



0.307692



0.0769231



Task 41 of 50 Score = 0.621235



0.538462



0.384615



0.307692

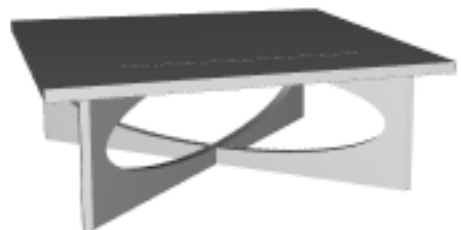

0.307692



0.230769



0.230769



Task 42 of 50 Score = 0.87693



0.473684



0.473684



0.421053

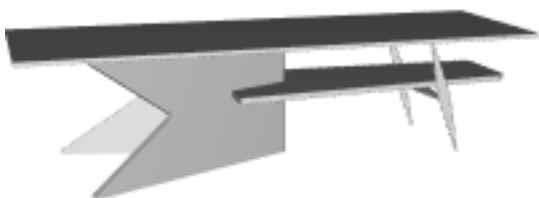

0.210526



0.210526



0.210526



Task 43 of 50 Score = 0.87693



0.473684

0.368421

0.368421



0.315789

0.315789

0.157895

Task 44 of 50 Score = 0.87693

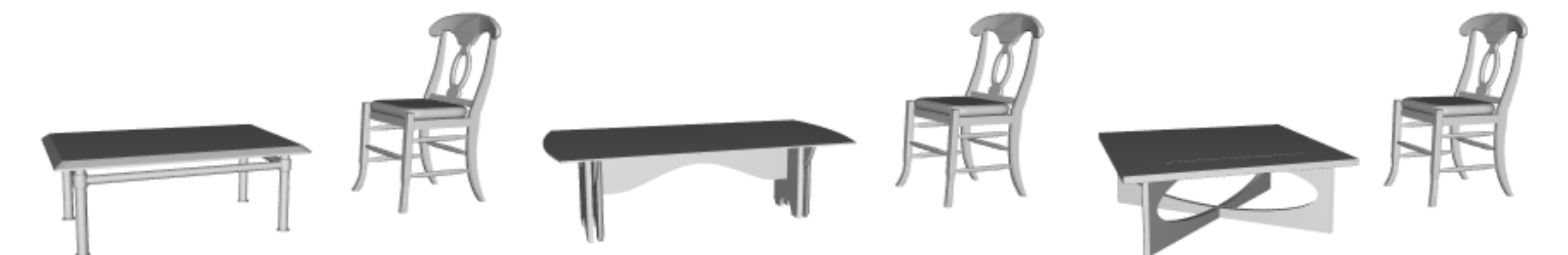

0.473684

0.421053

0.368421



0.368421

0.315789

0.0526316

Task 45 of 50 Score = 1.44785



0.461538

0.461538

0.384615

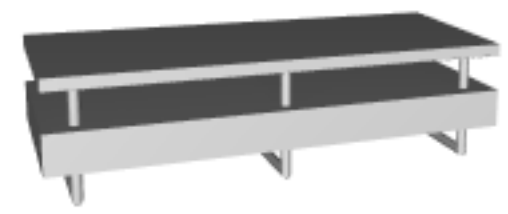

0.384615

0.153846

0.153846

Task 46 of 50 Score = 1.44785

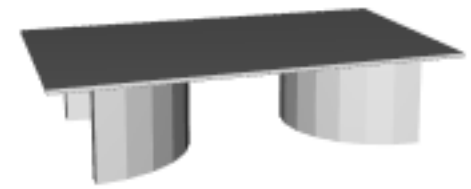

0.461538

0.384615

0.384615

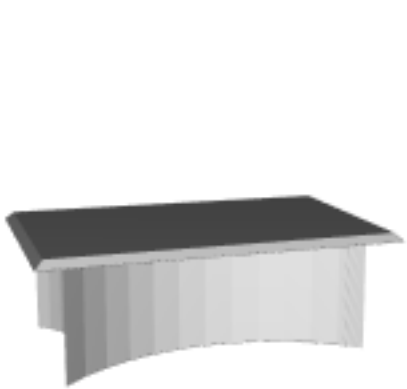

0.307692

0.230769

0.230769

Task 47 of 50 Score = 1.44785

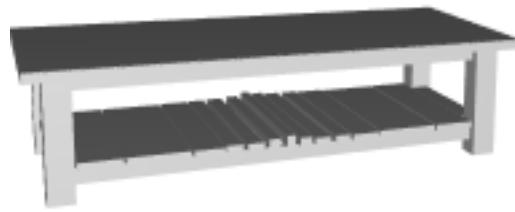
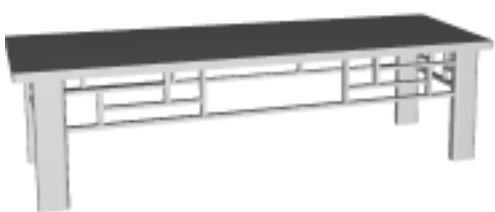

0.461538

0.461538

0.384615





0.384615

0.307692

0

Task 48 of 50 Score = 1.44785

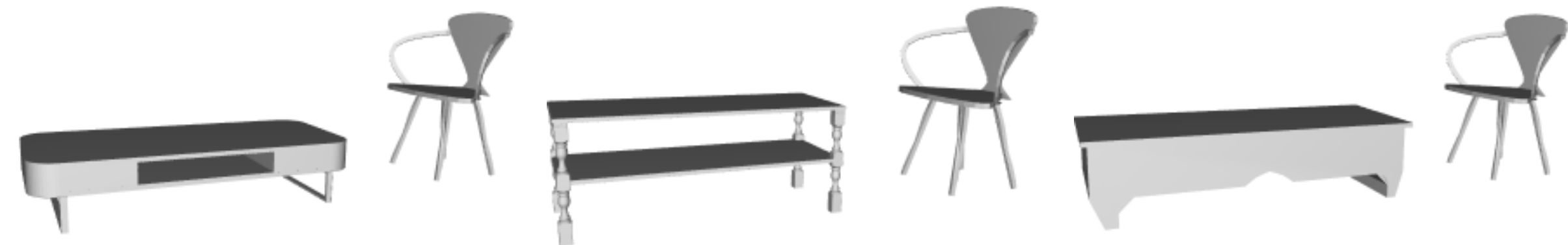

0.461538

0.384615

0.384615

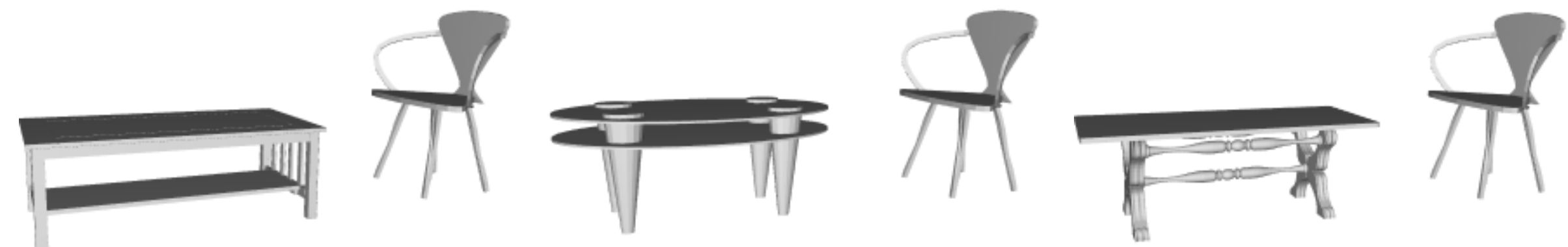

0.307692

0.230769

0.230769

Task 49 of 50 Score = 1.44785



0.461538

0.384615

0.307692



0.307692

0.307692

0.230769

Task 50 of 50 Score = 1.67602



0.421053

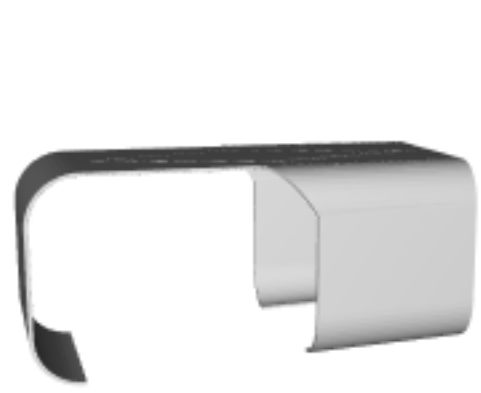

0.421053



0.368421



0.263158

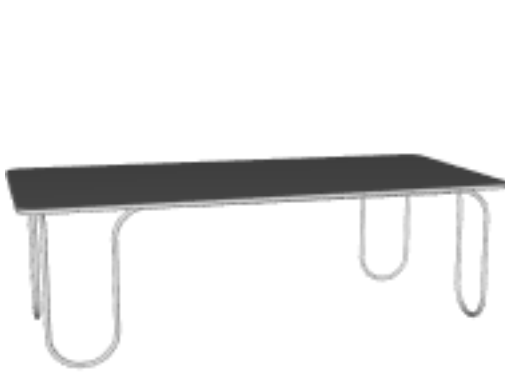

0.263158

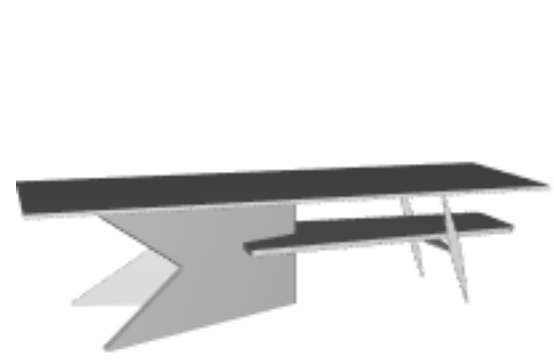

0.263158

