

Task 1 of 50 Score = 2.6901e-05

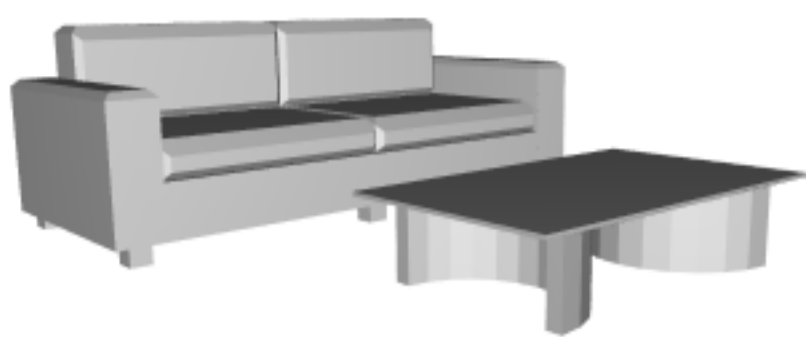

0.882353

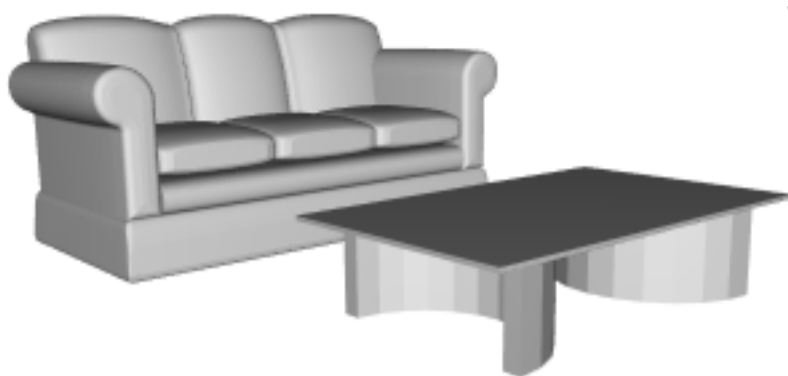

0.470588

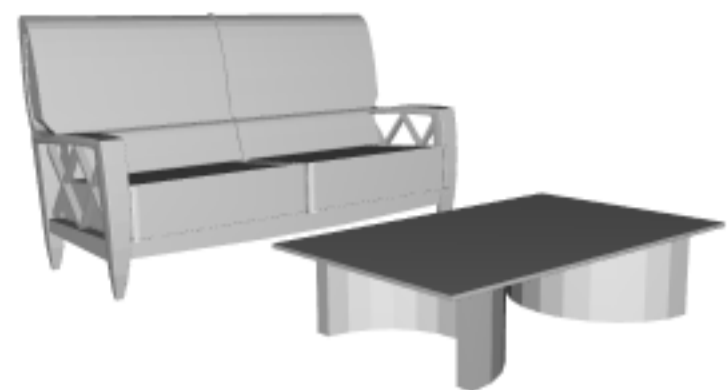

0.235294



0.235294

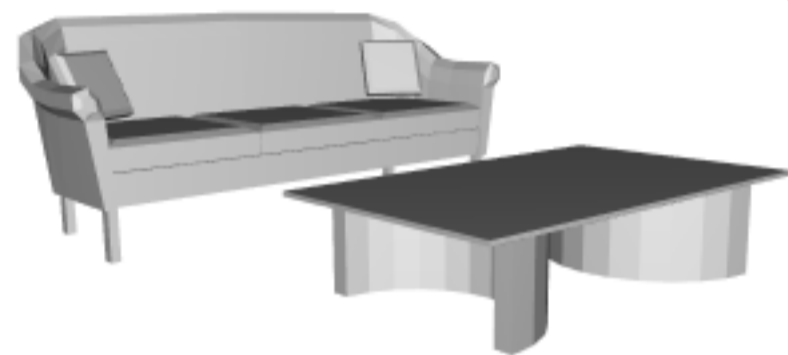

0.176471

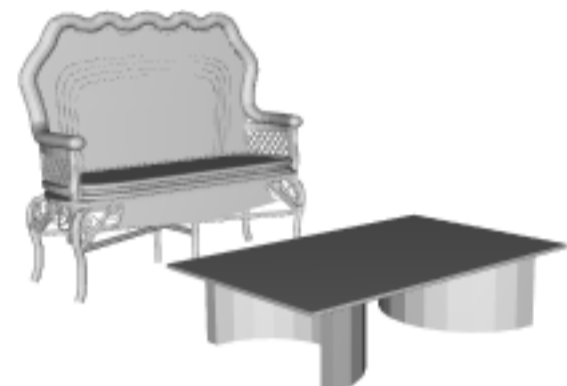

0

Task 2 of 50 Score = 0.00027965

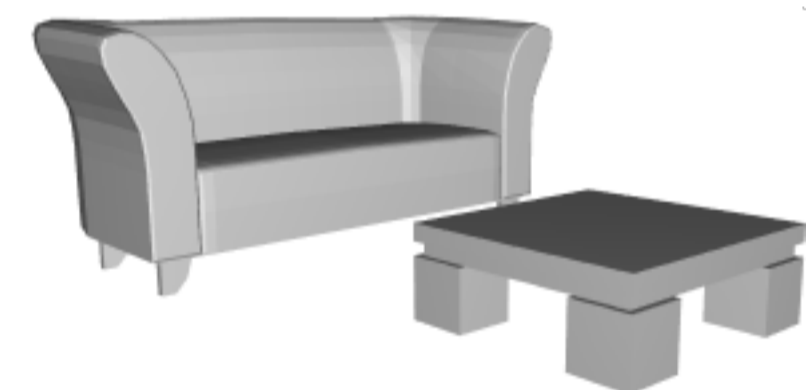

0.823529

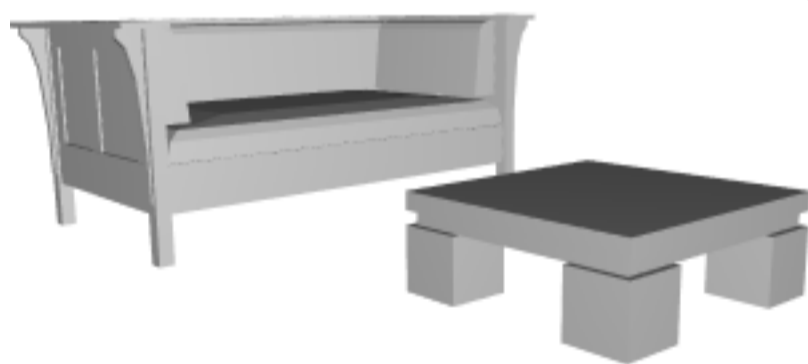

0.529412

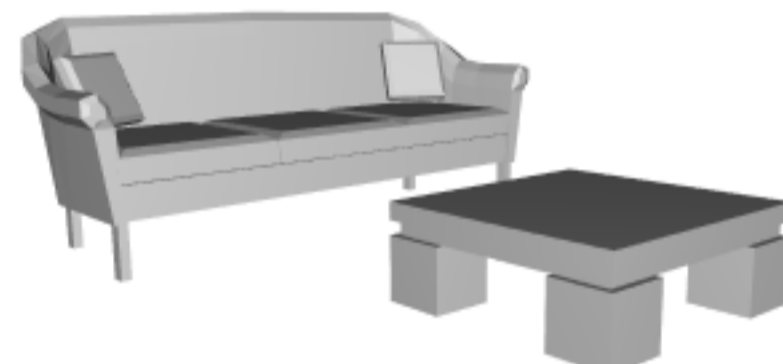

0.470588

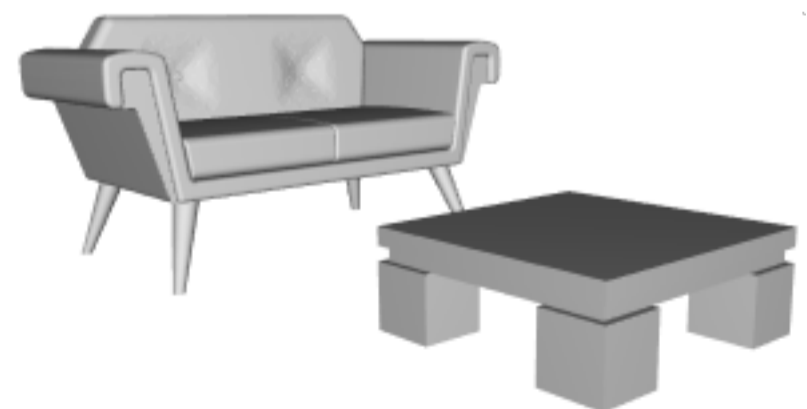

0.117647

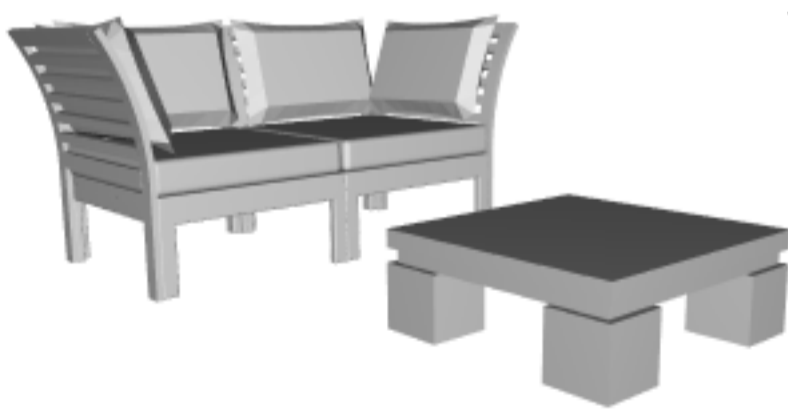

0.0588235

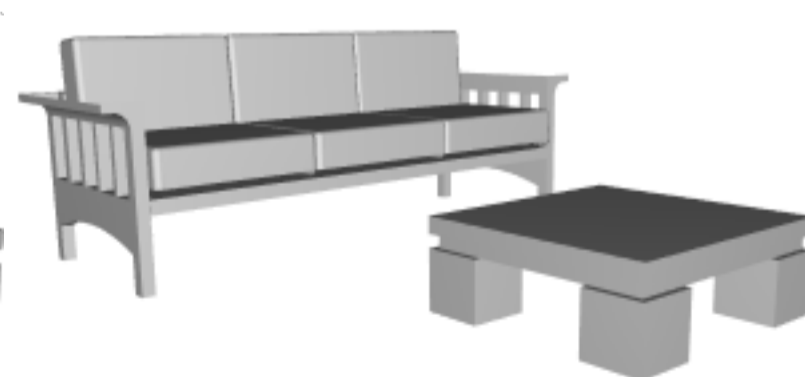

0

Task 3 of 50 Score = 0.00204889

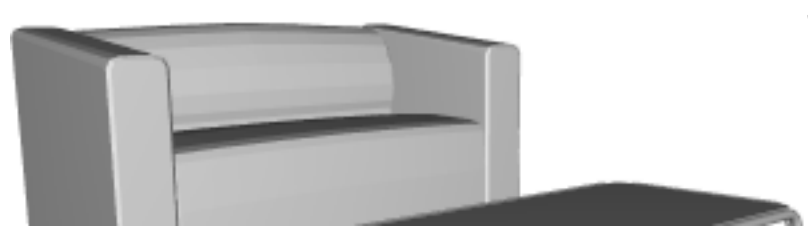



0.764706



0.411765



0.352941



0.294118

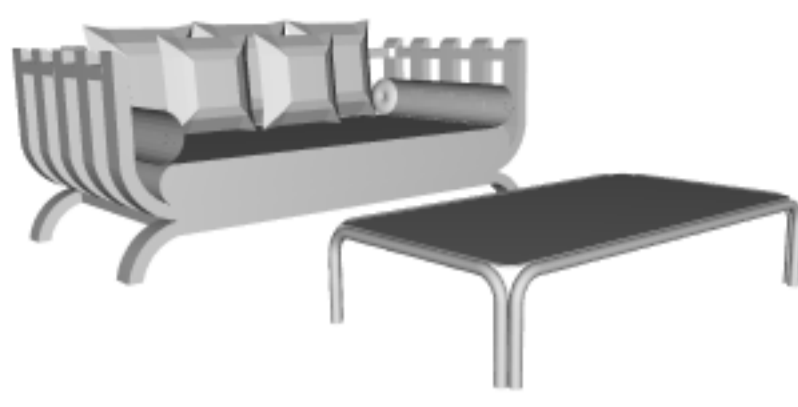

0.176471

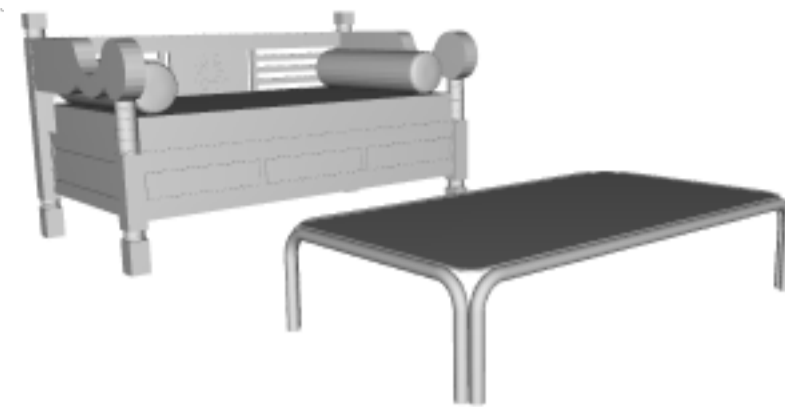

0

Task 4 of 50 Score = 0.00204889



0.764706



0.411765

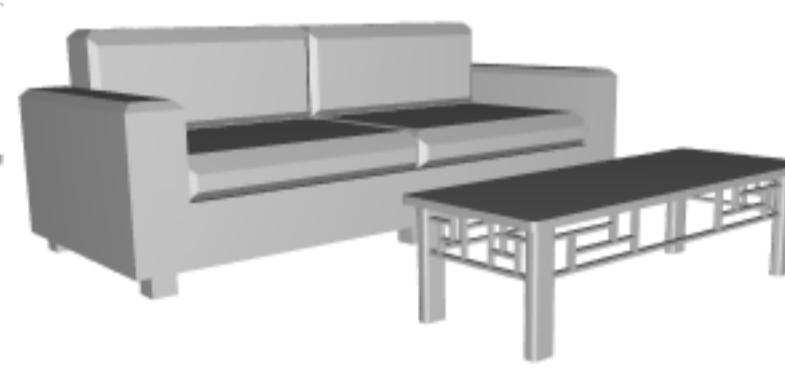

0.352941

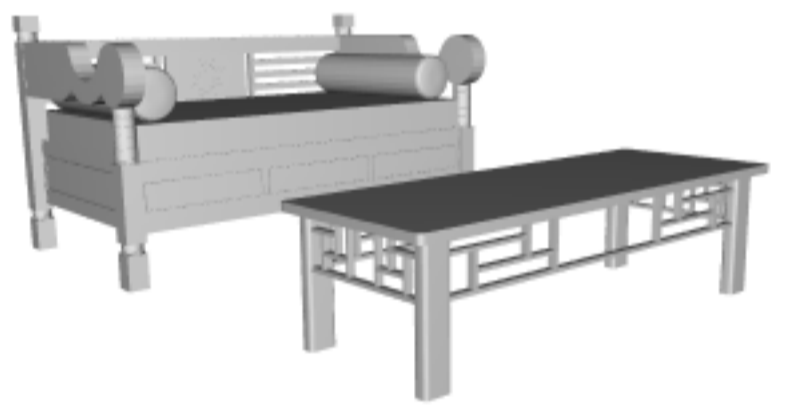

0.235294

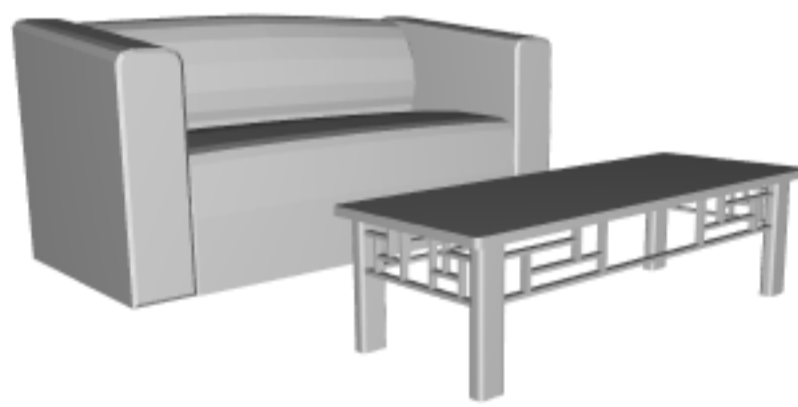

0.176471



0.0588235

Task 5 of 50 Score = 0.0108431

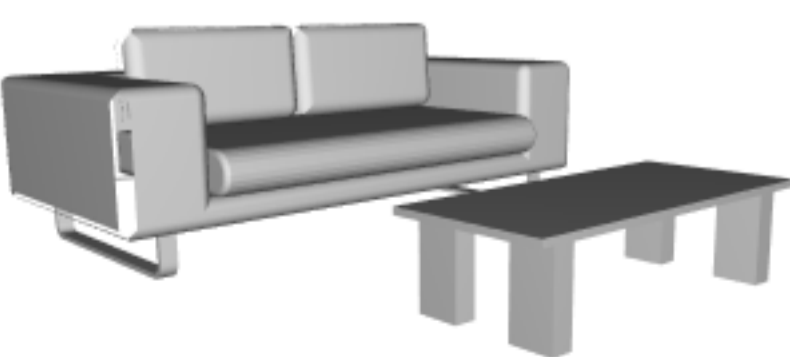

0.733333

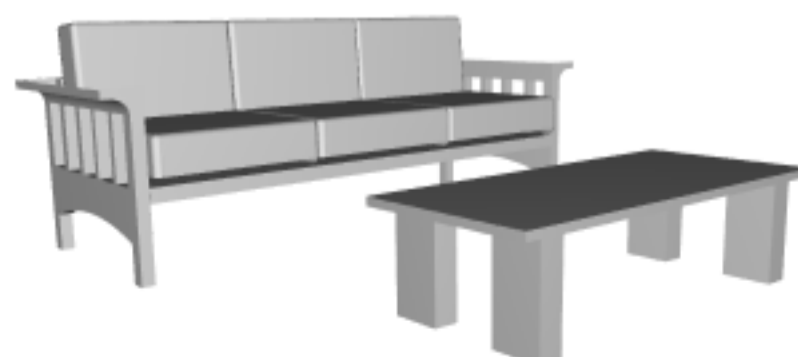

0.466667

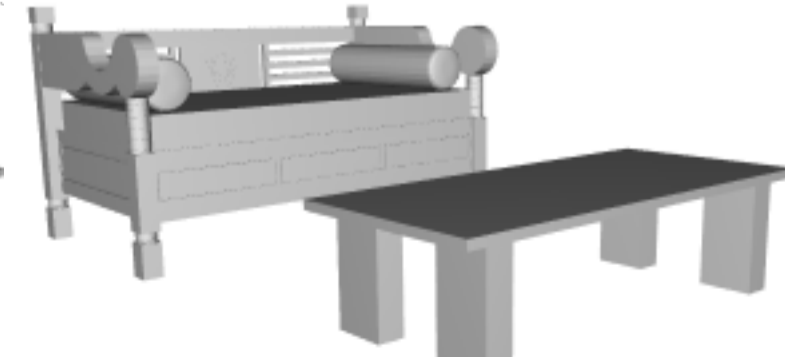

0.333333





0.2



0.2

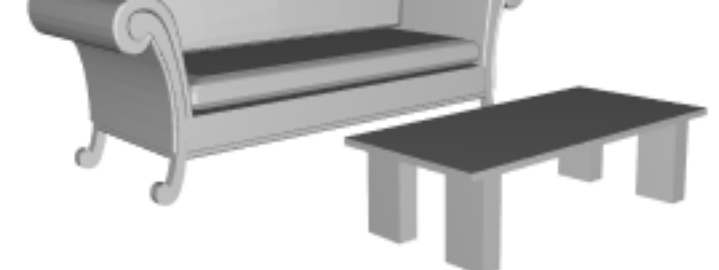

0.0666667

Task 6 of 50 Score = 0.0112489



0.705882



0.470588



0.294118



0.294118

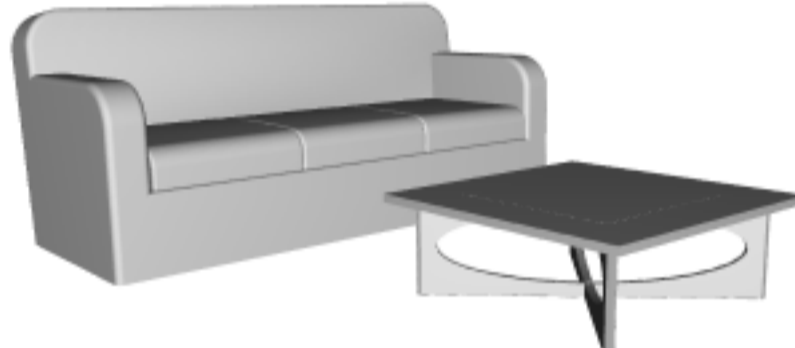

0.235294

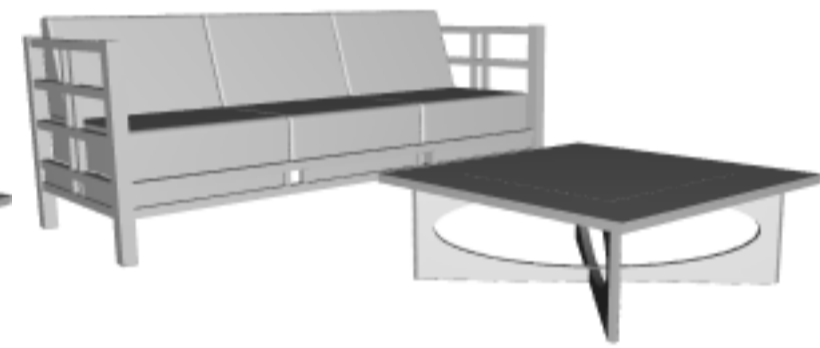

0

Task 7 of 50 Score = 0.0480491

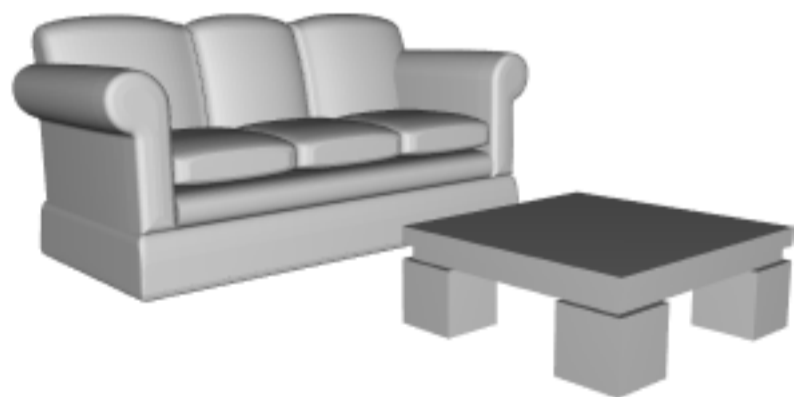

0.647059

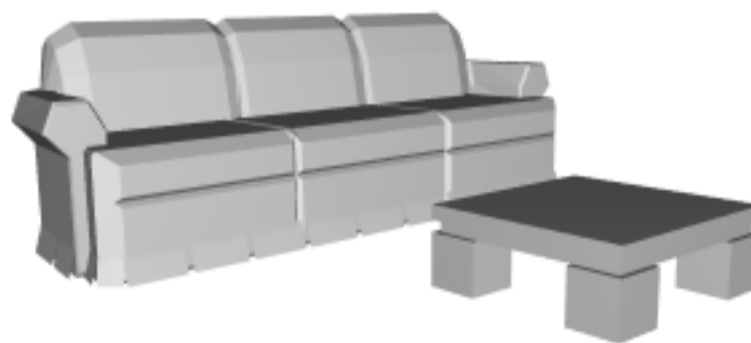

0.647059



0.411765

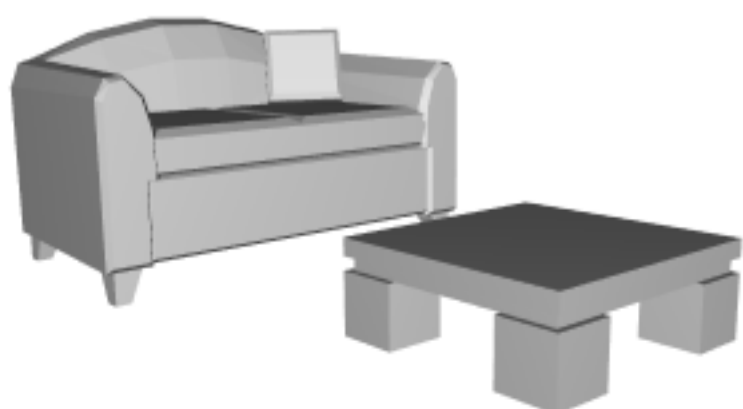

0.176471

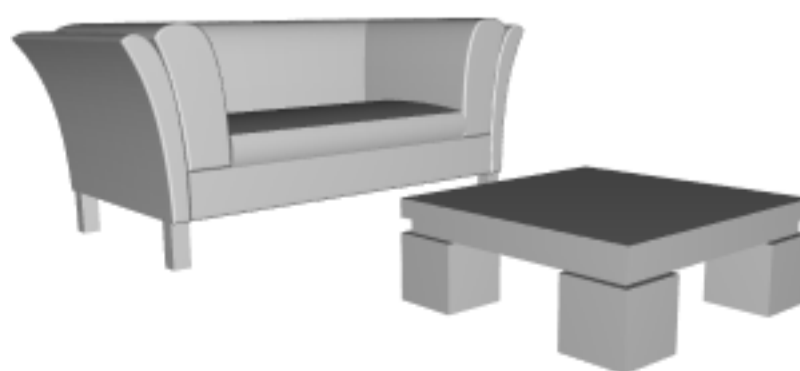

0.117647

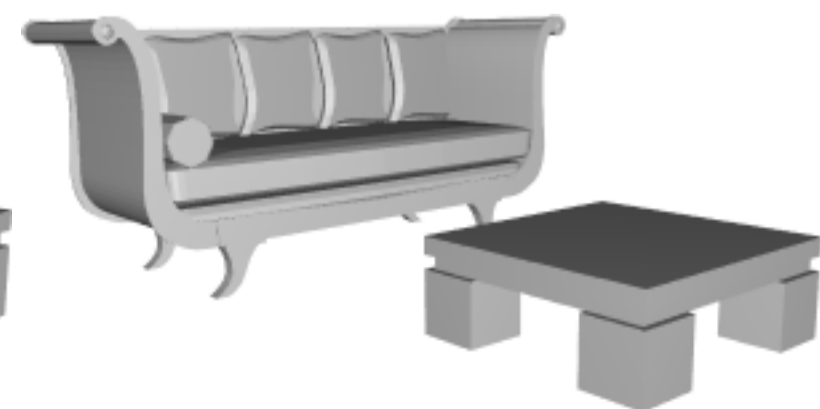

0

Task 8 of 50 Score = 0.0480491



0.647059

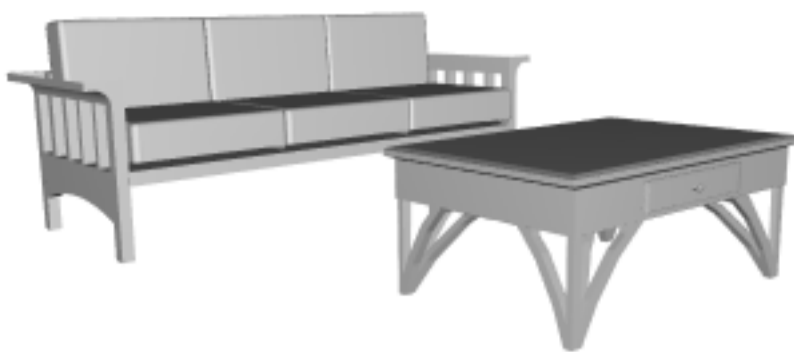

0.470588



0.411765



0.235294

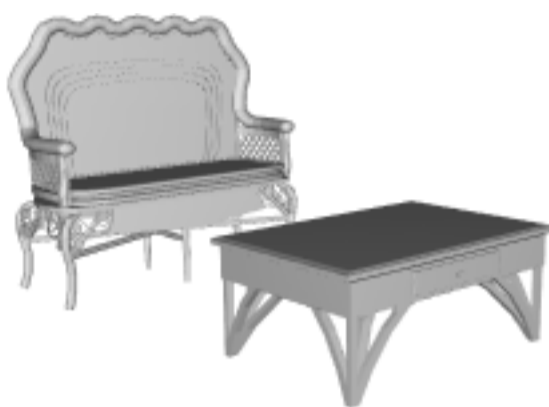

0.117647



0.117647

Task 9 of 50 Score = 0.0480491



0.647059

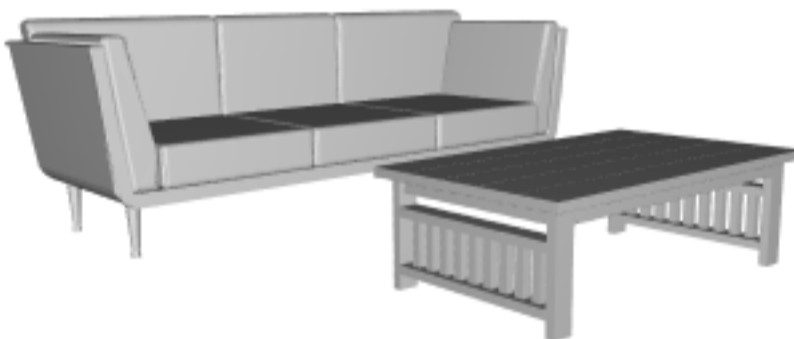

0.588235

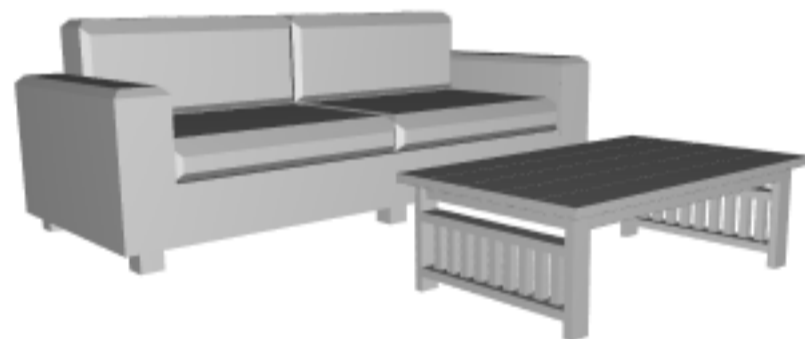

0.352941

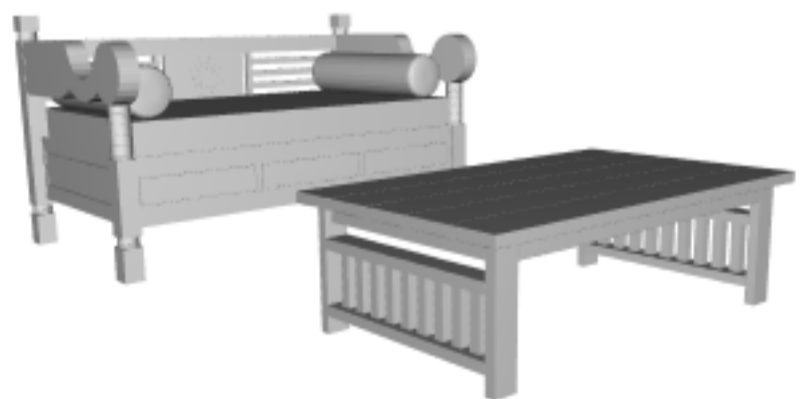

0.294118



0.0588235



0.0588235

Task 10 of 50 Score = 0.0480491

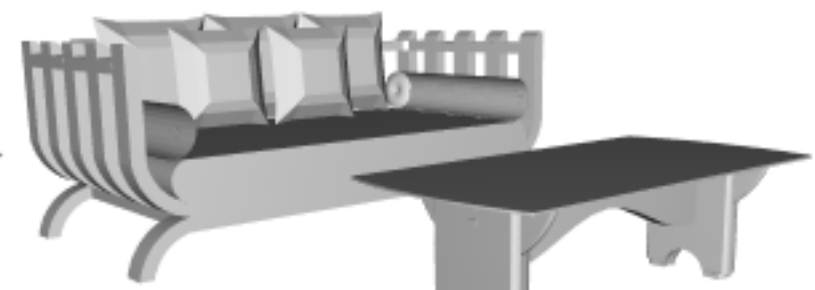
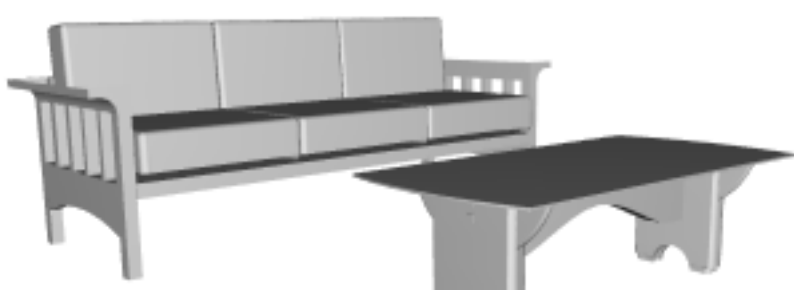
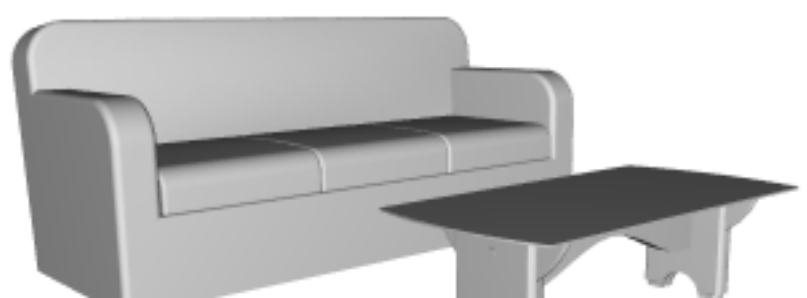

0.647059

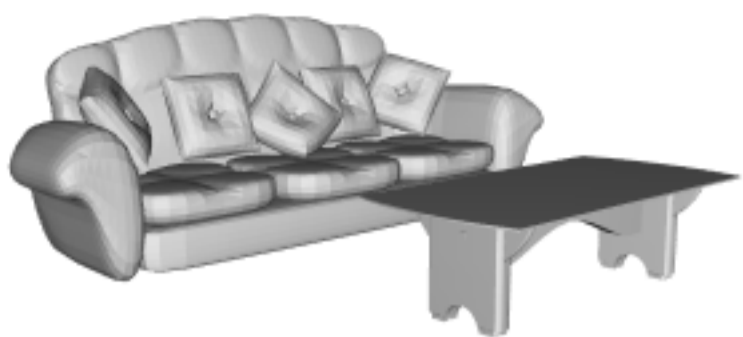

0.470588

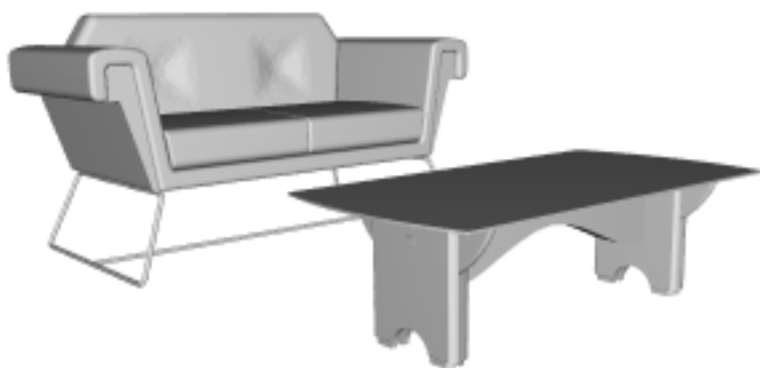

0.411765



0.352941

0.0588235

0.0588235

Task 11 of 50 Score = 0.0480491

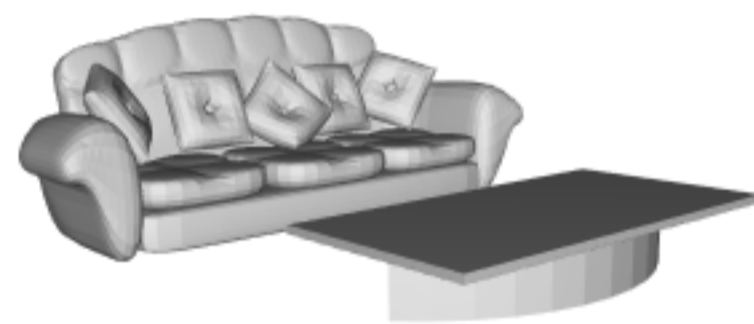
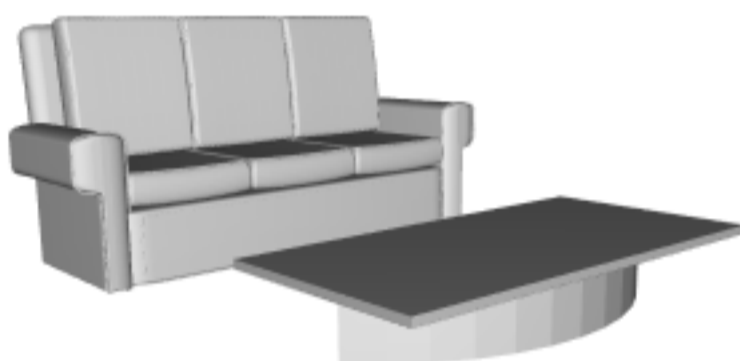

0.647059

0.529412

0.352941

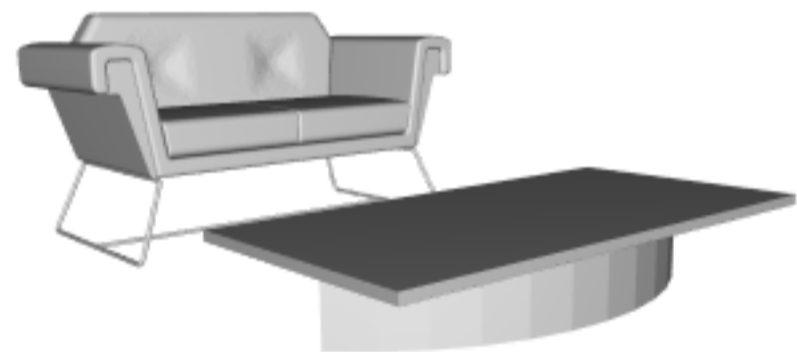
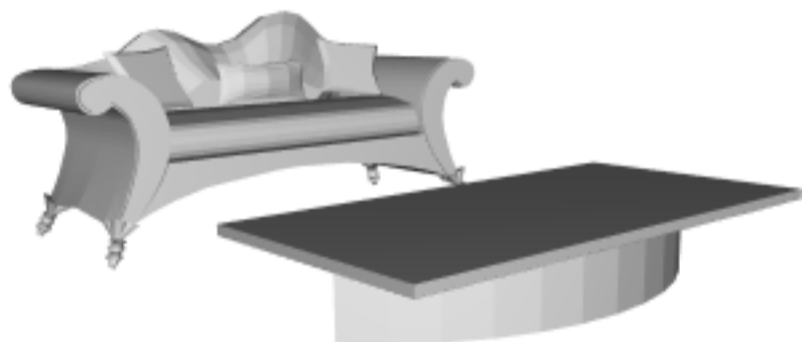

0.176471

0.176471

0.117647

Task 12 of 50 Score = 0.0510256

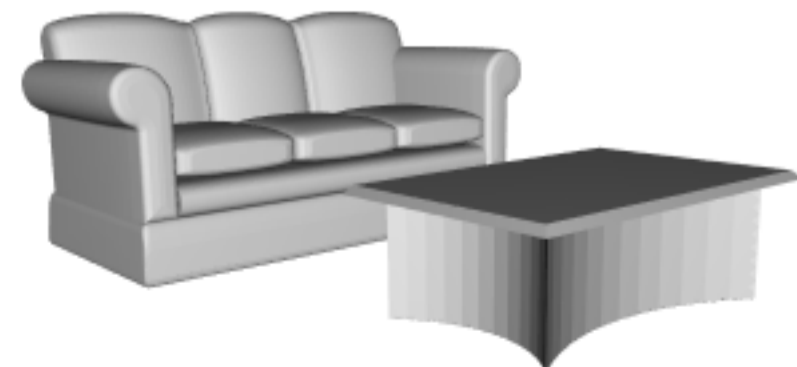
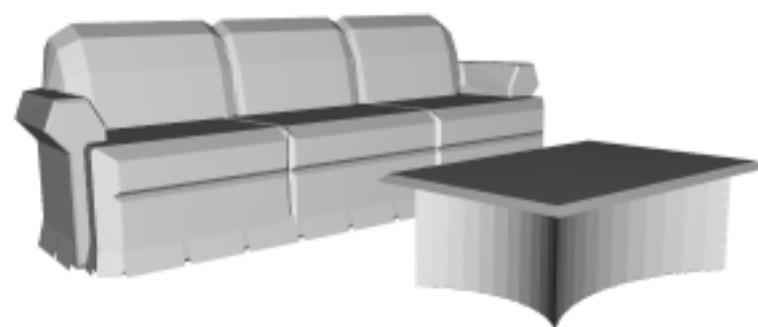
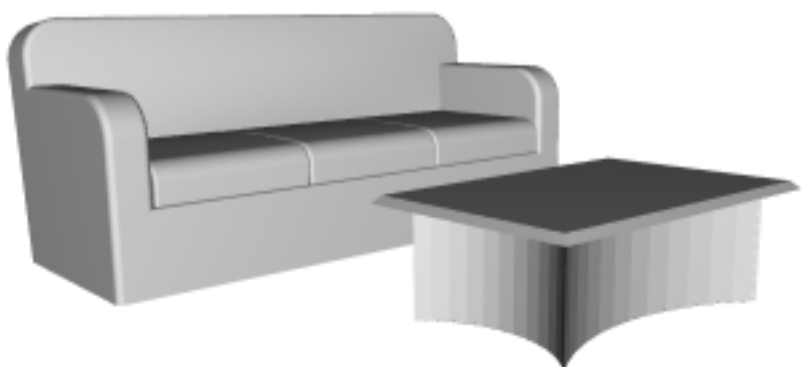

0.666667

0.6

0.466667

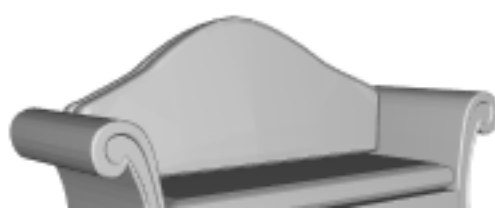
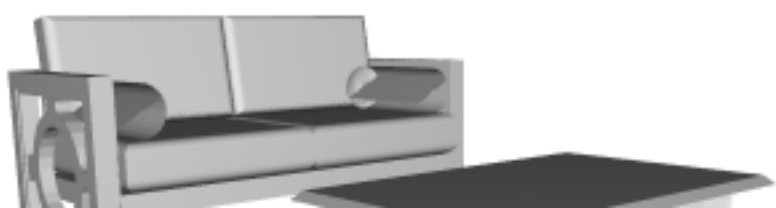

0.2

0.0666667

0

Task 13 of 50 Score = 0.0510256



0.666667



0.333333

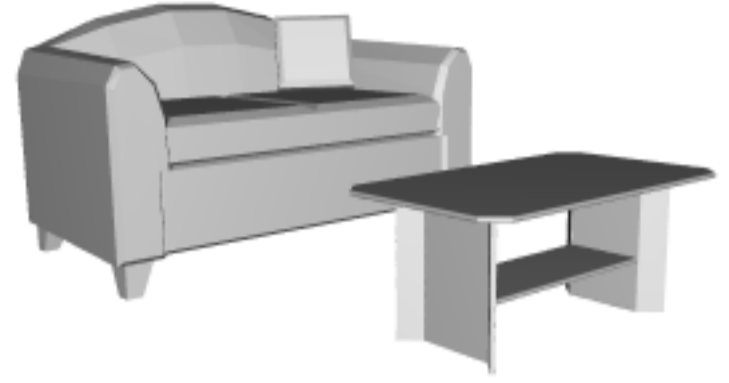

0.333333

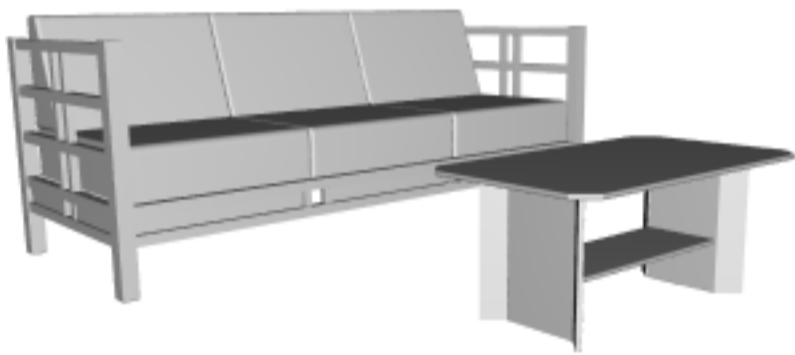

0.333333

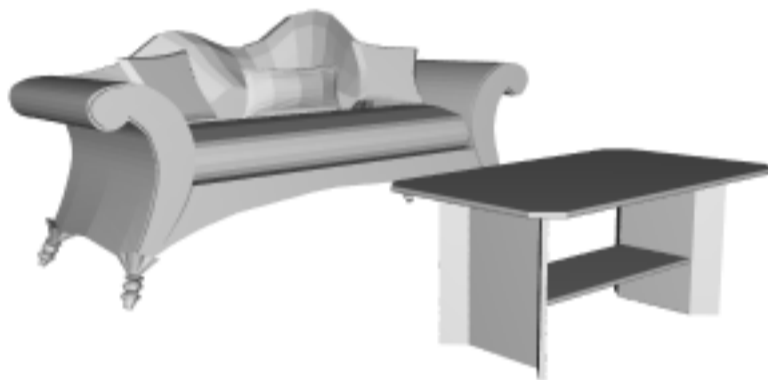

0.2



0.133333

Task 14 of 50 Score = 0.0510256

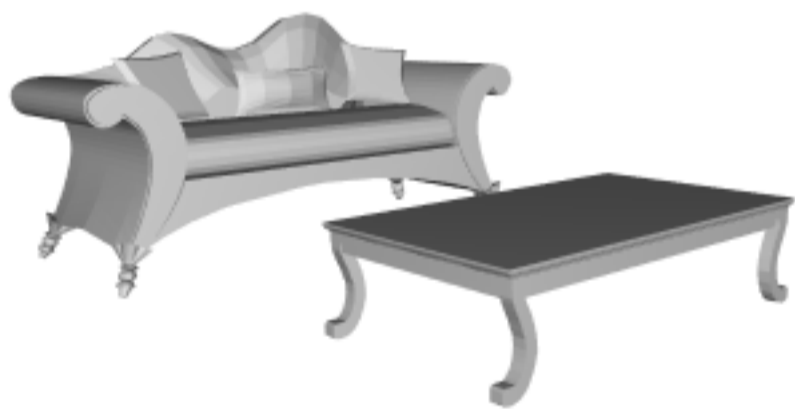

0.666667



0.4



0.333333



0.333333

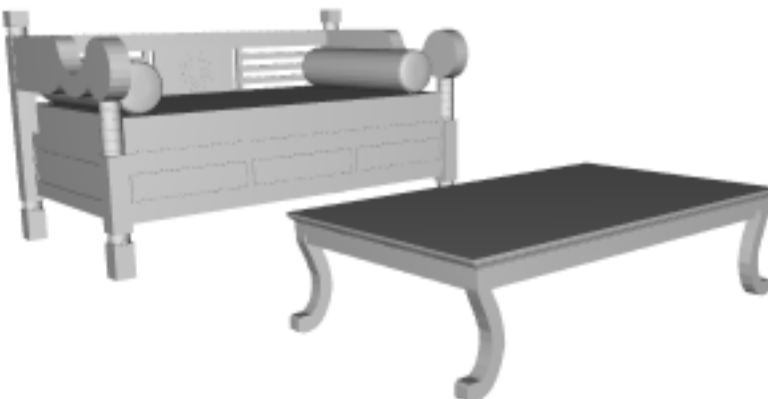

0.133333



0.133333

Task 15 of 50 Score = 0.0510256



0.666667



0.466667



0.333333



0.266667



0.2



0.0666667

Task 16 of 50 Score = 0.163707



0.588235

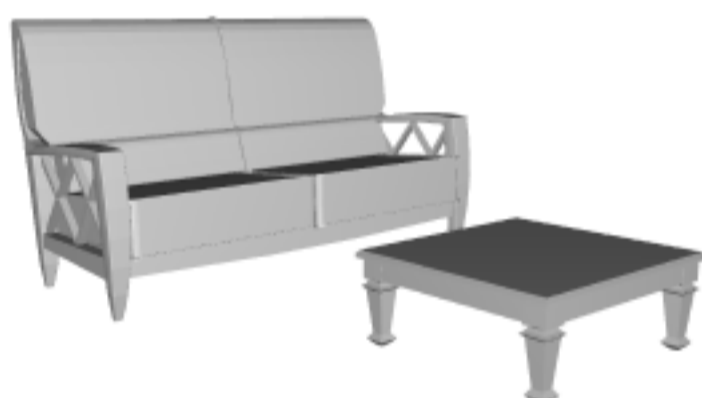

0.529412

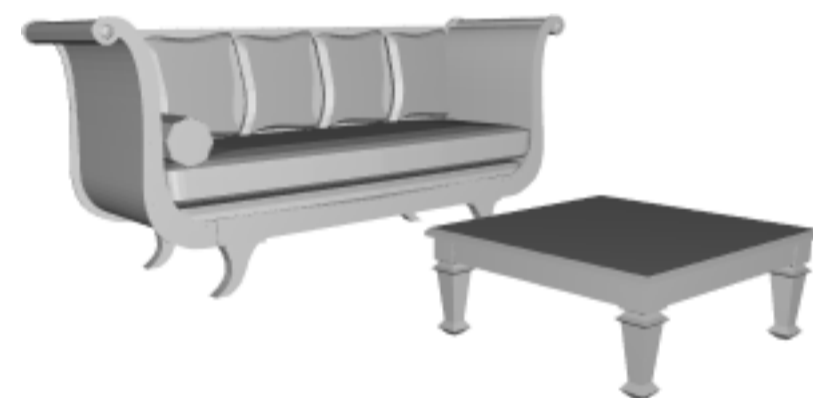

0.352941



0.235294



0.176471



0.117647

Task 17 of 50 Score = 0.163707

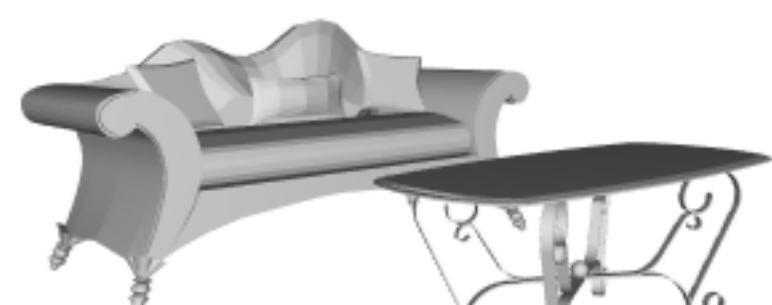

0.588235



0.352941

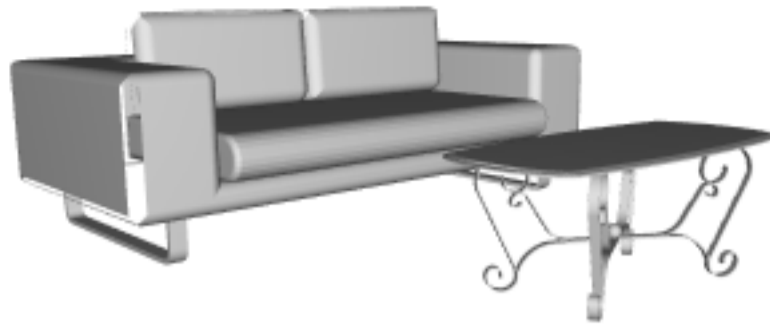

0.352941

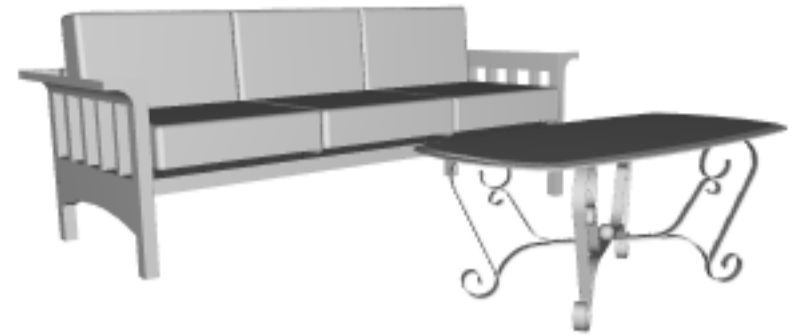

0.294118

0.235294

0.176471

Task 18 of 50 Score = 0.163707



0.588235

0.529412

0.352941

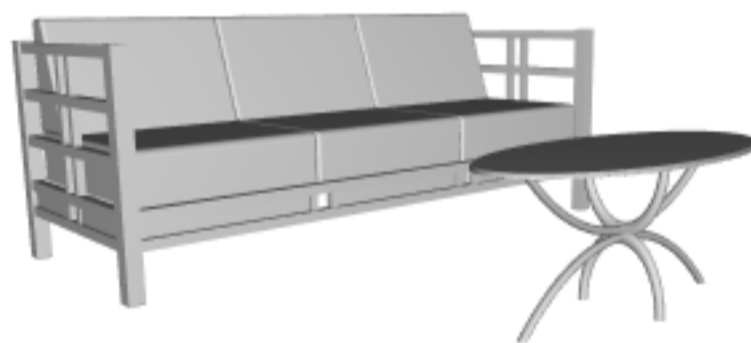

0.235294

0.176471

0.117647

Task 19 of 50 Score = 0.163707



0.588235

0.529412

0.352941

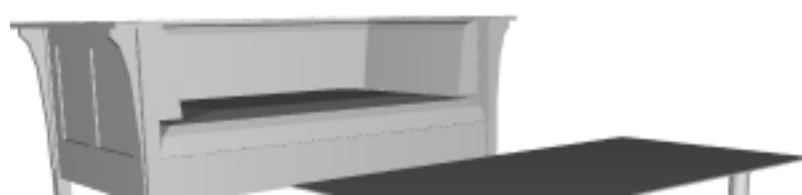
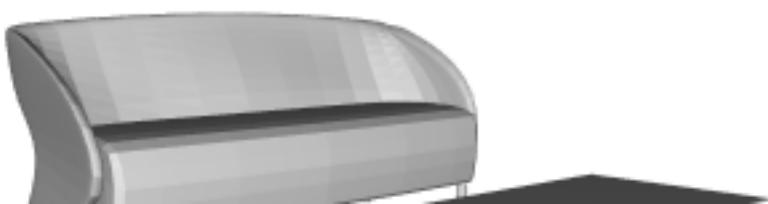
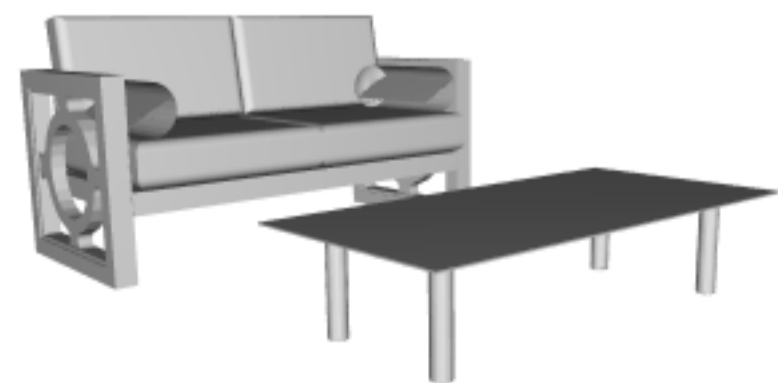
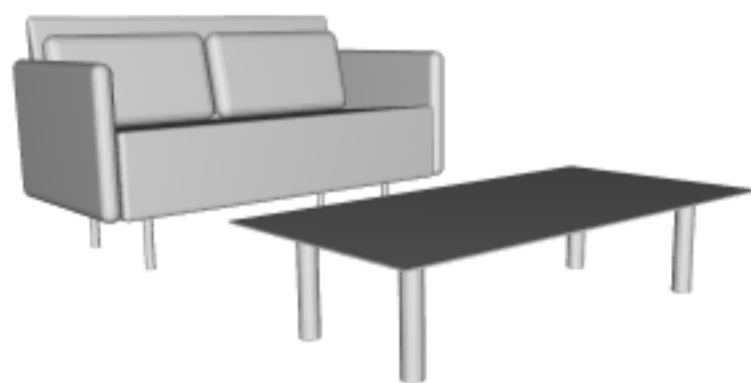



0.235294

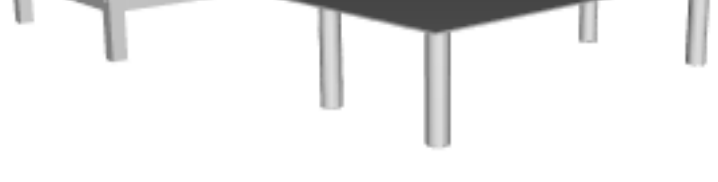

0.235294



0.0588235

Task 20 of 50 Score = 0.163707

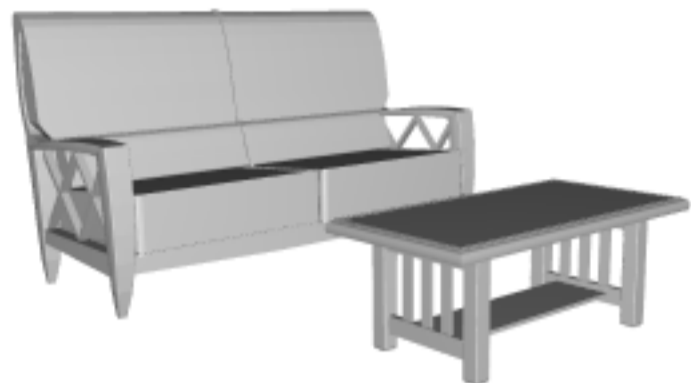

0.588235



0.529412



0.411765



0.176471



0.176471



0.117647

Task 21 of 50 Score = 0.184968



0.6

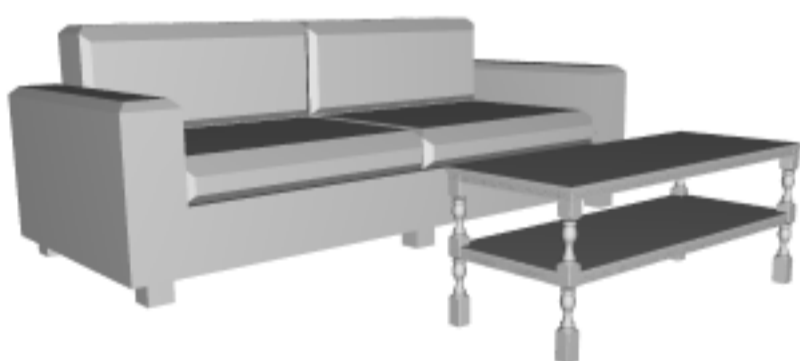

0.533333



0.333333

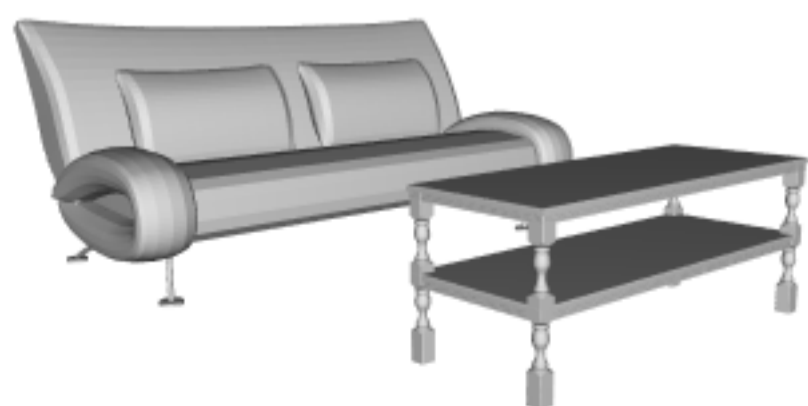

0.2

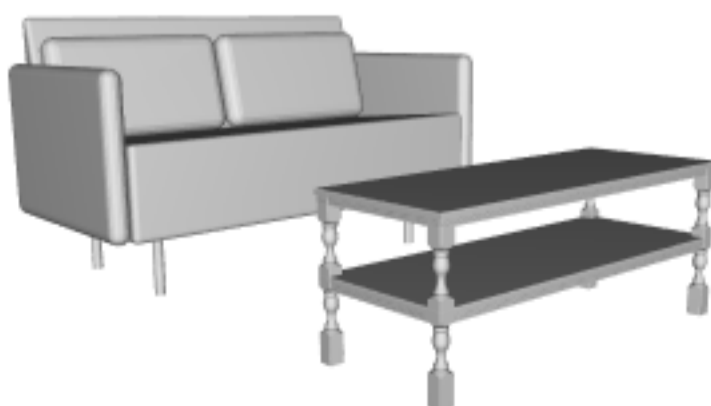

0.2

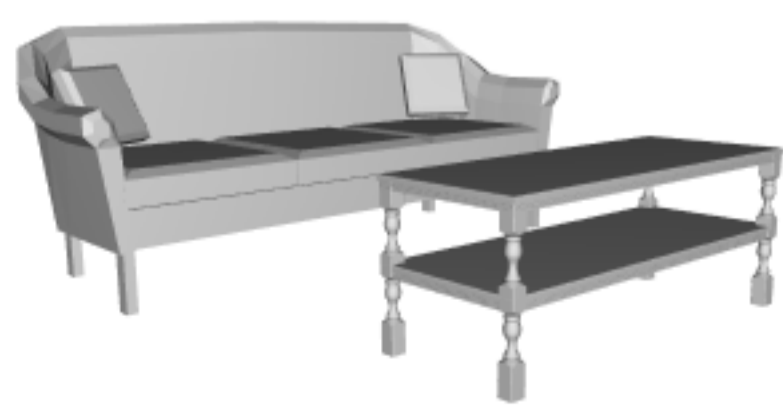

0.133333

Task 22 of 50 Score = 0.184968



0.6



0.466667



0.333333



0.266667

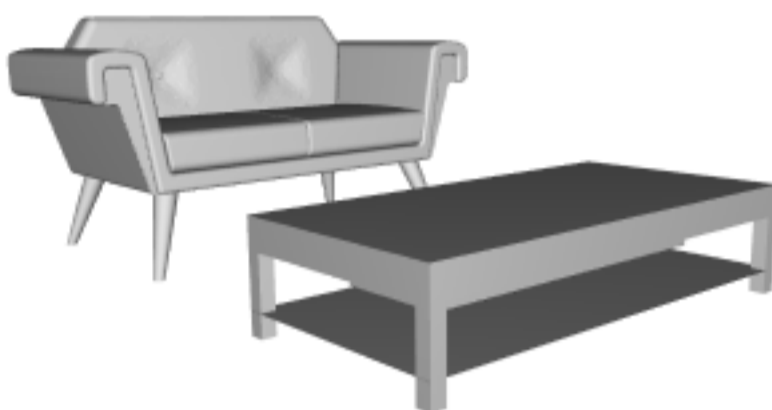

0.266667

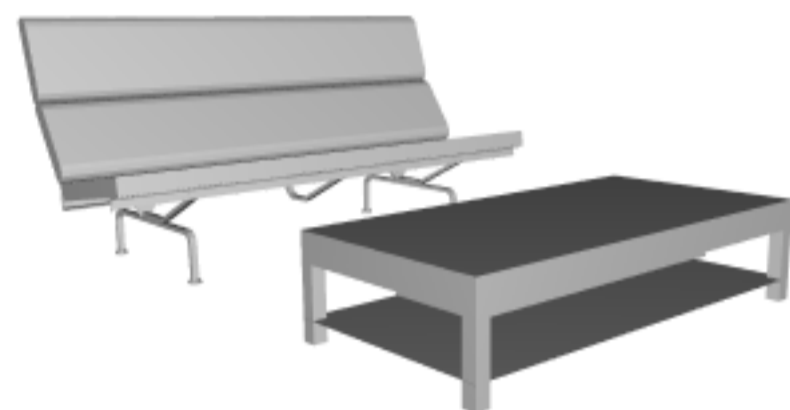

0.0666667

Task 23 of 50 Score = 0.184968



0.6

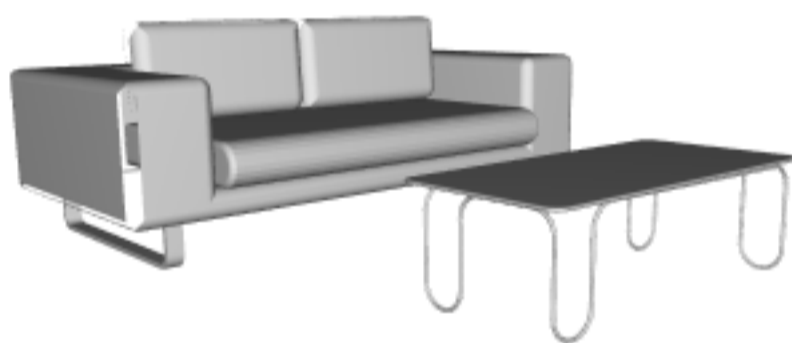

0.466667



0.4



0.266667



0.133333

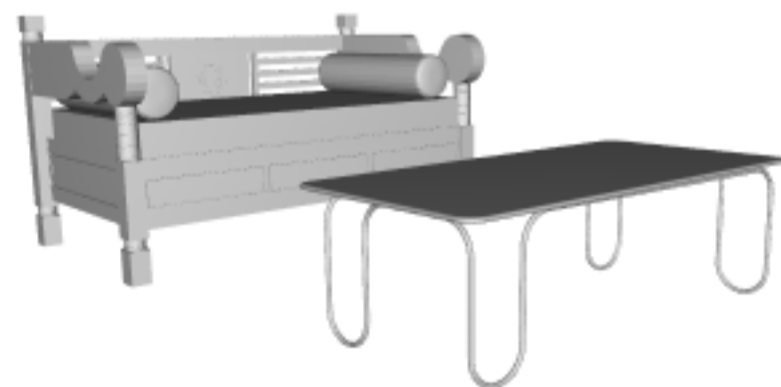

0.133333

Task 24 of 50 Score = 0.184968

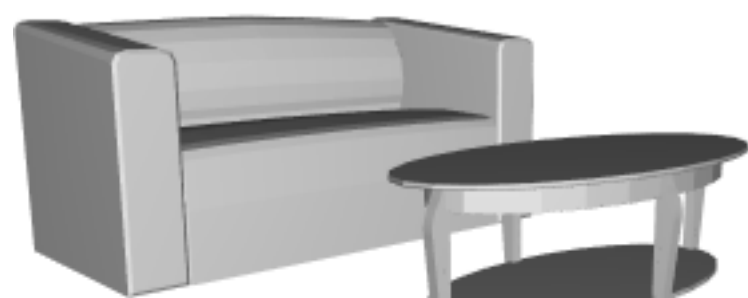

0.6



0.533333

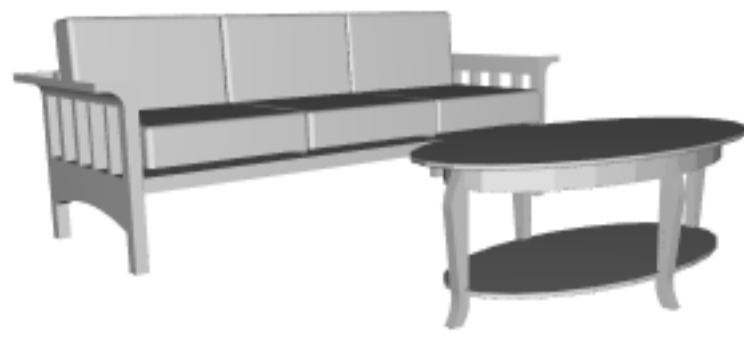

0.466667



0.2

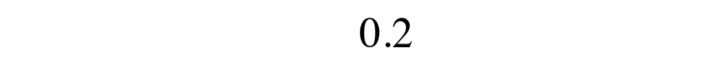

0.133333

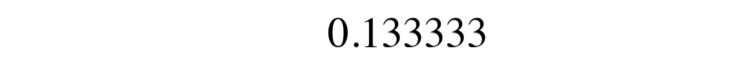

0.0666667

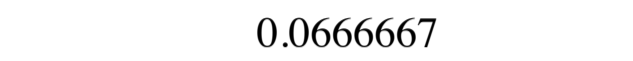

Task 25 of 50 Score = 0.184968

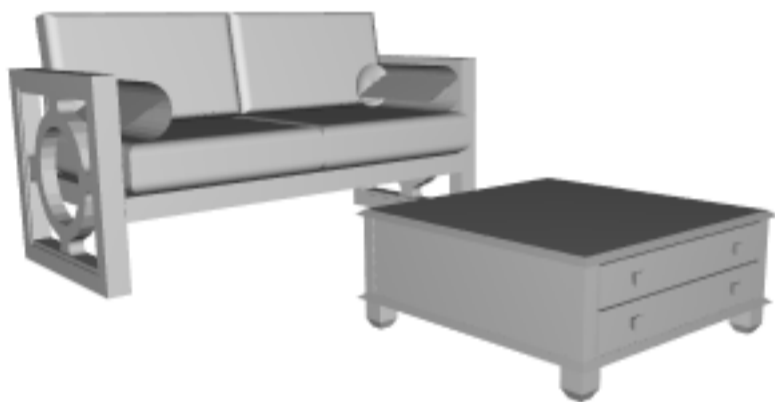

0.6



0.533333



0.333333



0.333333



0.2



0

Task 26 of 50 Score = 0.184968



0.6



0.533333



0.466667

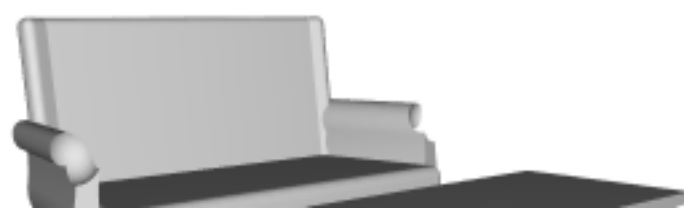
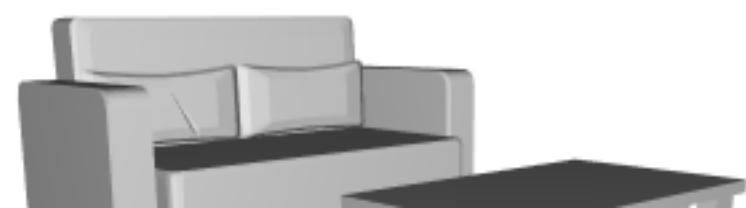



0.266667



0.0666667



0.0666667

Task 27 of 50 Score = 0.184968



0.6

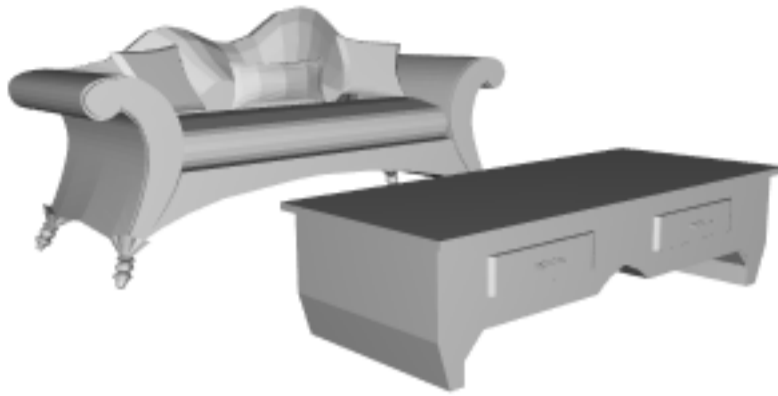

0.466667

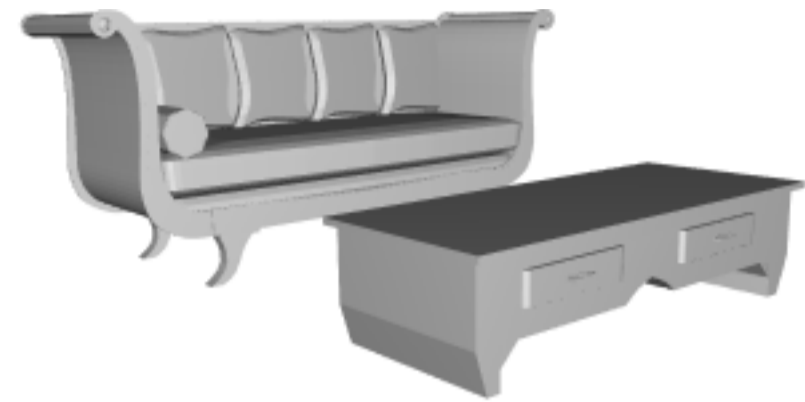

0.4

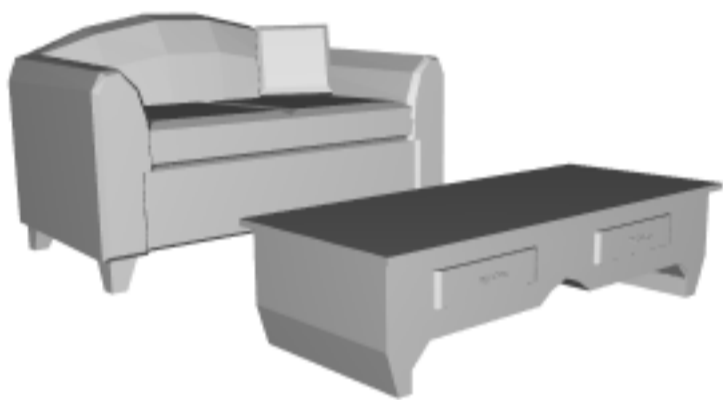

0.266667

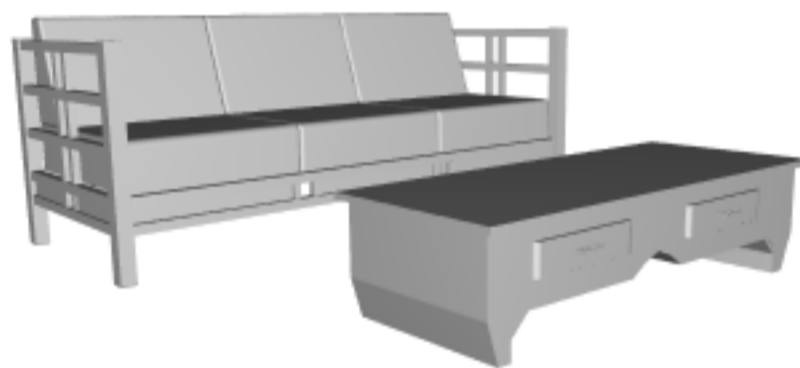

0.266667

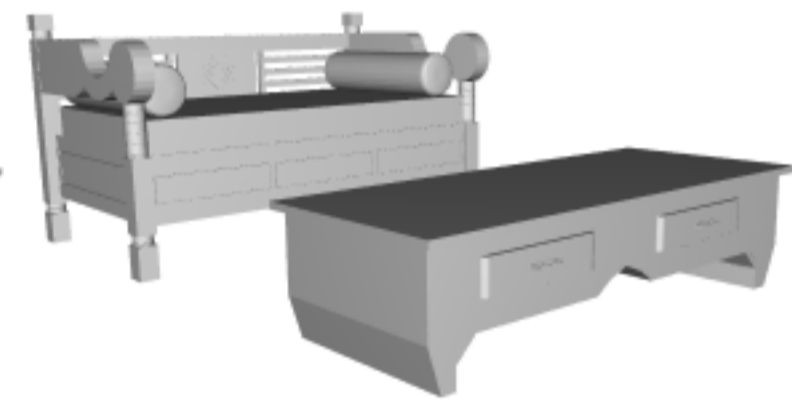

0

Task 28 of 50 Score = 0.184968



0.6



0.466667



0.333333



0.266667



0.2



0.133333

Task 29 of 50 Score = 0.452851



0.529412



0.470588

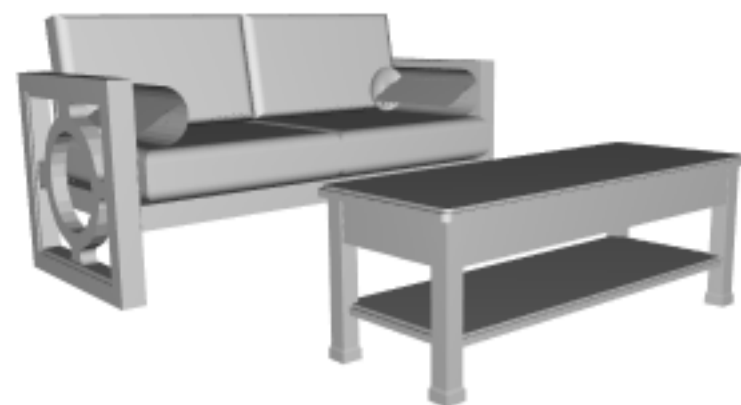

0.352941



0.294118



0.235294

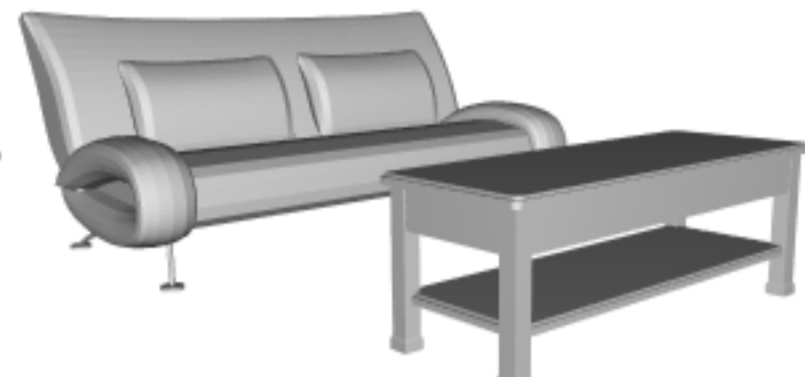

0.117647

Task 30 of 50 Score = 0.452851

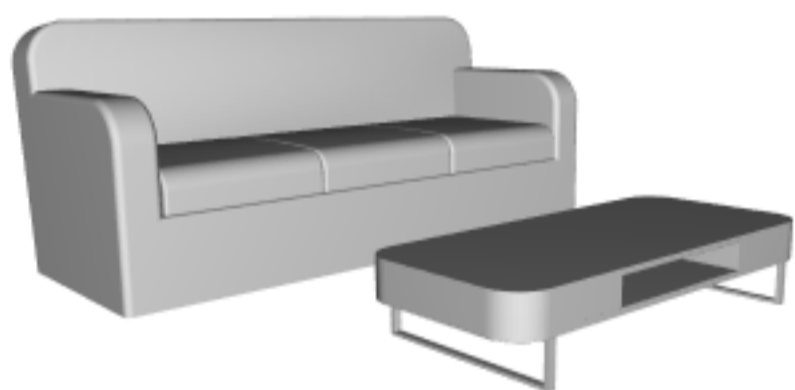

0.529412



0.529412

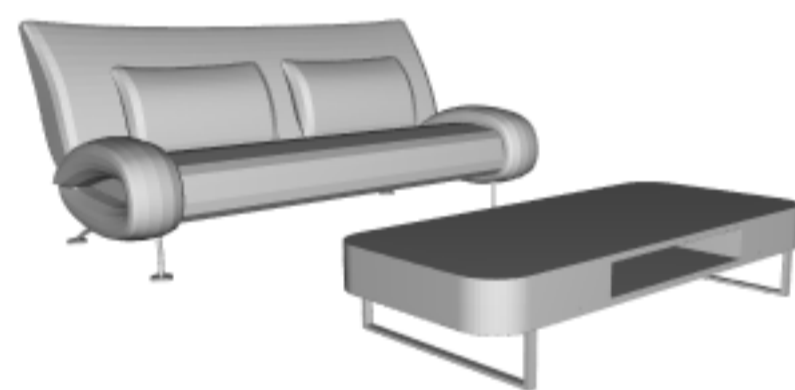

0.352941

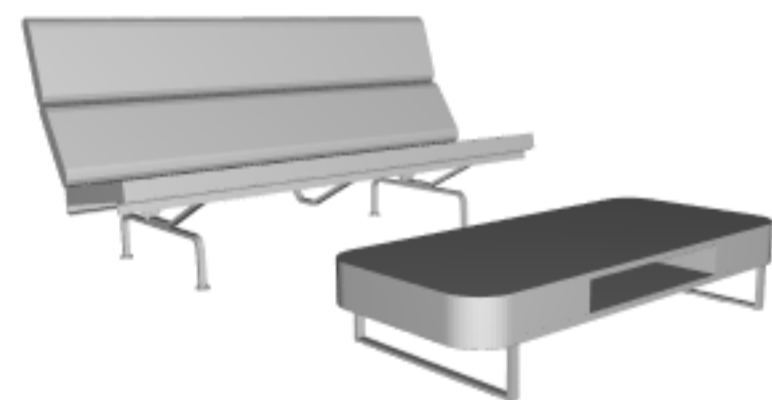

0.352941

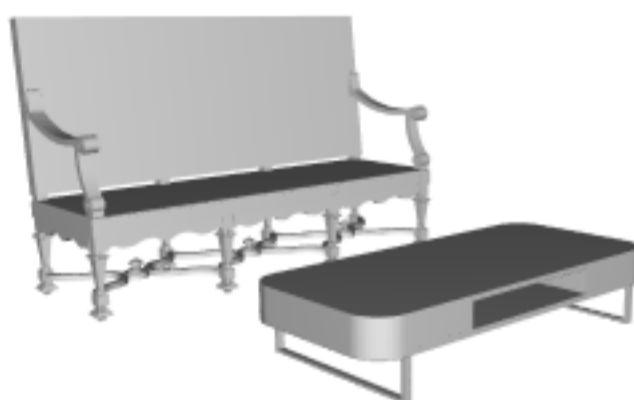

0.235294



0

Task 31 of 50 Score = 0.452851

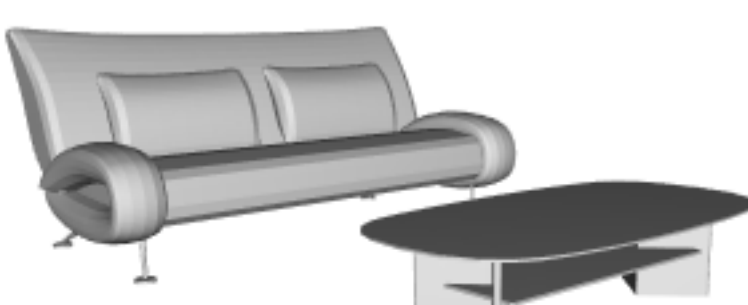
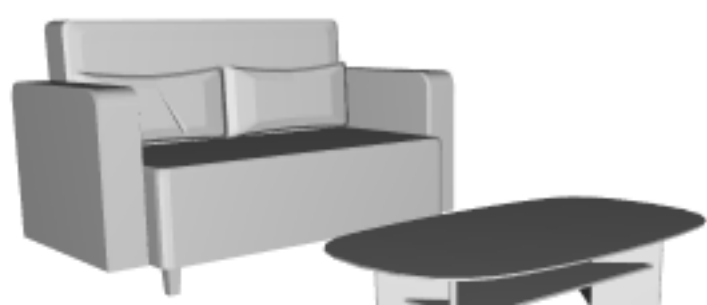

0.529412

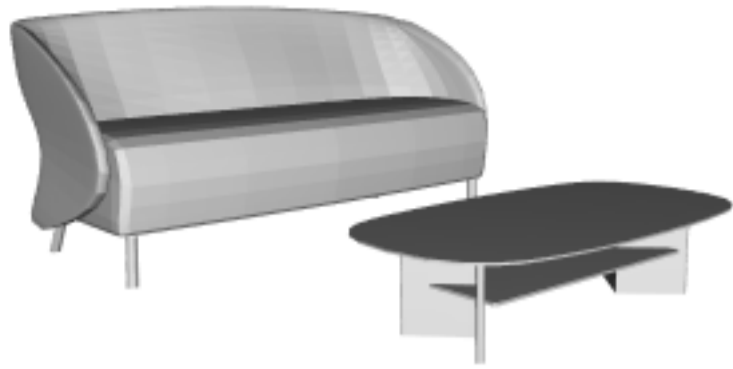

0.470588

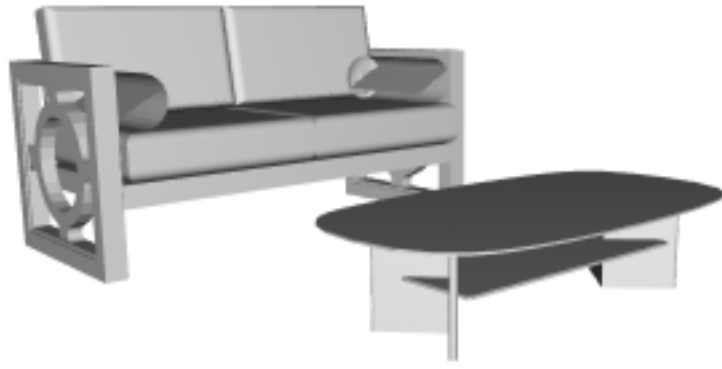

0.470588



0.352941

0.117647

0.0588235

Task 32 of 50 Score = 0.452851



0.529412



0.529412



0.352941



0.294118

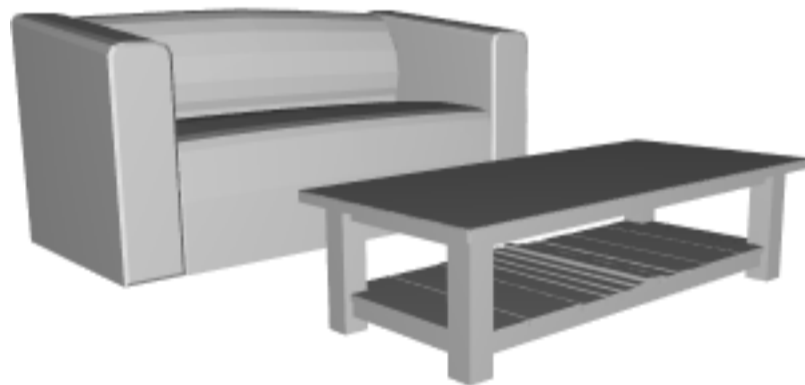

0.235294

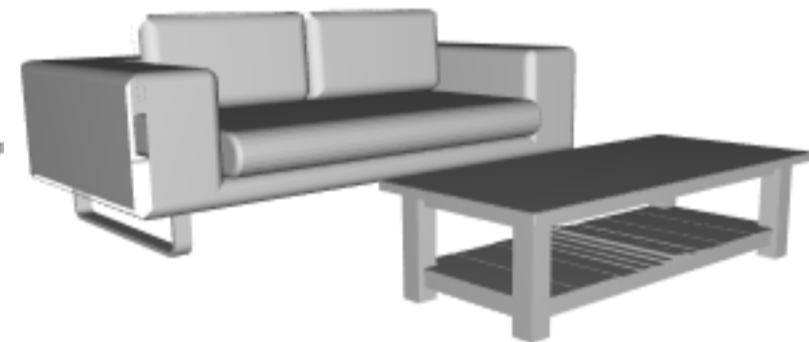

0.0588235

Task 33 of 50 Score = 0.452851

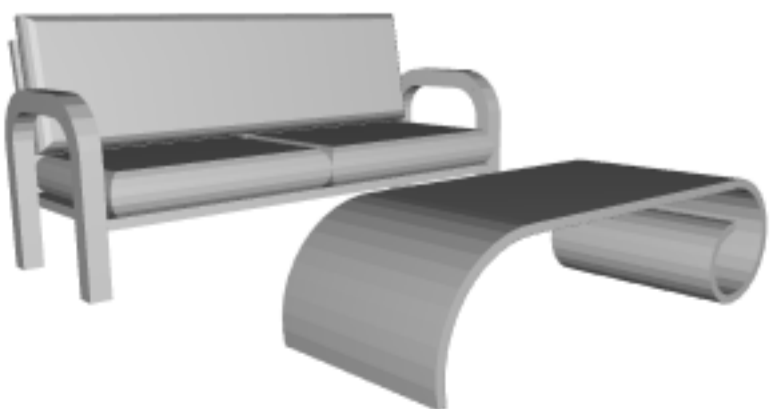

0.529412

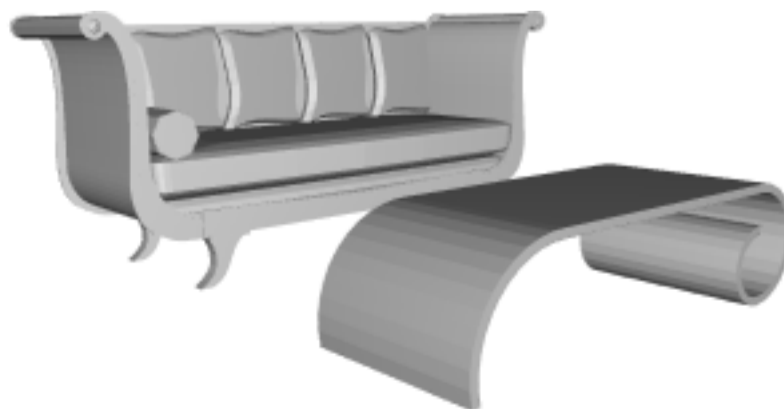

0.470588

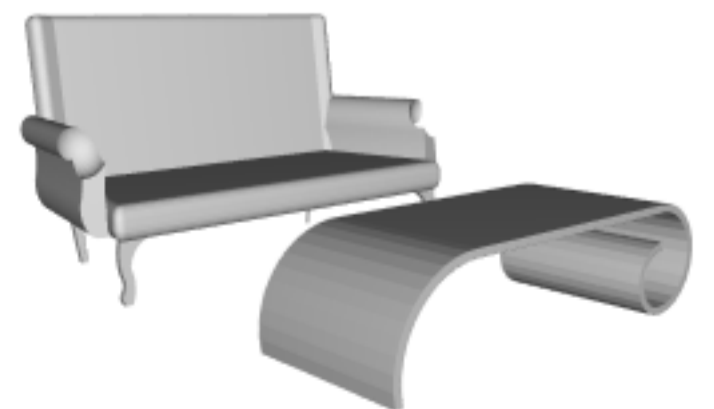

0.352941

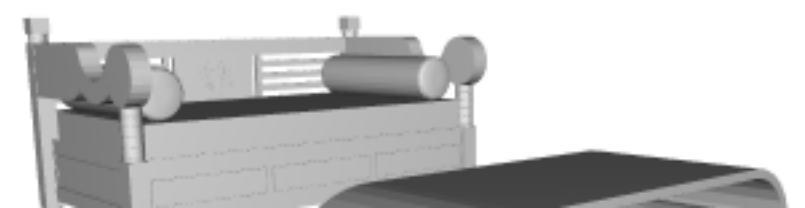
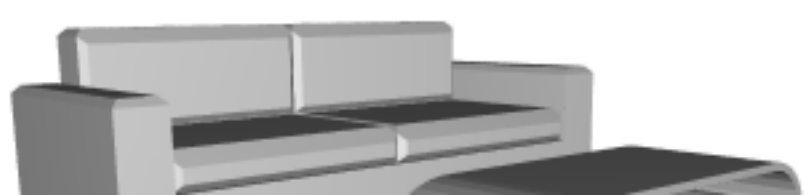



0.294118

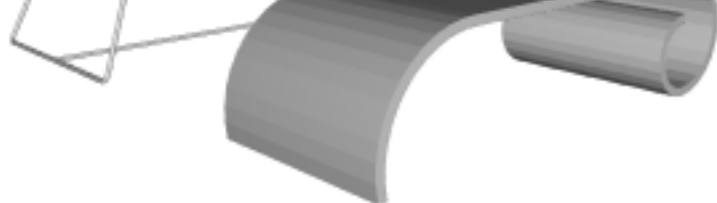

0.294118

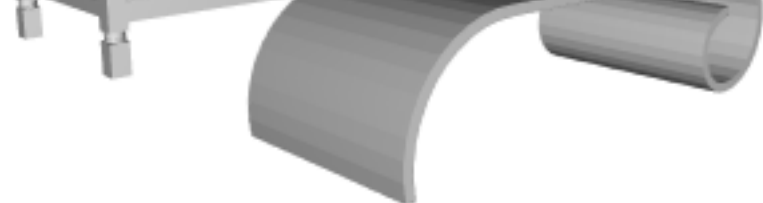

0.0588235

Task 34 of 50 Score = 0.452851



0.529412



0.470588



0.411765



0.352941



0.176471



0.0588235

Task 35 of 50 Score = 0.452851

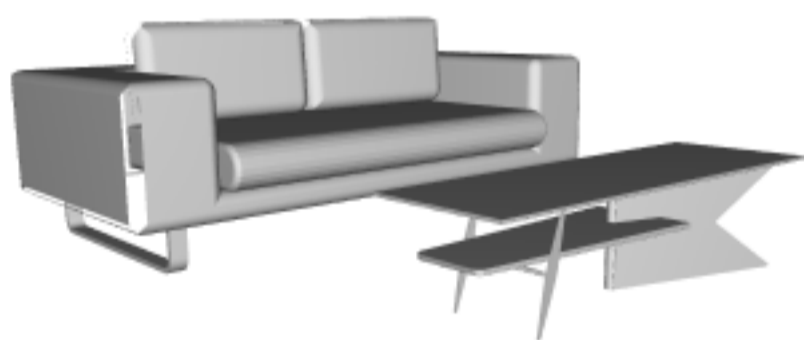

0.529412

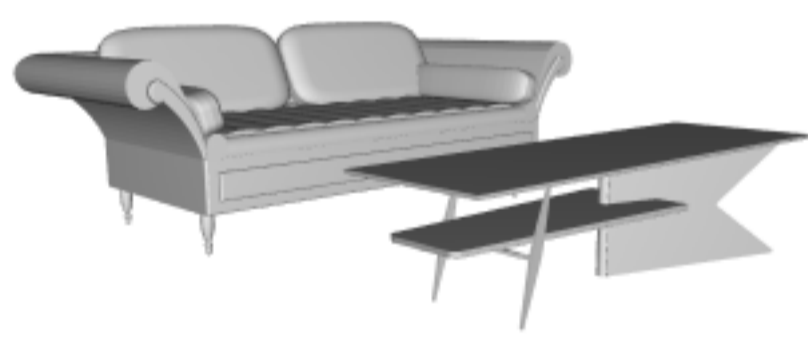

0.529412



0.352941

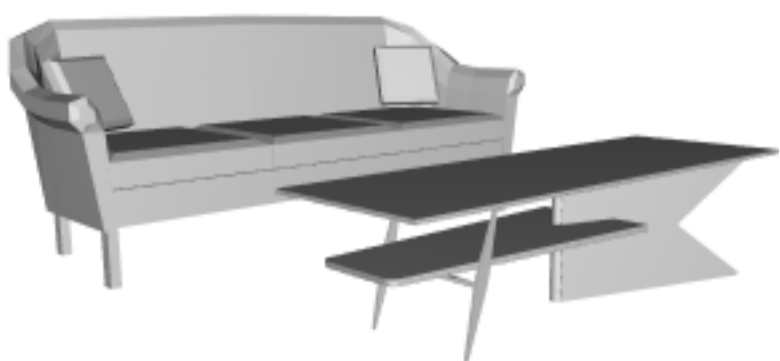

0.294118

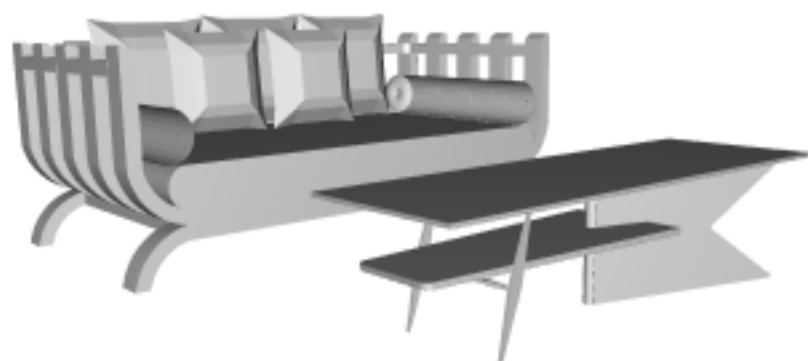

0.294118

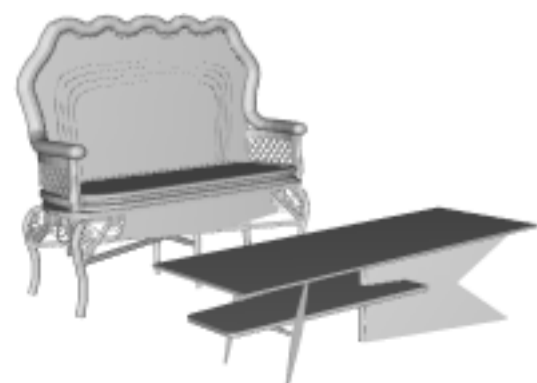

0

Task 36 of 50 Score = 0.52939



0.533333

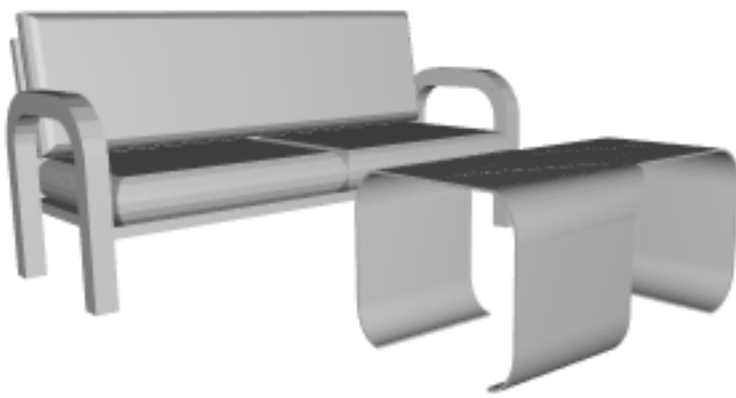

0.533333



0.533333

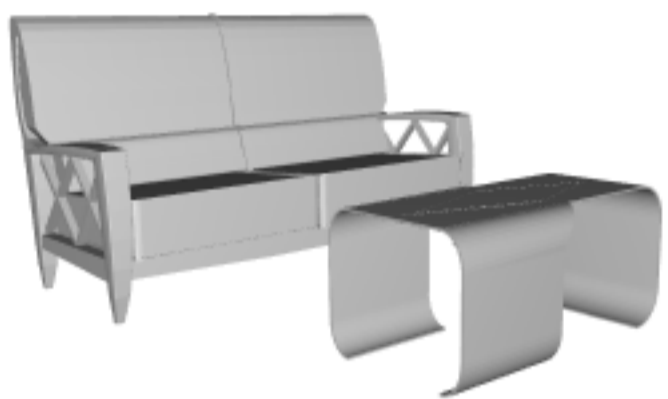

0.2

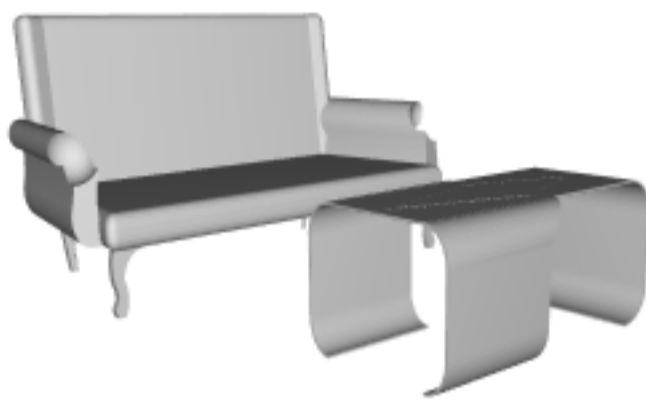

0.133333

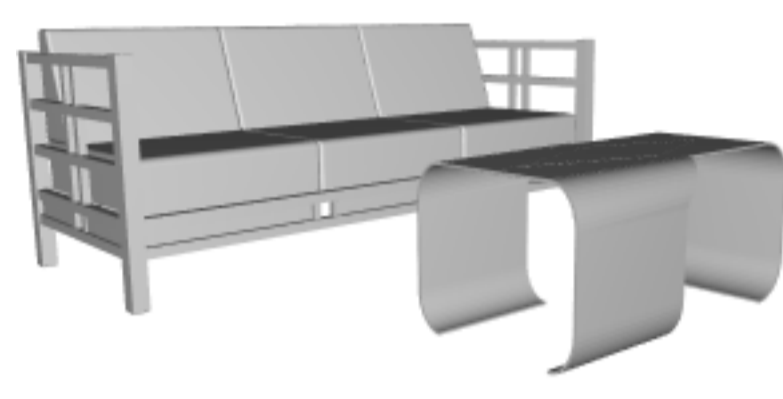

0.0666667

Task 37 of 50 Score = 0.52939



0.533333



0.466667



0.4



0.266667



0.2



0.133333

Task 38 of 50 Score = 0.52939

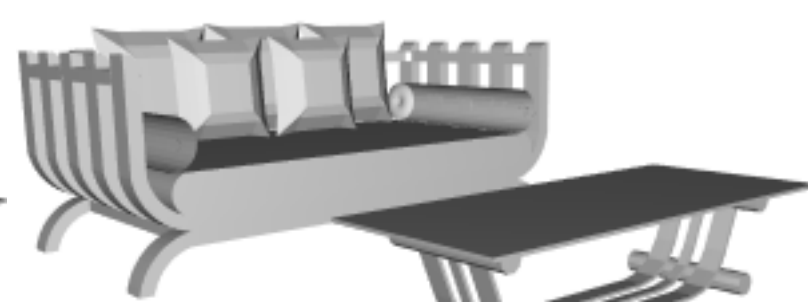
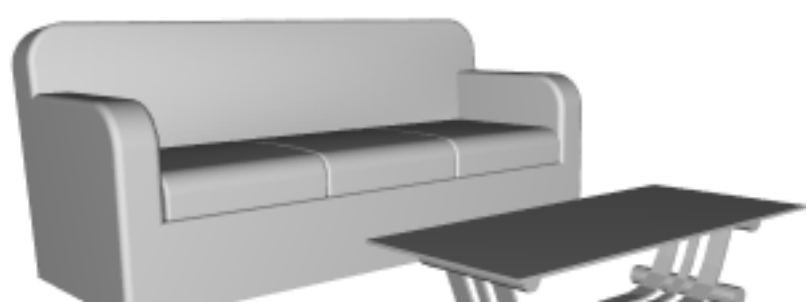

0.533333



0.466667

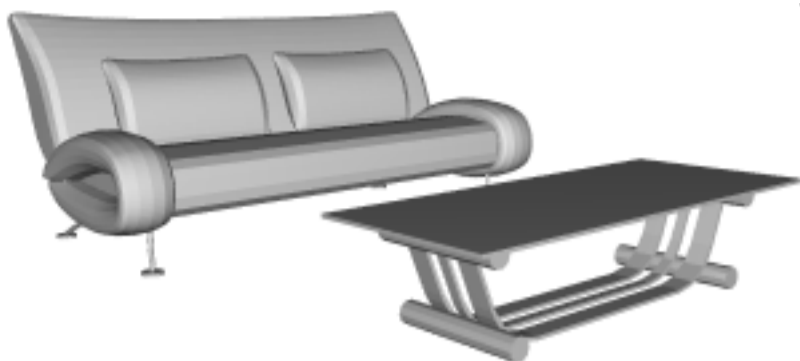

0.4



0.333333

0.2

0.066667

Task 39 of 50 Score = 0.52939



0.533333

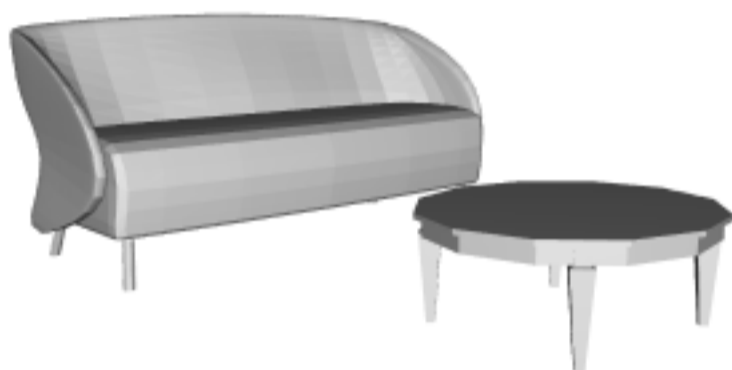

0.466667



0.466667



0.2



0.2

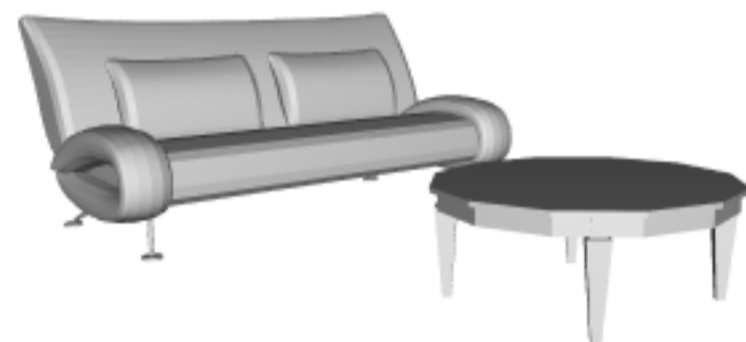

0.133333

Task 40 of 50 Score = 0.52939

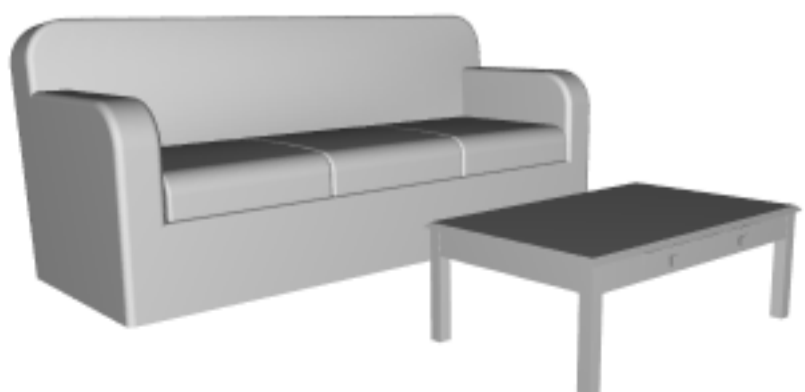

0.533333

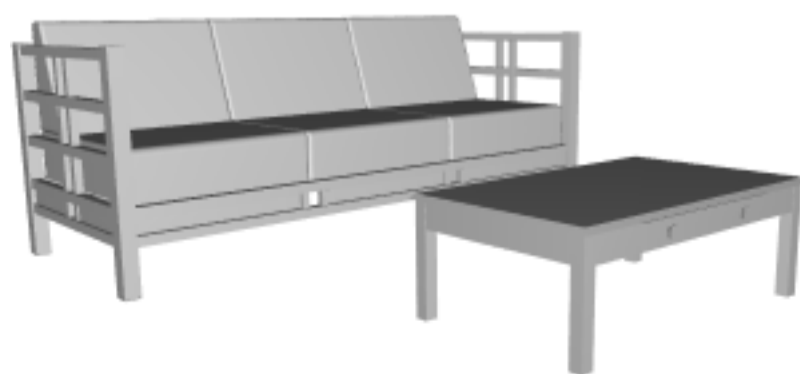

0.533333

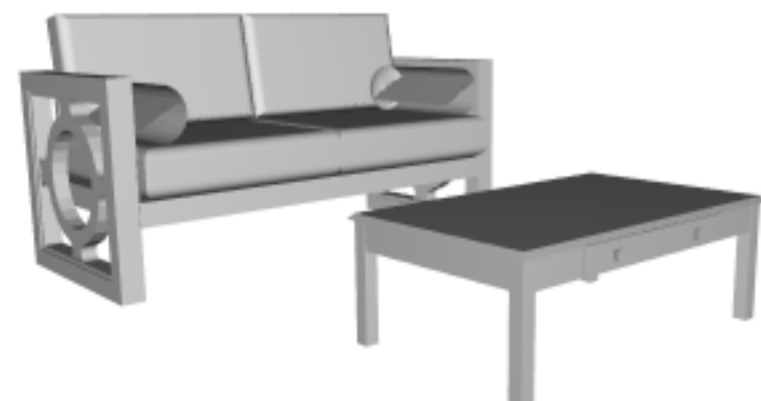

0.4





0.2

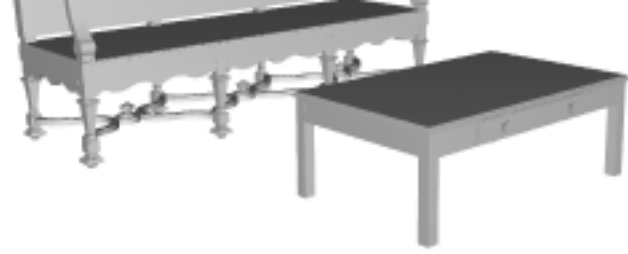

0.2



0.133333

Task 41 of 50 Score = 0.52939

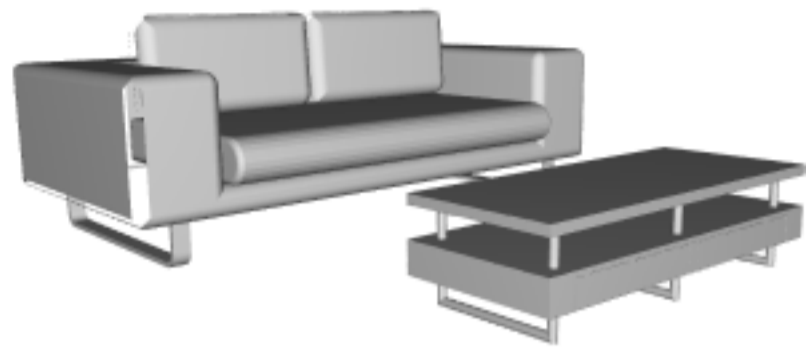

0.533333



0.533333



0.4

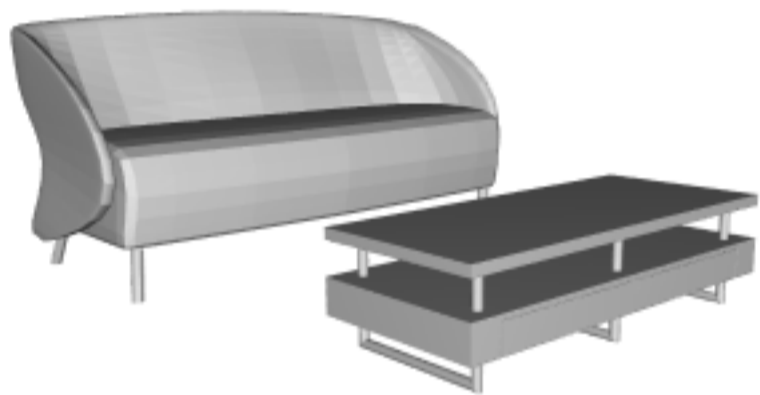

0.266667

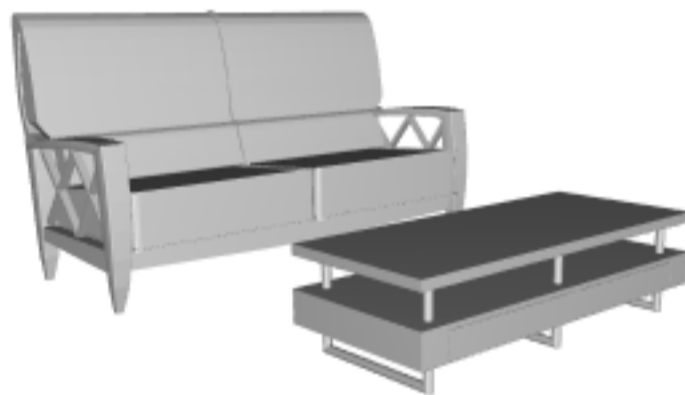

0.133333

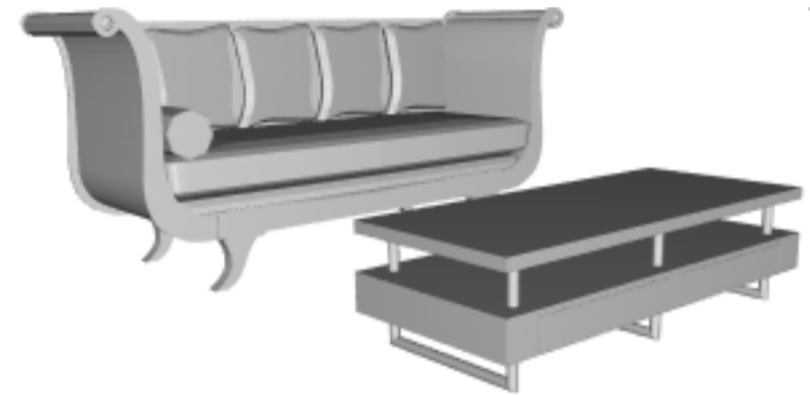

0.133333

Task 42 of 50 Score = 1.03114



0.470588



0.411765



0.352941



0.294118



0.294118



0.176471

Task 43 of 50 Score = 1.21823

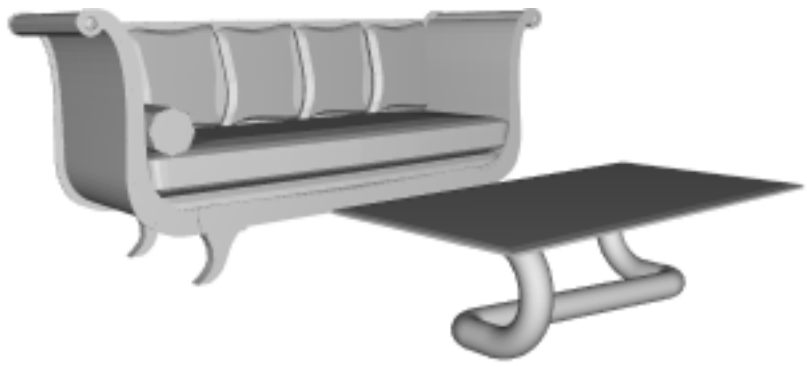

0.466667



0.466667

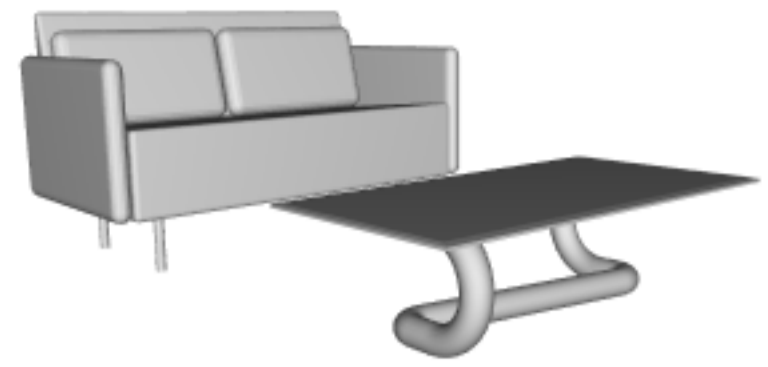

0.466667

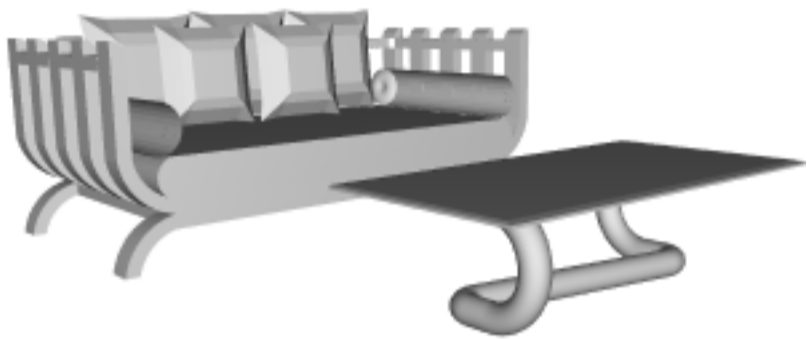

0.266667

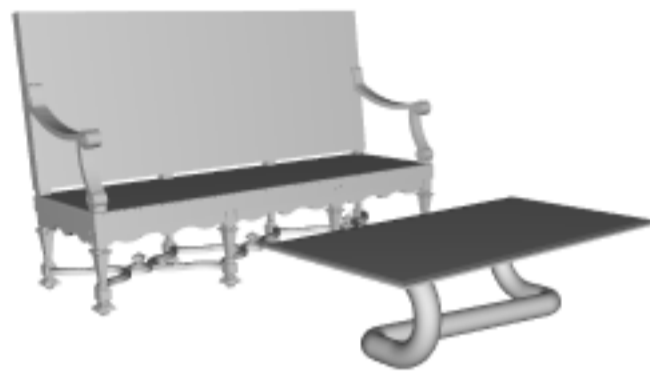

0.2

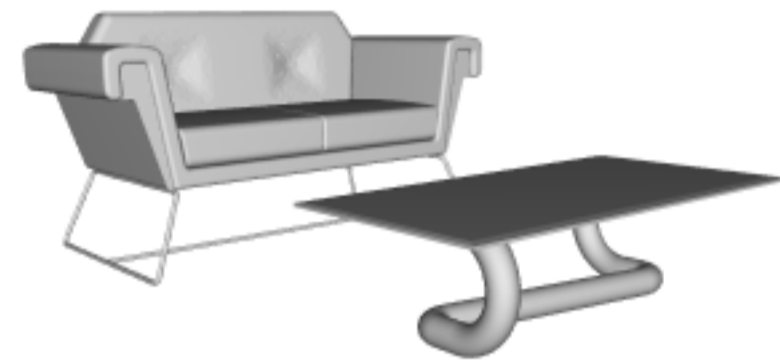

0.133333

Task 44 of 50 Score = 1.21823



0.466667



0.466667

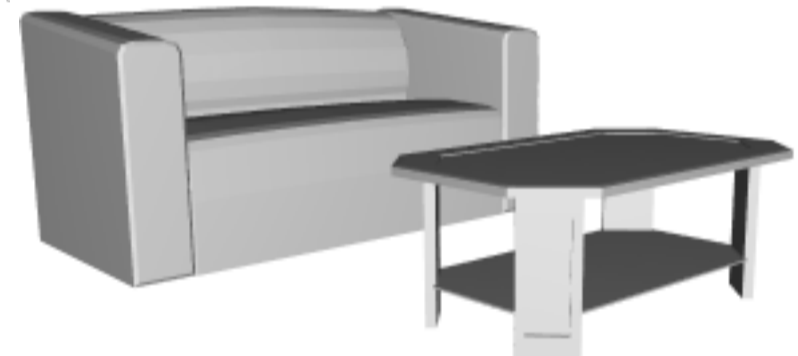

0.4



0.333333



0.266667



0.0666667

Task 45 of 50 Score = 1.21823

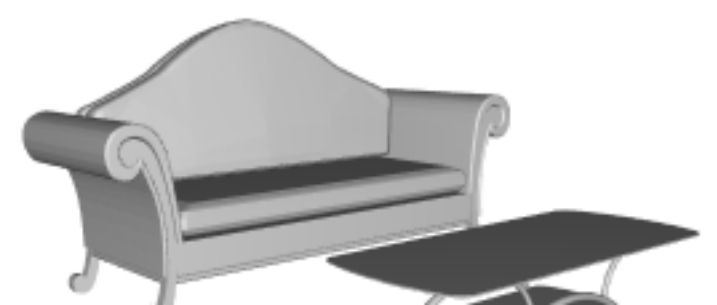

0.466667



0.466667



0.4

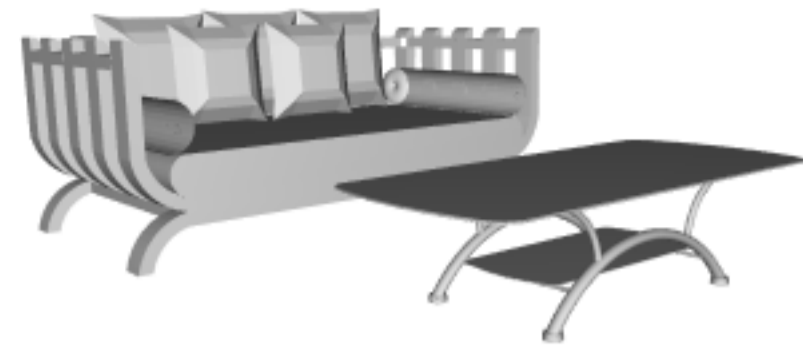

0.266667

0.2

0.2

Task 46 of 50 Score = 1.21823



0.466667

0.466667

0.4



0.333333

0.2

0.133333

Task 47 of 50 Score = 1.21823



0.466667

0.466667

0.4



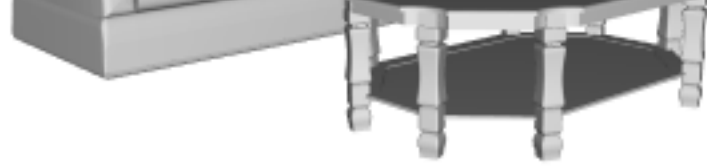

0.333333



0.2



0.133333

Task 48 of 50 Score = 1.21823



0.466667



0.4



0.4



0.266667

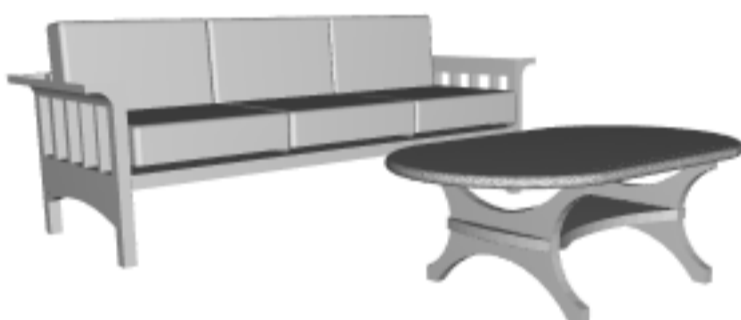

0.266667



0.2

Task 49 of 50 Score = 1.9564



0.411765



0.411765



0.352941



0.294118



0.294118



0.235294

Task 50 of 50 Score = 1.9564

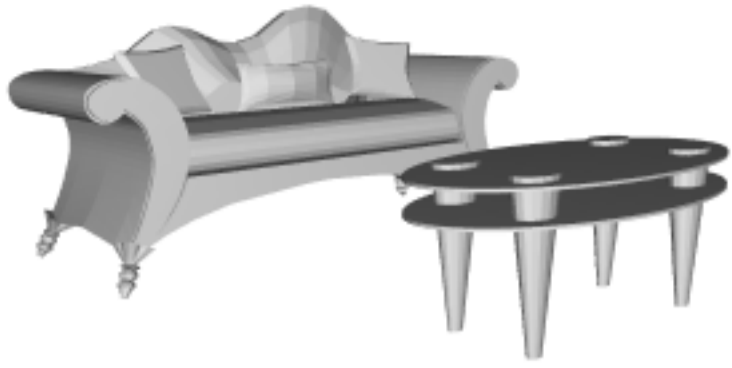

0.411765

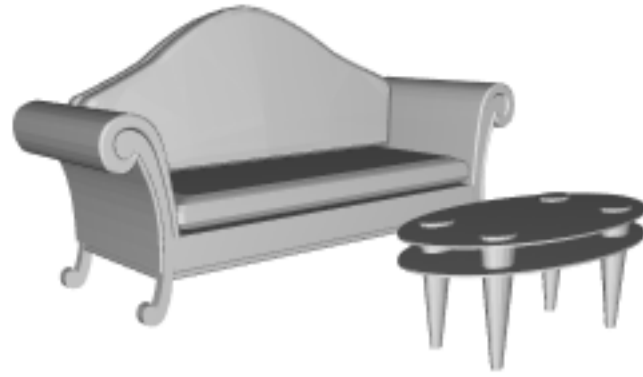

0.352941

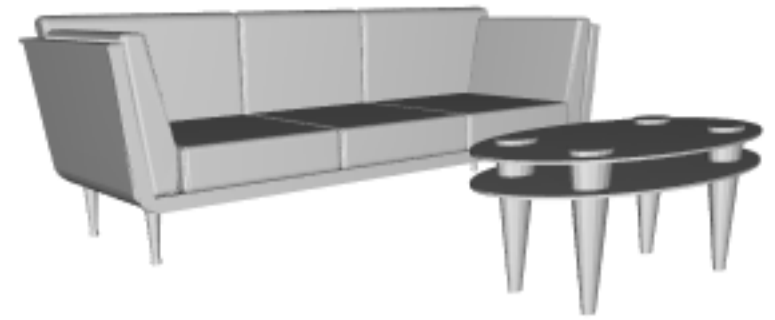

0.352941

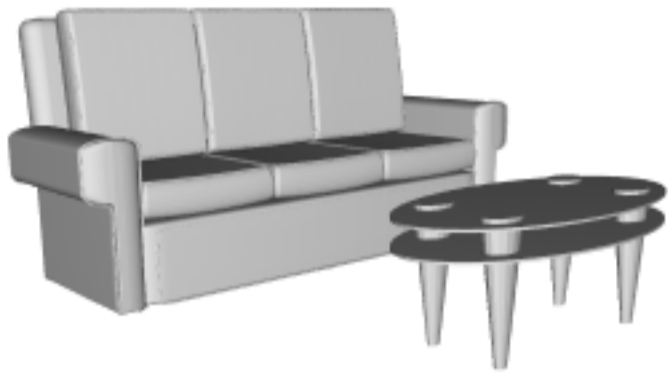

0.294118

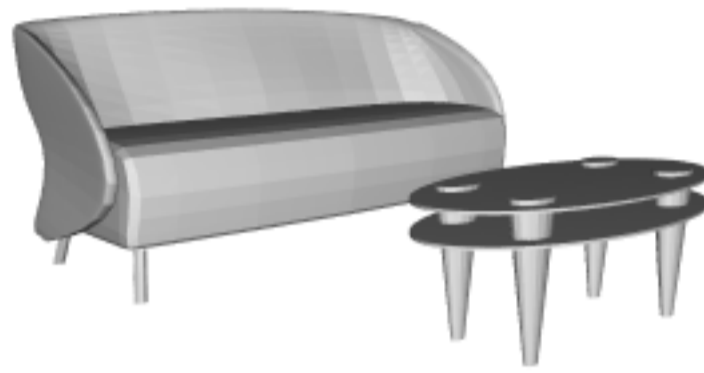

0.294118

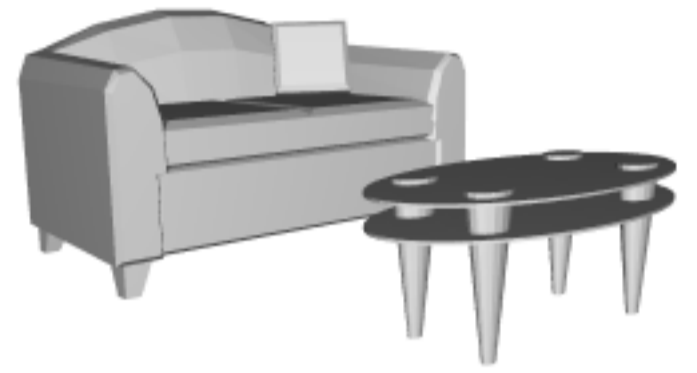

0.294118
