

Task 1 of 50 Score = 0.00326283



0.833333



0.666667



0.25

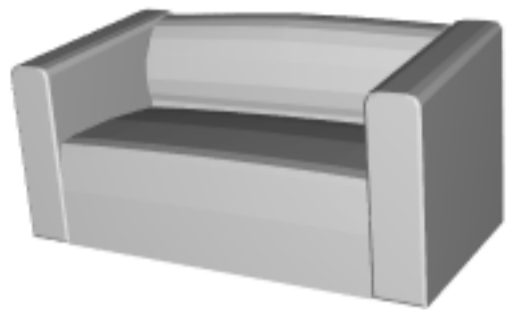

0.166667



0.0833333



0

Task 2 of 50 Score = 0.00988633

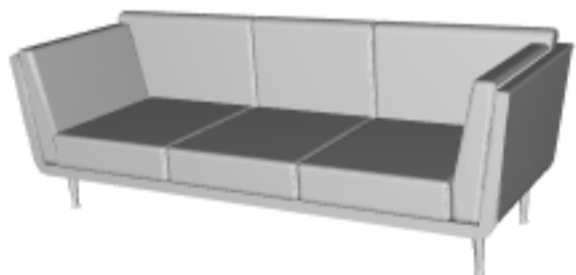

0.769231

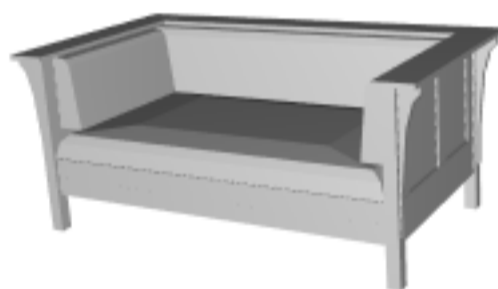

0.615385



0.307692

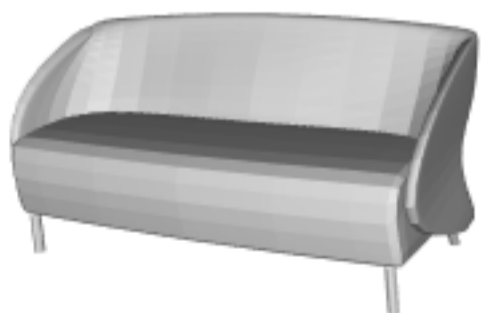

0.153846



0.153846

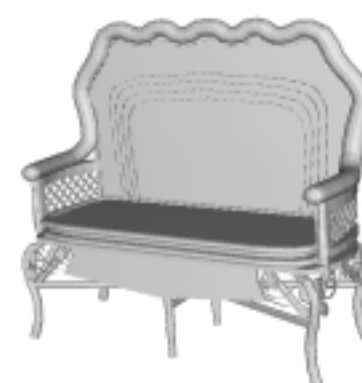

0

Task 3 of 50 Score = 0.00988633



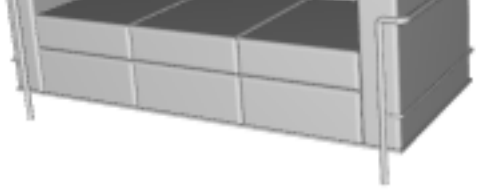

0.769231

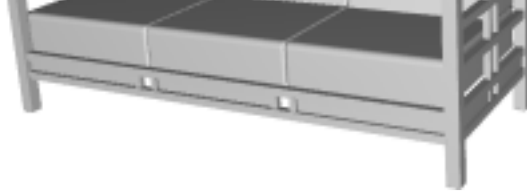

0.461538



0.384615



0.230769

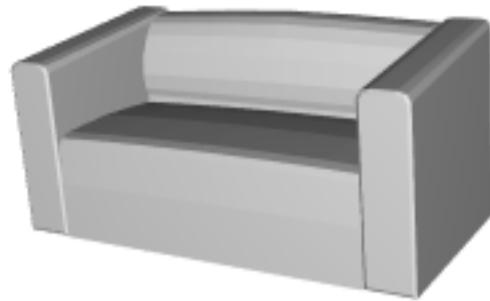

0.153846



0



Task 4 of 50 Score = 0.00988633



0.769231

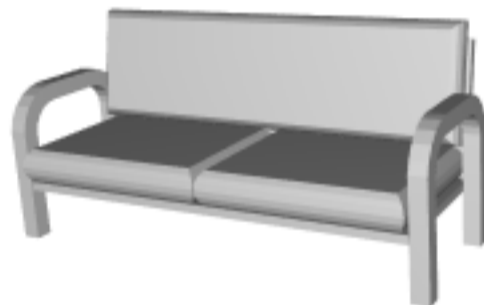

0.384615



0.307692



0.230769

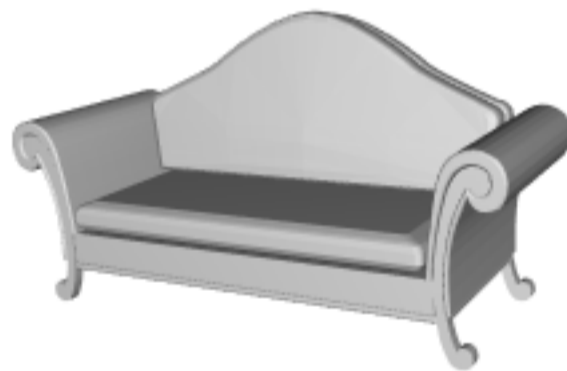

0.153846



0.153846



Task 5 of 50 Score = 0.0231333



0.75



0.666667



0.416667



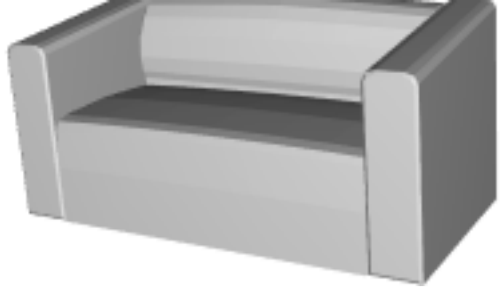

0.0833333

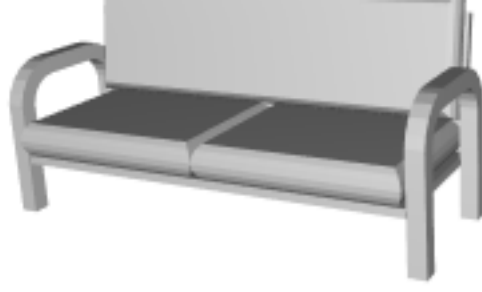

0.0833333

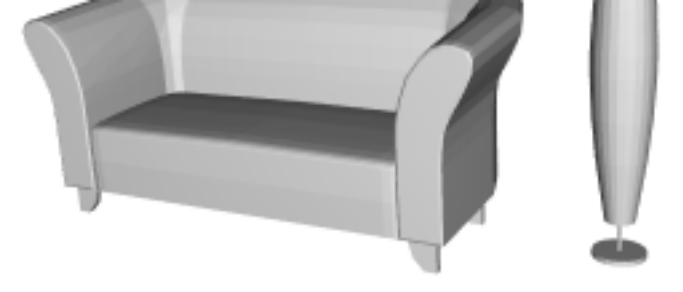

0

Task 6 of 50 Score = 0.0231333



0.75



0.333333



0.333333



0.25



0.25

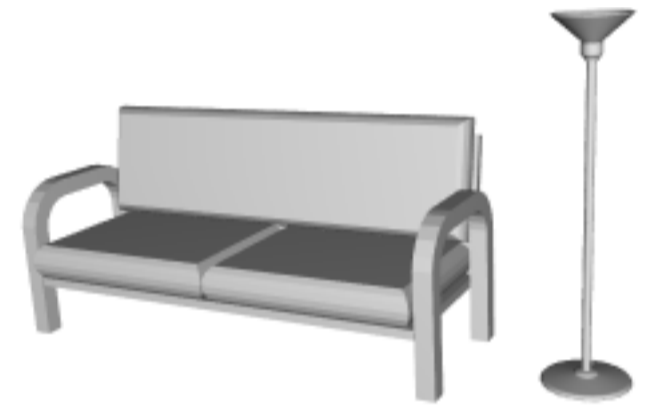

0.0833333

Task 7 of 50 Score = 0.0231333

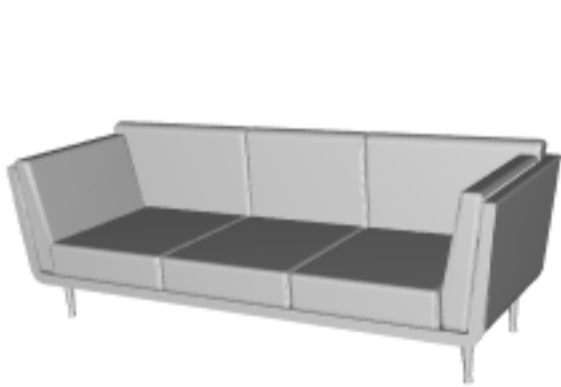

0.75

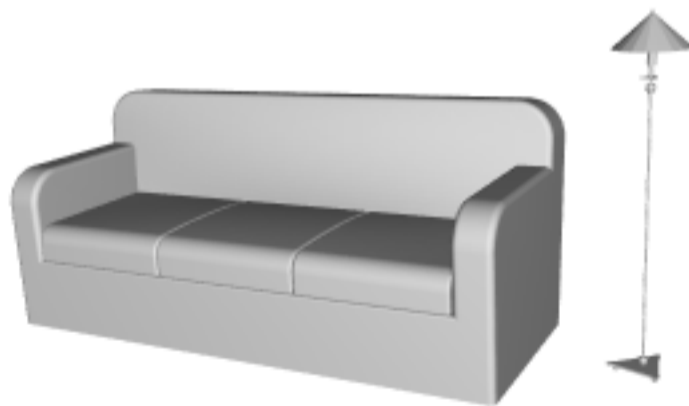

0.5



0.25

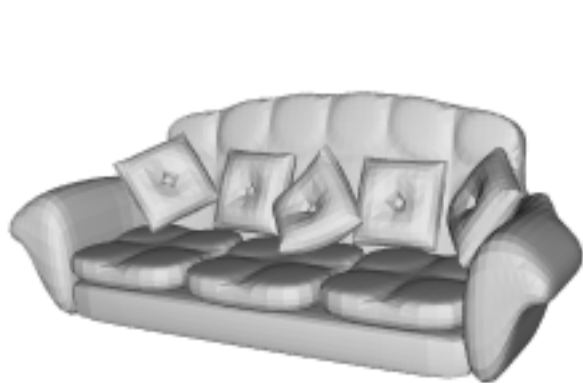

0.166667

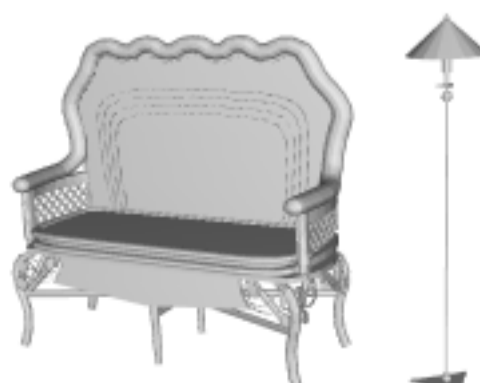

0.166667

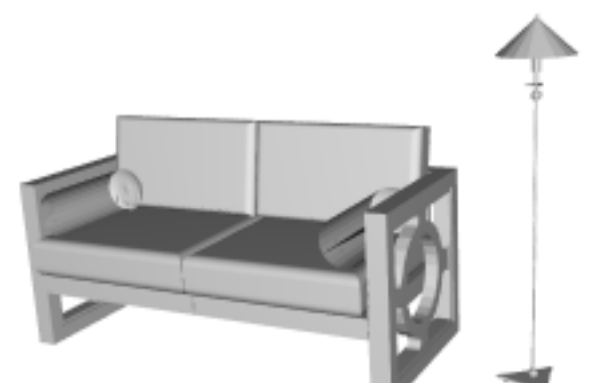

0.166667

Task 8 of 50 Score = 0.0529391



0.692308



0.461538



0.307692



0.230769

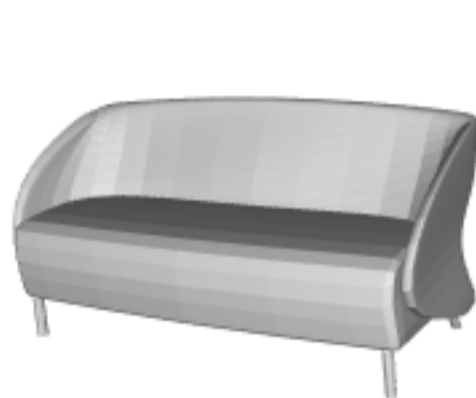

0.153846

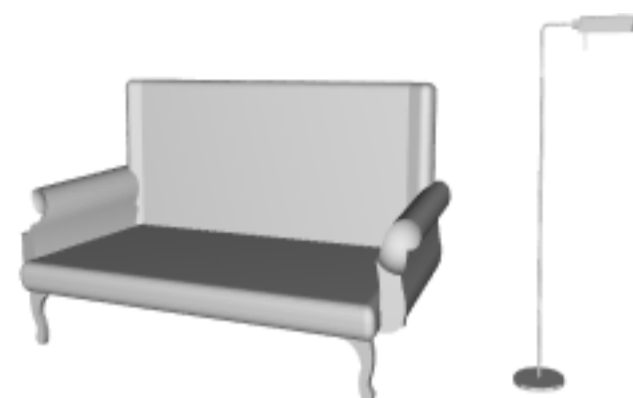

0.153846

Task 9 of 50 Score = 0.0529391



0.692308



0.538462



0.307692



0.230769



0.153846



0.0769231

Task 10 of 50 Score = 0.0529391

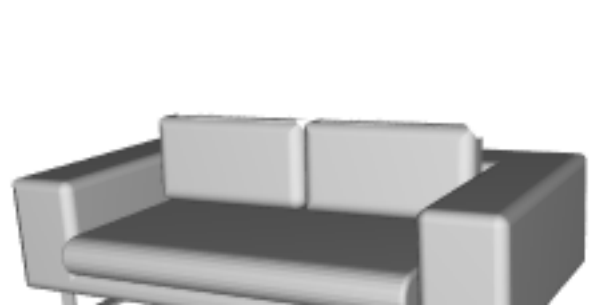

0.692308

0.461538

0.384615

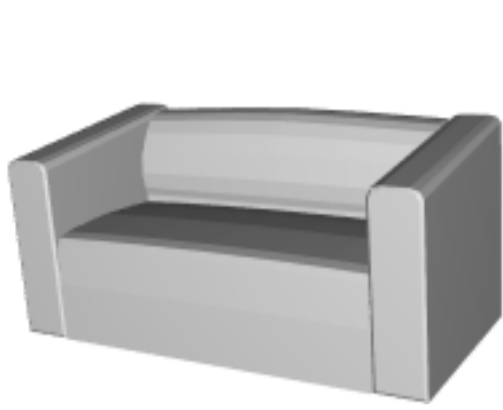

0.230769

0.153846

0.0769231



Task 11 of 50 Score = 0.0529391

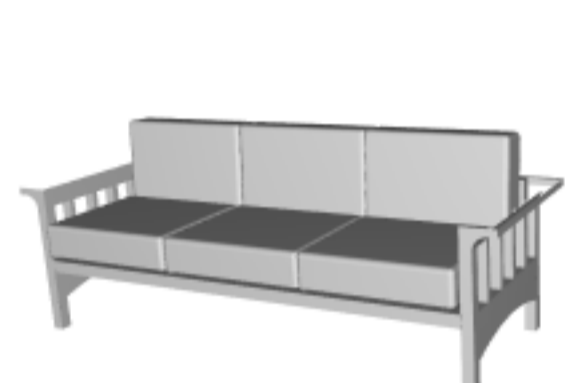

0.692308

0.461538

0.384615

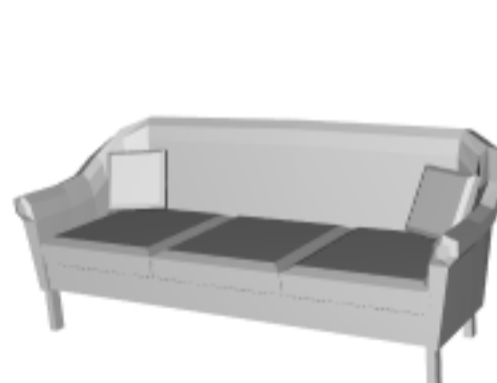

0.307692

0.153846

0



Task 12 of 50 Score = 0.112551

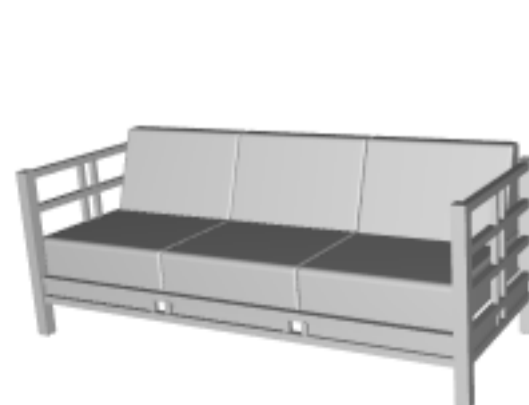
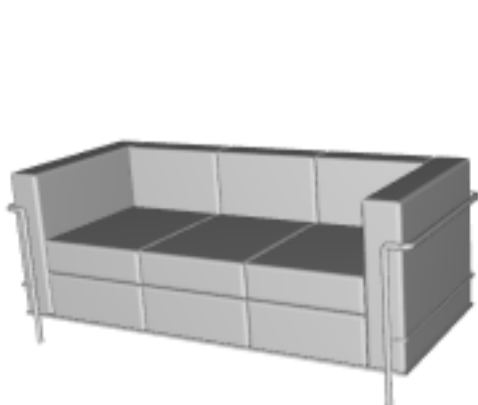

0.666667

0.583333

0.333333



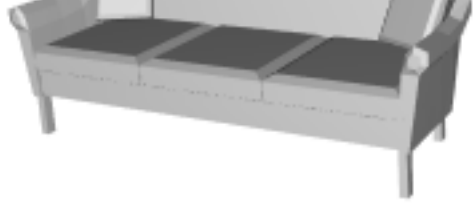

0.25



0.166667

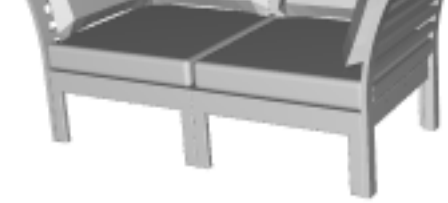

0

Task 13 of 50 Score = 0.112551

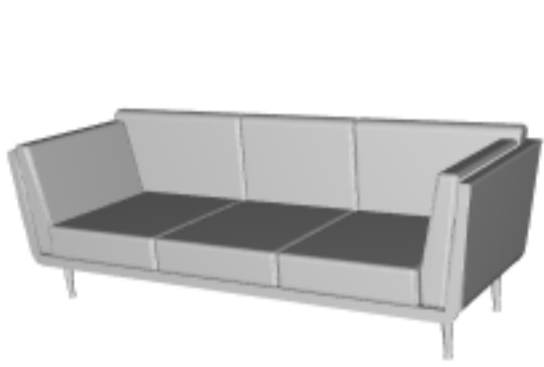

0.666667



0.5

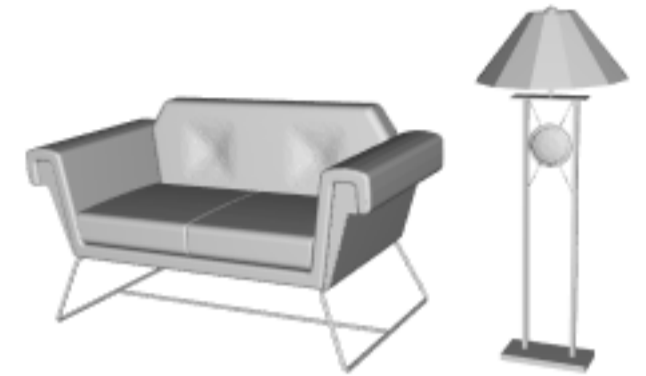

0.333333

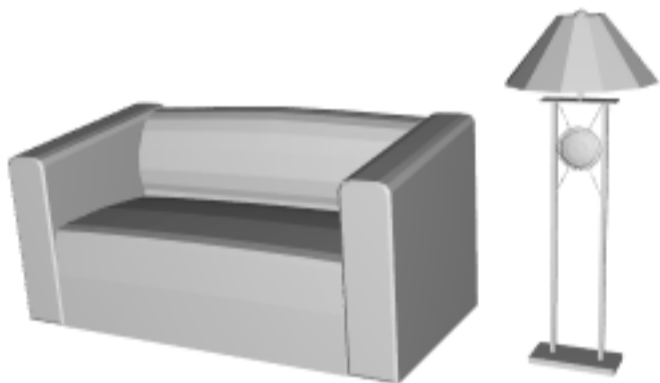

0.25

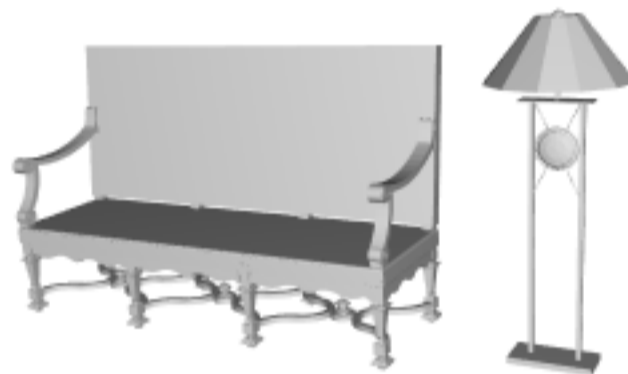

0.166667



0.0833333

Task 14 of 50 Score = 0.112551



0.666667



0.583333

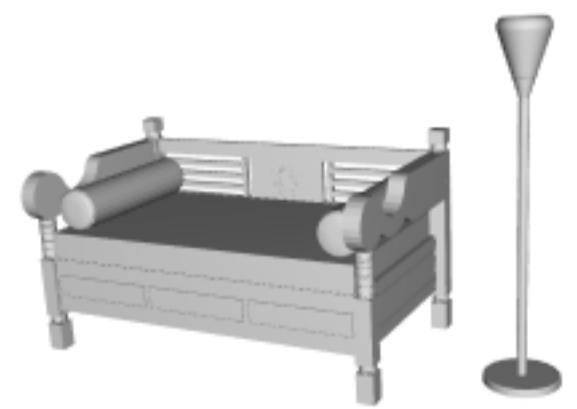

0.25



0.25



0.166667



0.0833333

Task 15 of 50 Score = 0.112551



0.666667



0.666667



0.25

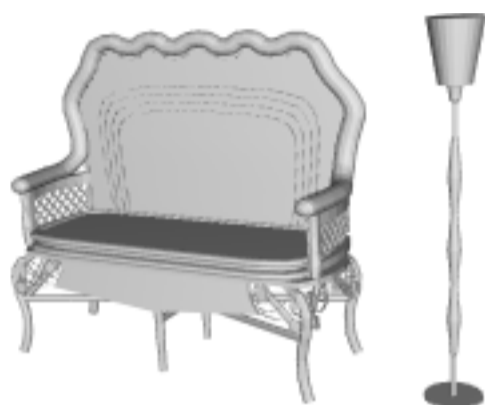

0.166667



0.166667



0.0833333

Task 16 of 50 Score = 0.112551



0.666667



0.5



0.333333



0.25

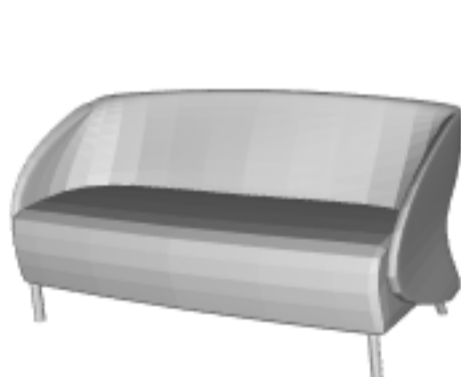

0.166667



0.0833333

Task 17 of 50 Score = 0.112551

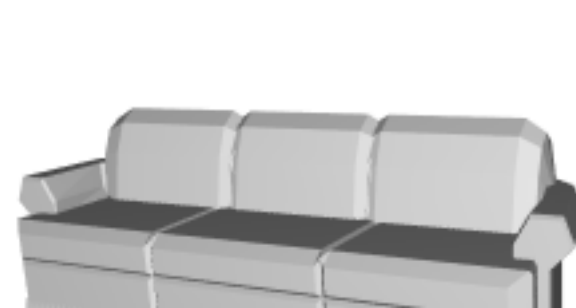



0.666667



0.583333



0.333333



0.25

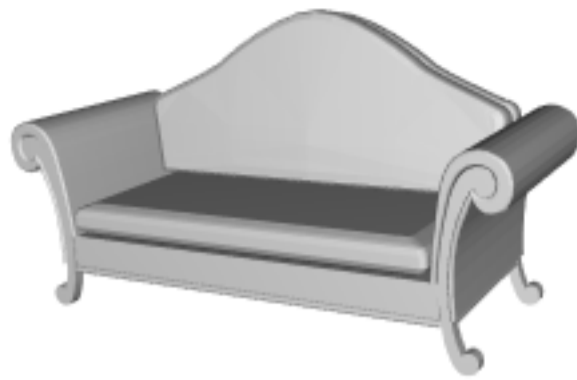

0.0833333

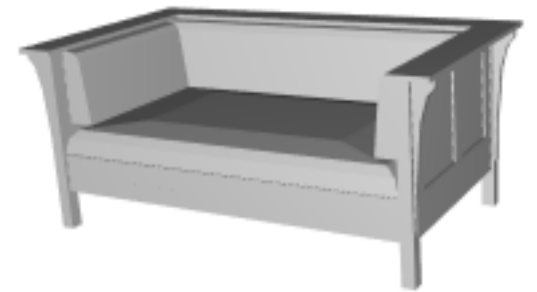

0.0833333

Task 18 of 50 Score = 0.112551



0.666667

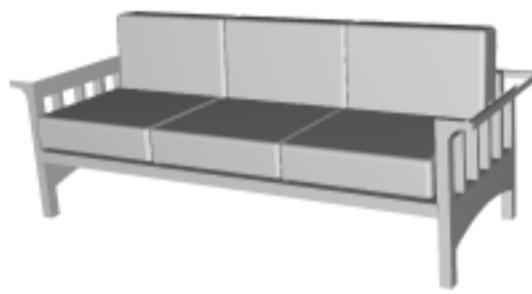

0.416667

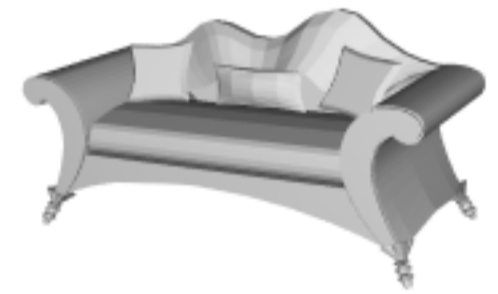

0.25



0.25

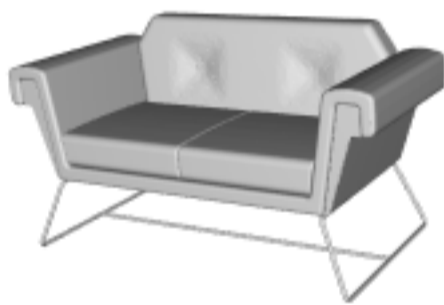

0.25



0.166667

Task 19 of 50 Score = 0.207929



0.615385

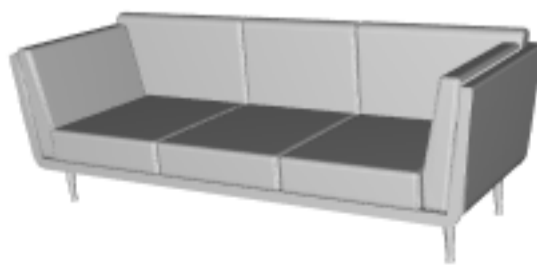

0.615385

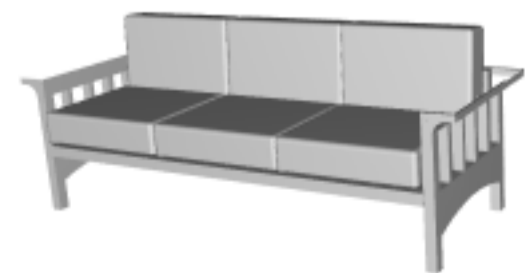

0.384615



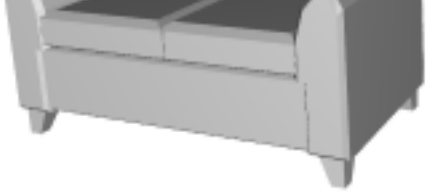

0.230769



0.0769231

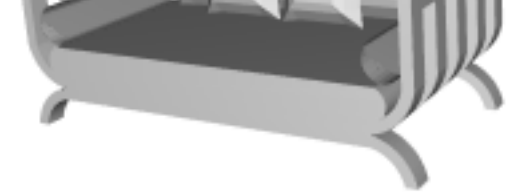

0.0769231



Task 20 of 50 Score = 0.207929

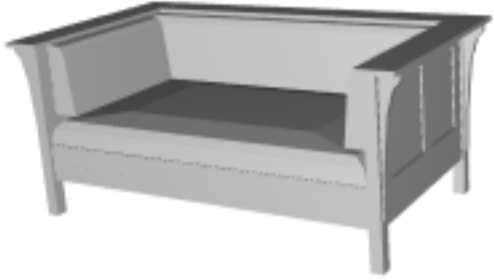

0.615385

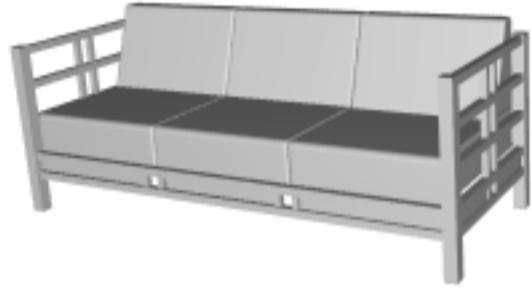

0.538462

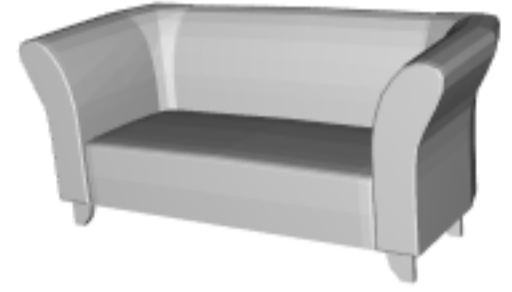

0.384615



0.230769



0.153846



0.0769231



Task 21 of 50 Score = 0.207929



0.615385

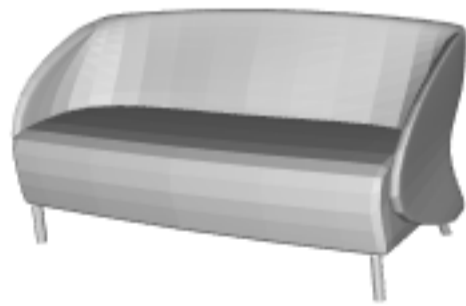

0.461538



0.307692

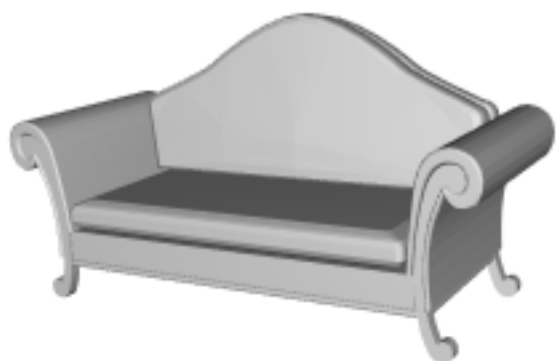

0.230769

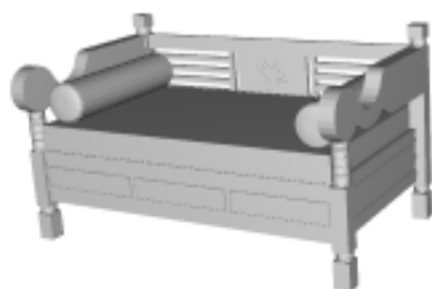

0.230769



0.153846



Task 22 of 50 Score = 0.207929



0.615385



0.538462

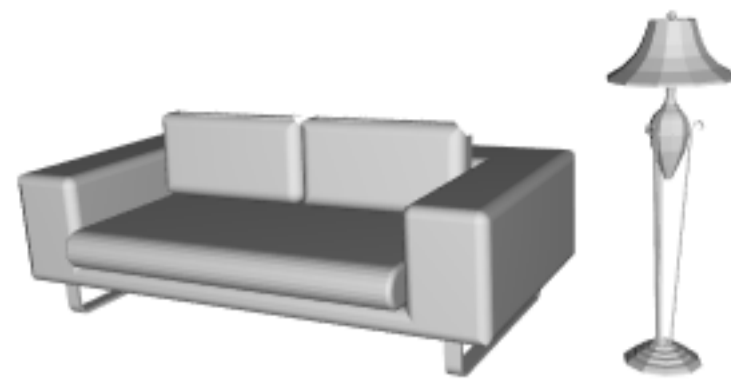

0.384615



0.230769



0.153846

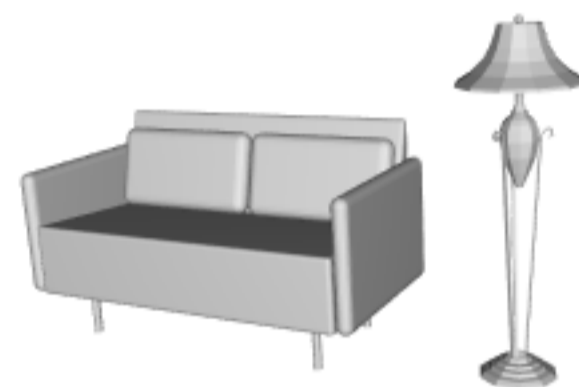

0.0769231

Task 23 of 50 Score = 0.207929



0.615385



0.461538



0.307692



0.307692



0.153846



0.153846

Task 24 of 50 Score = 0.207929

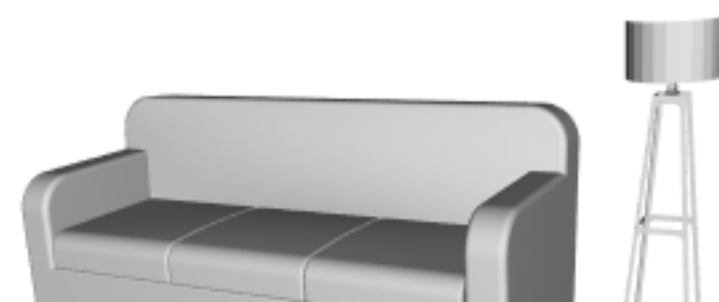
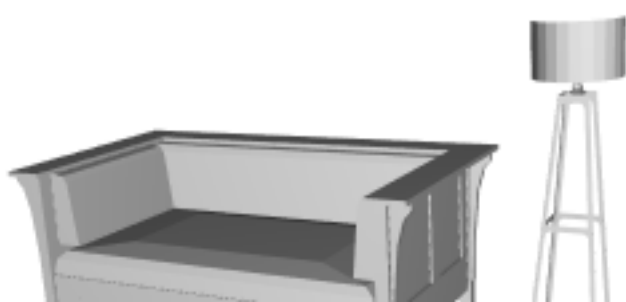

0.615385

0.461538

0.384615

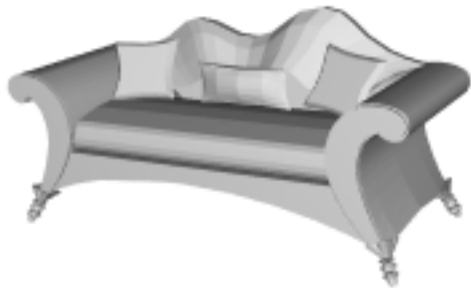

0.230769

0.230769

0.0769231

Task 25 of 50 Score = 0.207929

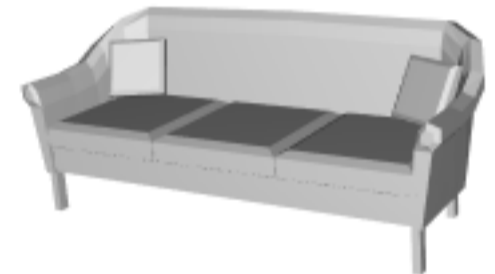

0.615385

0.461538

0.461538

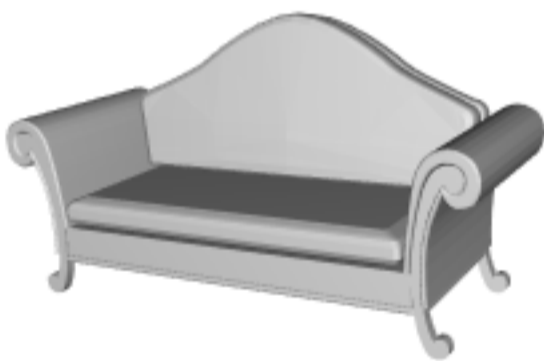

0.230769

0.153846

0.0769231

Task 26 of 50 Score = 0.207929

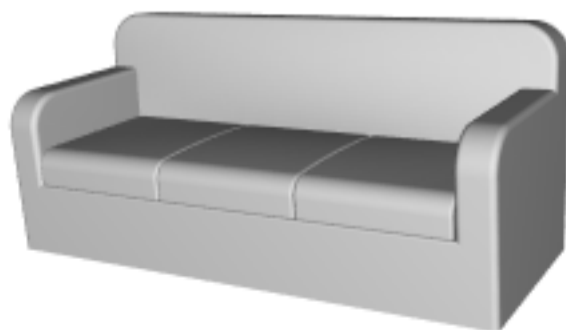
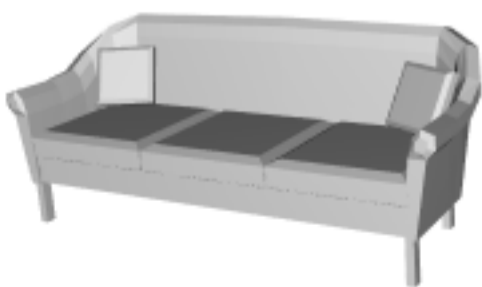

0.615385

0.538462

0.461538





0.230769

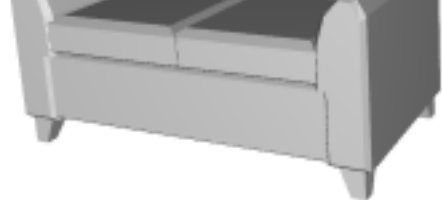

0.0769231



0.0769231

Task 27 of 50 Score = 0.207929

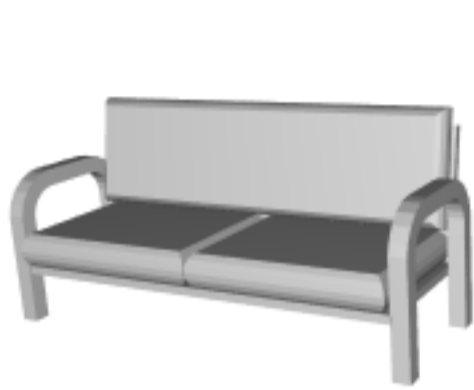

0.615385



0.384615



0.384615



0.307692



0.230769

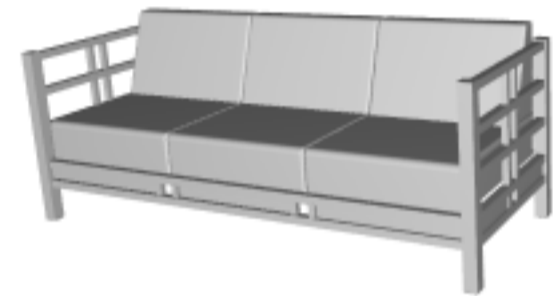

0.0769231

Task 28 of 50 Score = 0.207929



0.615385



0.461538

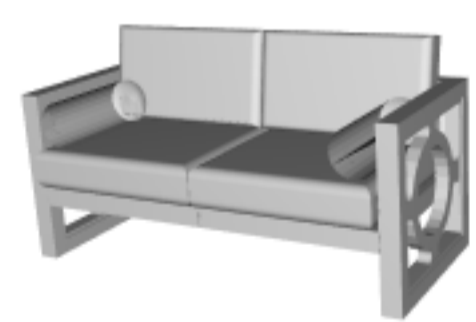

0.307692

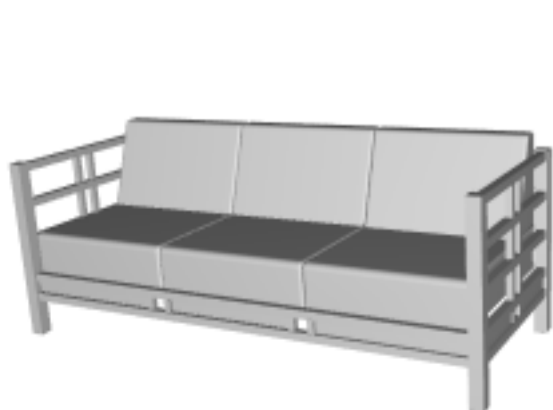

0.307692

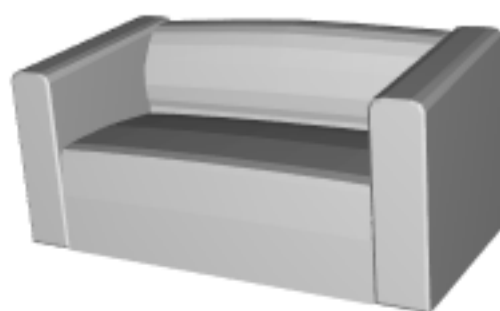

0.153846



0.153846

Task 29 of 50 Score = 0.398686



0.583333

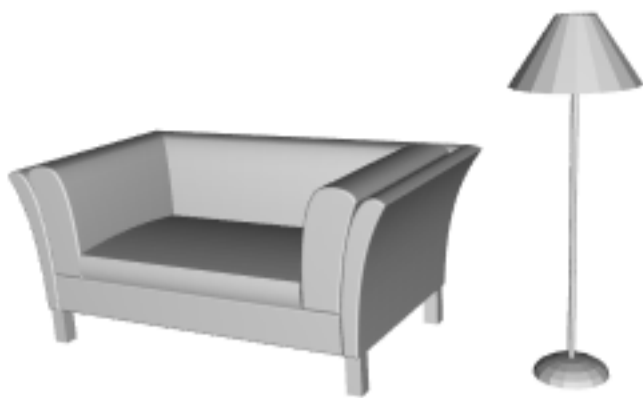

0.416667

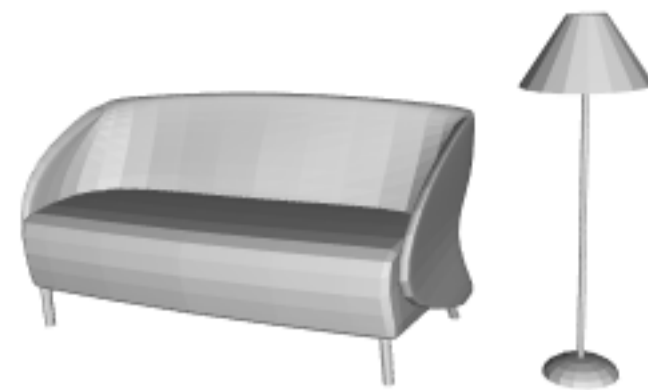

0.333333

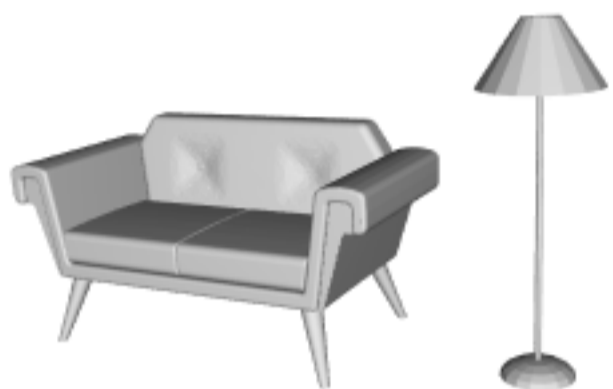

0.333333



0.25

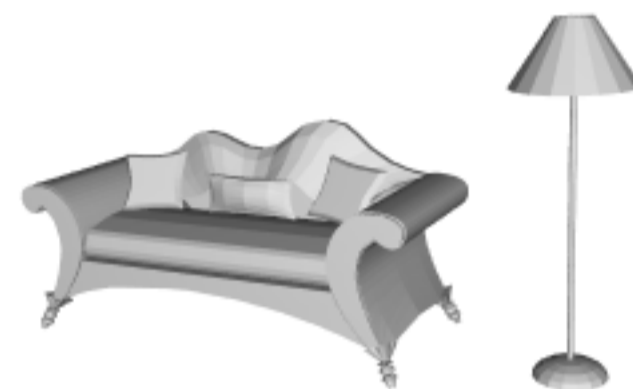

0.0833333

Task 30 of 50 Score = 0.398686



0.583333



0.333333



0.333333



0.333333

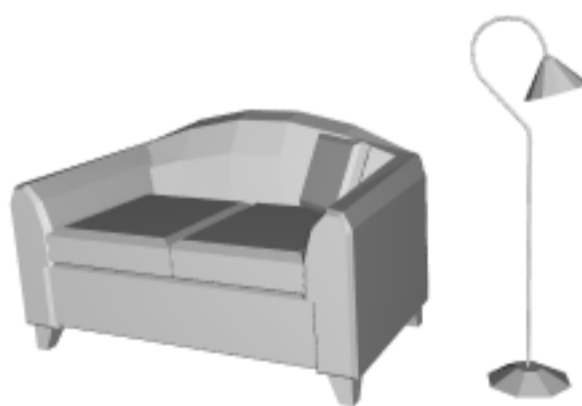

0.25



0.166667

Task 31 of 50 Score = 0.398686

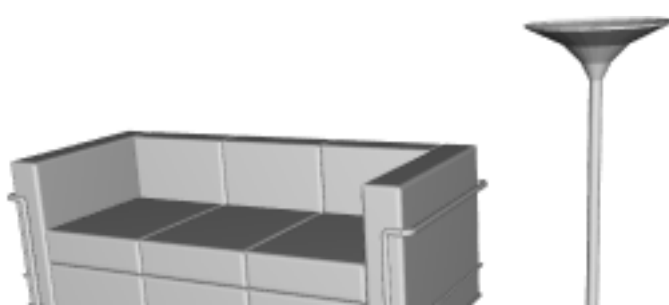
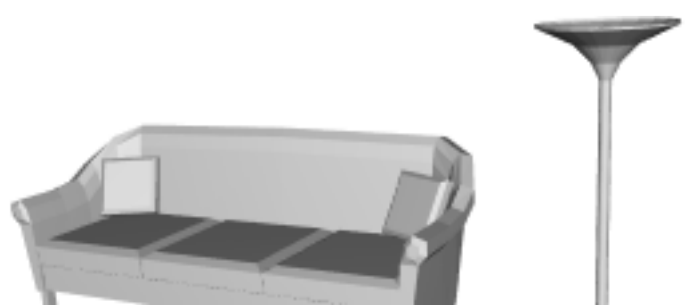

0.583333

0.5

0.333333

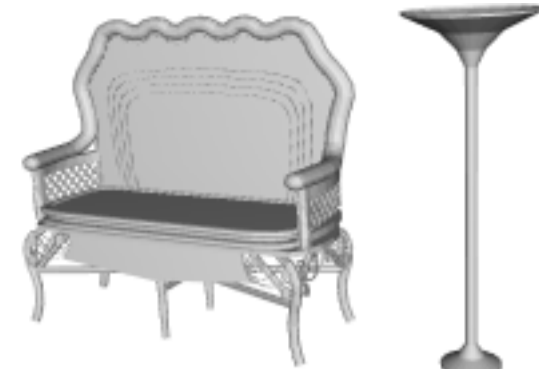

0.333333

0.166667

0.0833333

Task 32 of 50 Score = 0.398686



0.583333

0.5

0.416667

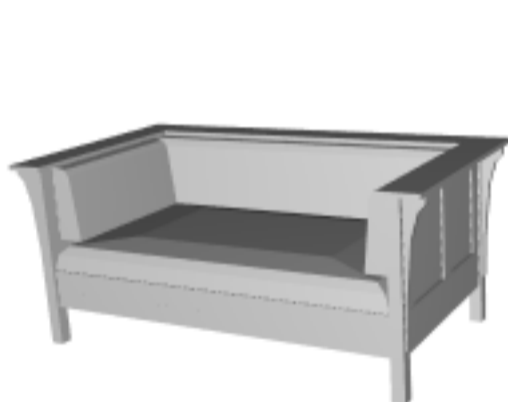

0.25

0.166667

0.0833333

Task 33 of 50 Score = 0.398686



0.583333

0.416667

0.333333





0.333333



0.25

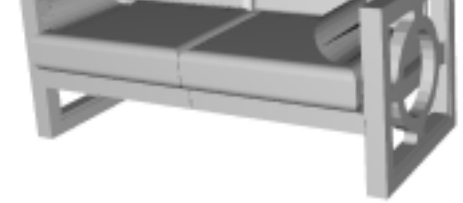

0.0833333

Task 34 of 50 Score = 0.398686



0.583333

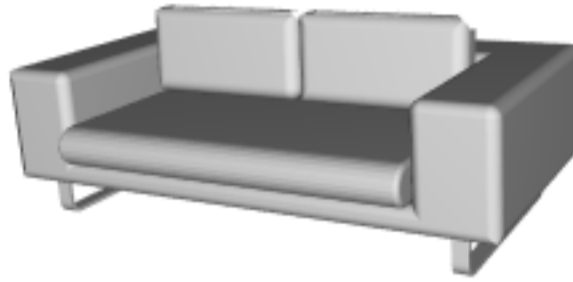

0.5



0.333333

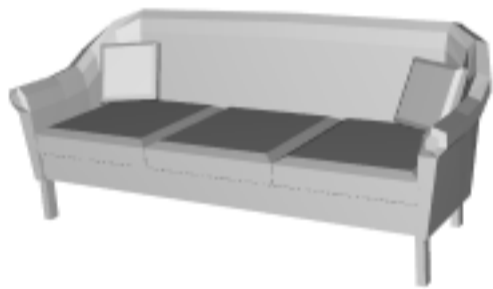

0.25

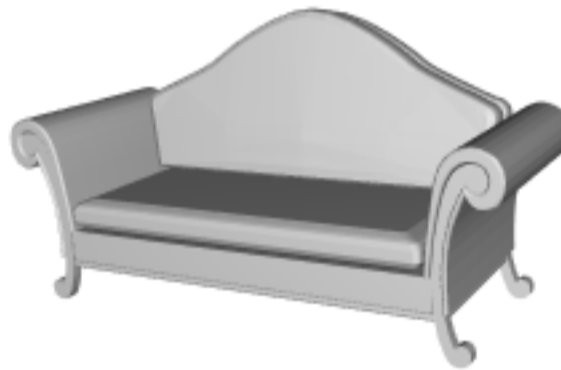

0.166667

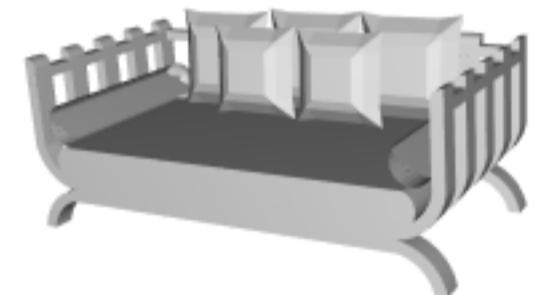

0.166667



Task 35 of 50 Score = 0.398686



0.583333

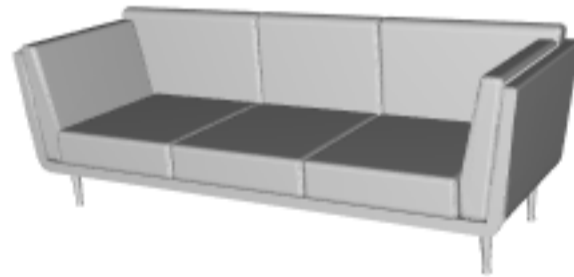

0.5

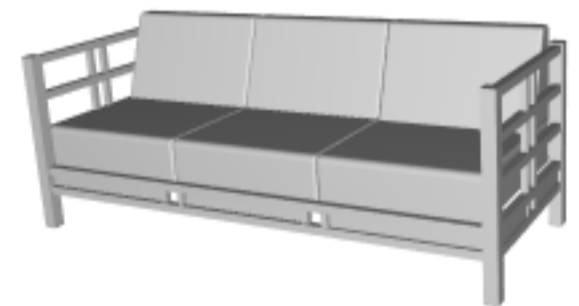

0.416667



0.25

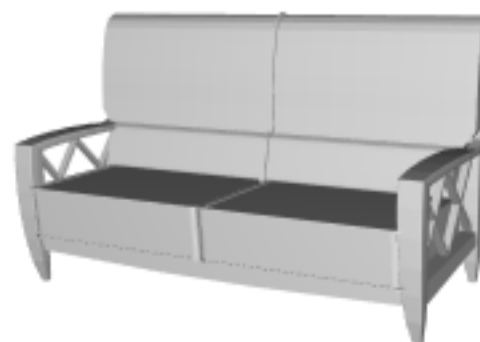

0.25

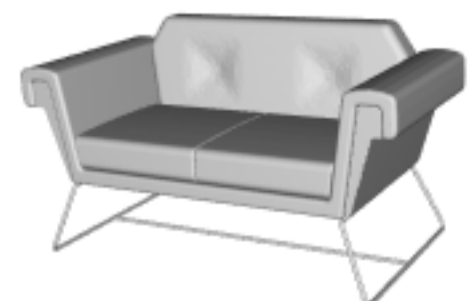

0



Task 36 of 50 Score = 0.398686



0.583333

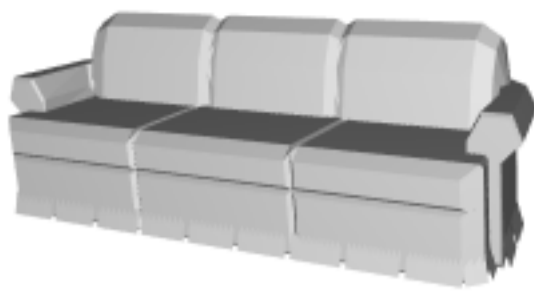

0.5

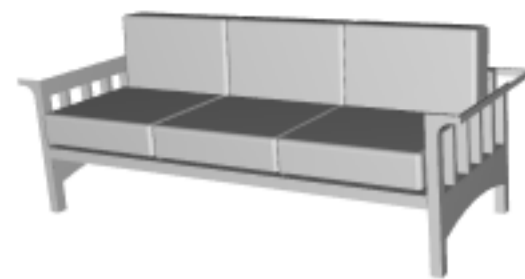

0.333333

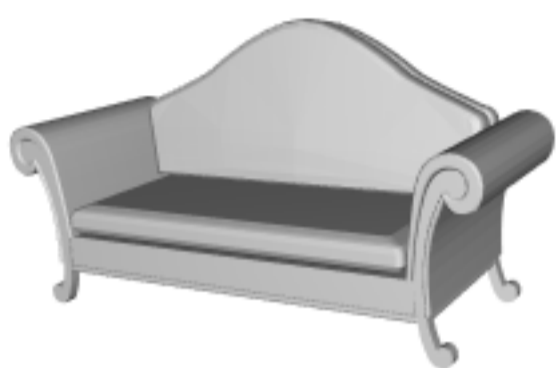

0.25



0.25

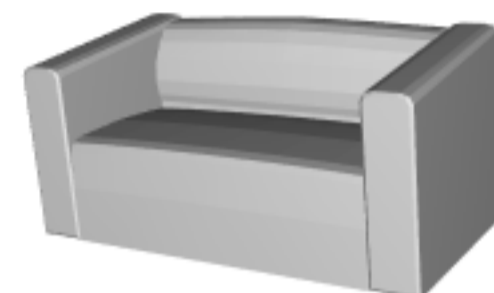

0.0833333

Task 37 of 50 Score = 0.398686

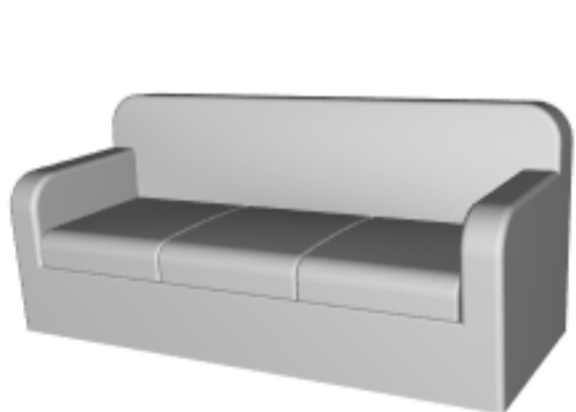

0.583333



0.5

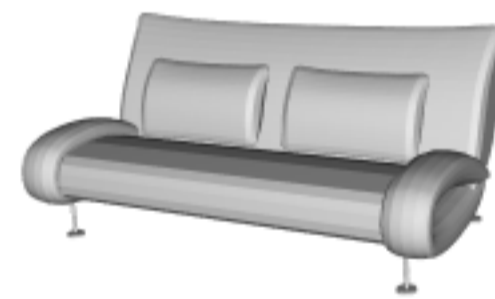

0.333333



0.25



0.166667



0.166667

Task 38 of 50 Score = 0.398686

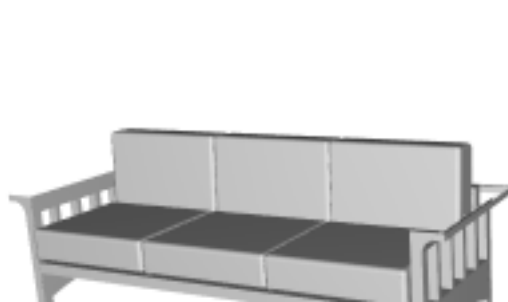
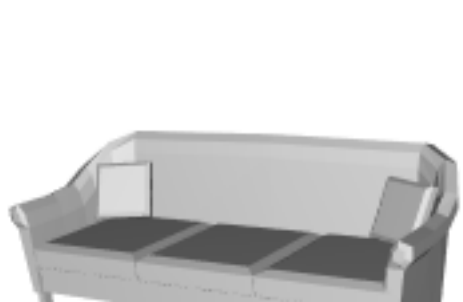

0.583333

0.583333

0.25

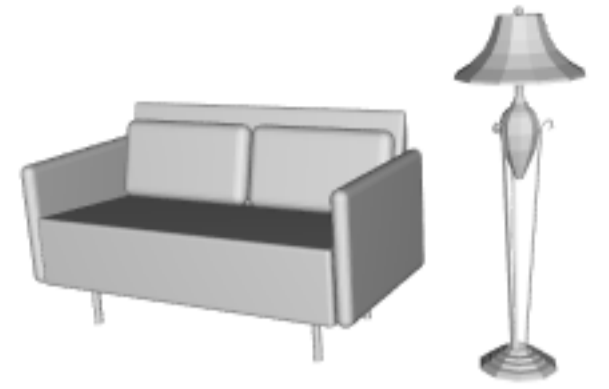
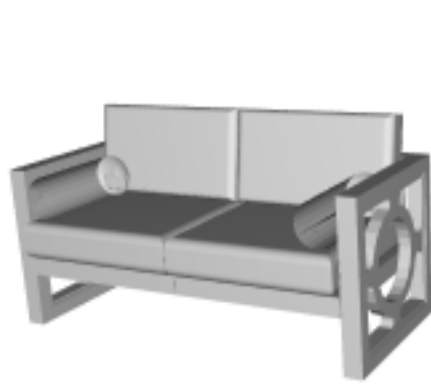

0.25

0.166667

0.166667

Task 39 of 50 Score = 0.398686



0.583333

0.416667

0.25

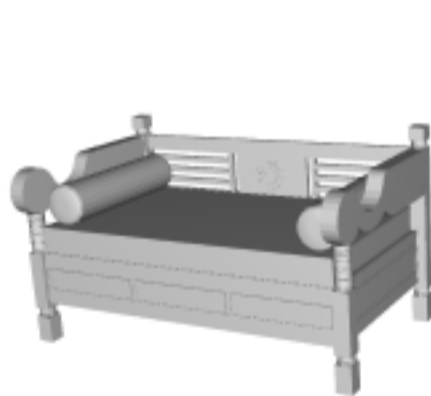

0.25

0.25

0.25

Task 40 of 50 Score = 0.621235

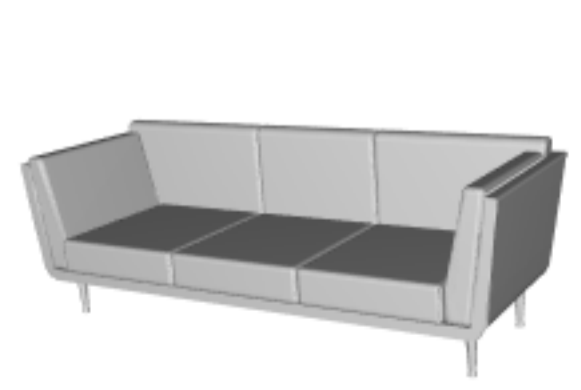

0.538462

0.538462

0.307692



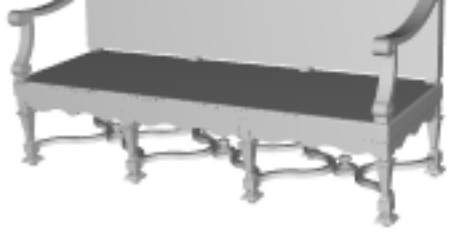

0.307692

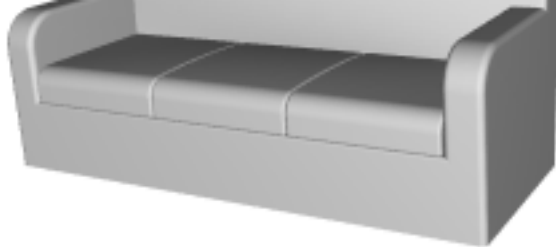

0.230769



0.0769231



Task 41 of 50 Score = 0.621235



0.538462



0.384615

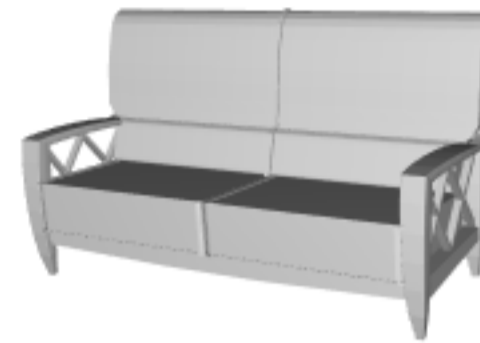

0.307692

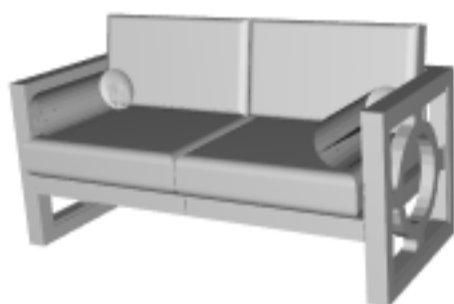

0.307692



0.230769

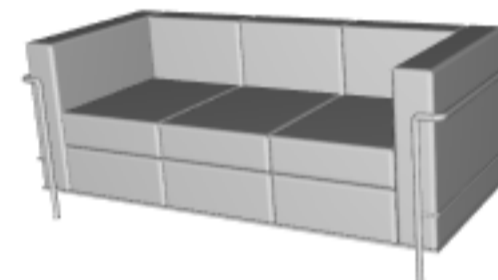

0.230769



Task 42 of 50 Score = 0.621235

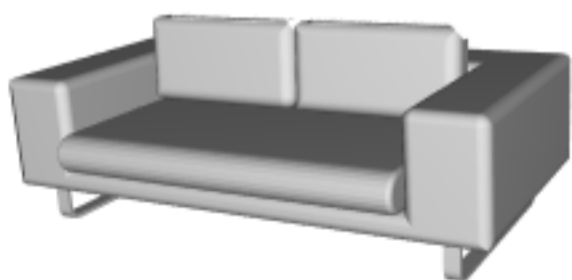

0.538462

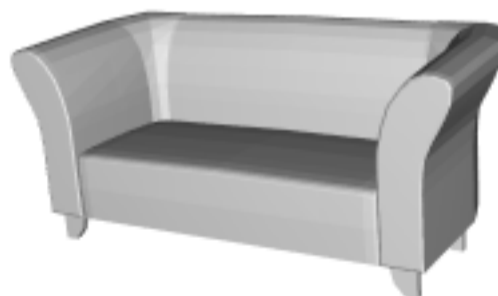

0.461538



0.384615



0.307692



0.230769

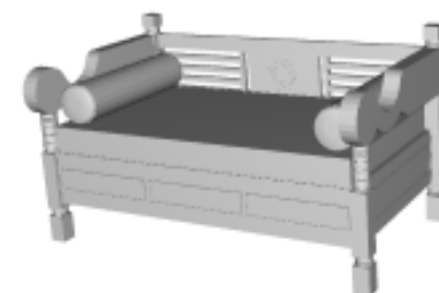

0.0769231



Task 43 of 50 Score = 0.621235



0.538462

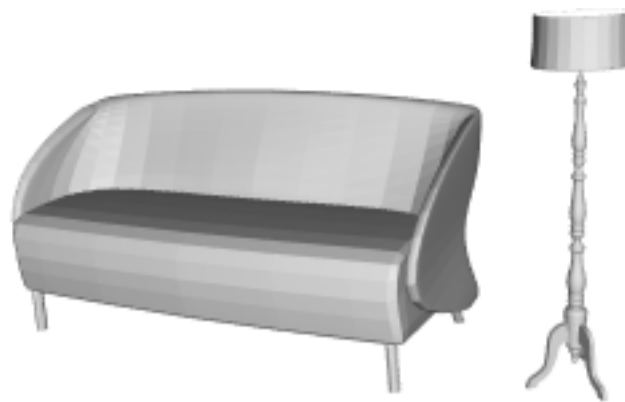

0.461538



0.384615



0.307692



0.153846



0.153846

Task 44 of 50 Score = 0.621235



0.538462



0.461538



0.461538



0.230769

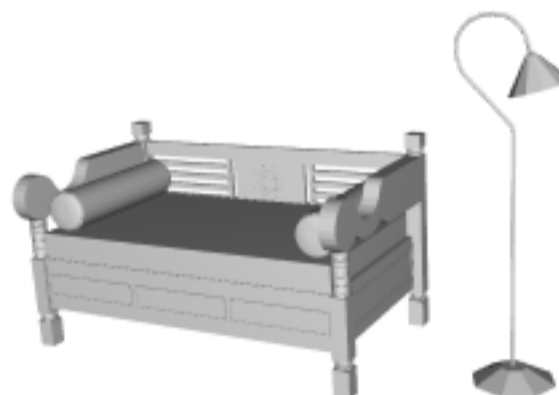

0.153846

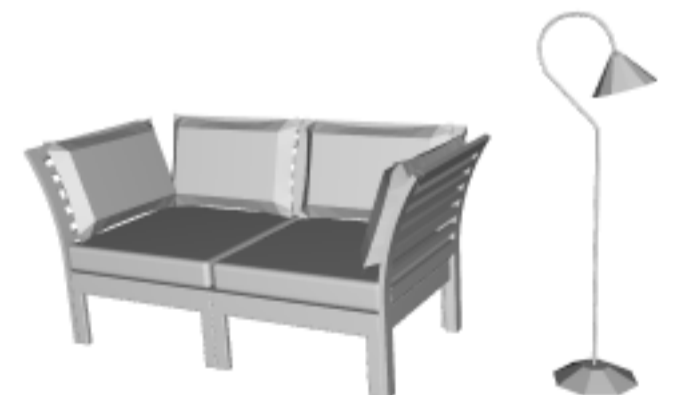

0.153846

Task 45 of 50 Score = 1.06633

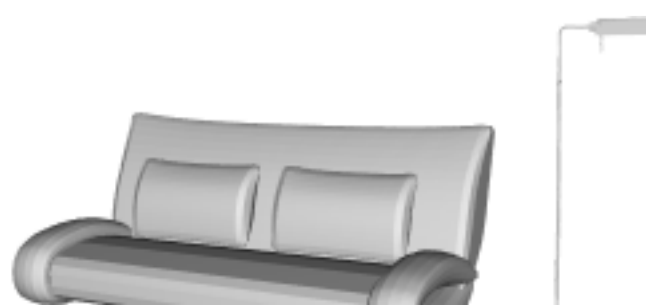
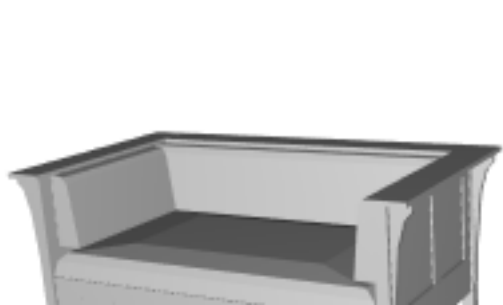

0.5

0.5

0.416667

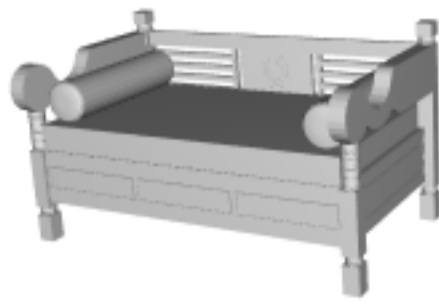
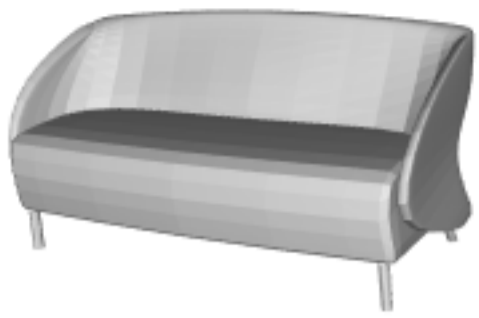

0.333333

0.166667

0.0833333



Task 46 of 50 Score = 1.06633



0.5

0.416667

0.416667

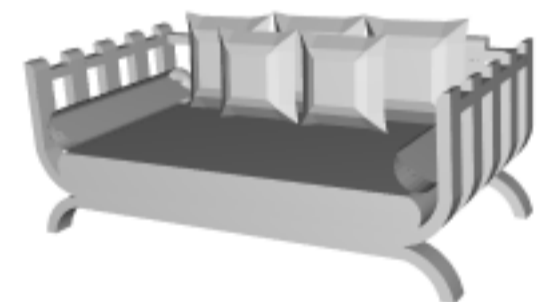
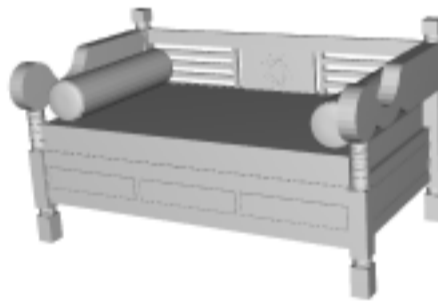
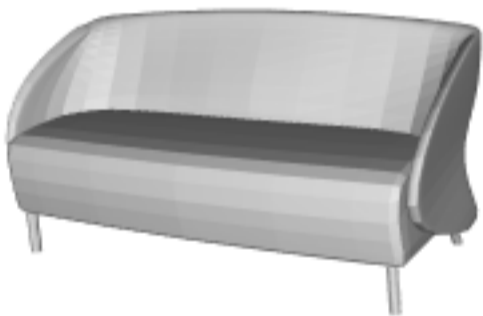

0.333333

0.166667

0.166667



Task 47 of 50 Score = 1.44785

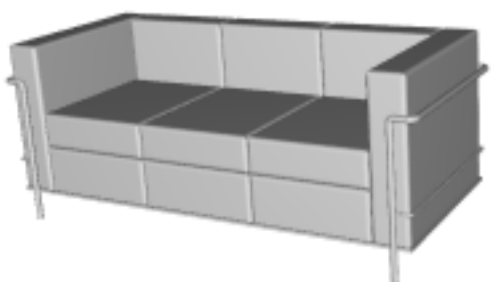

0.461538

0.461538

0.384615

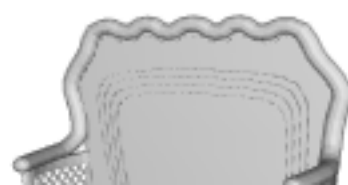



0.384615

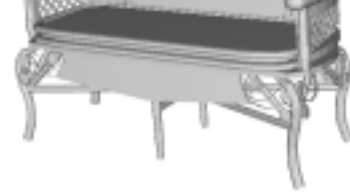

0.153846

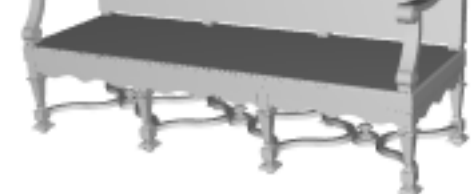

0.153846

Task 48 of 50 Score = 1.44785



0.461538

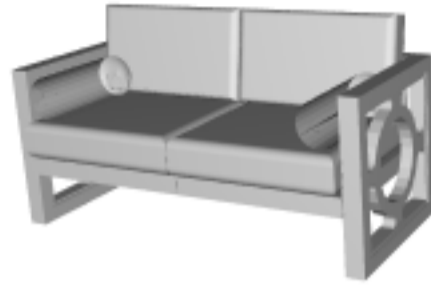

0.461538



0.384615

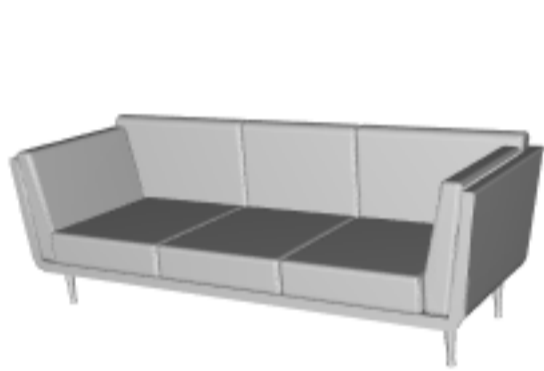

0.307692

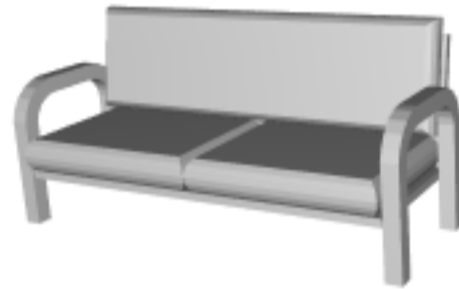

0.230769

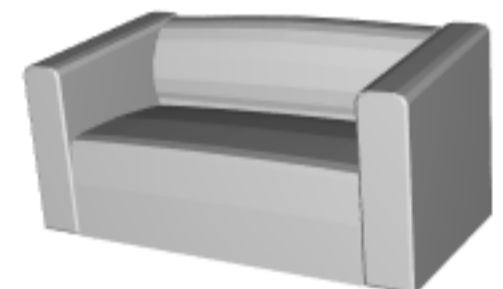

0.153846



Task 49 of 50 Score = 2.21088

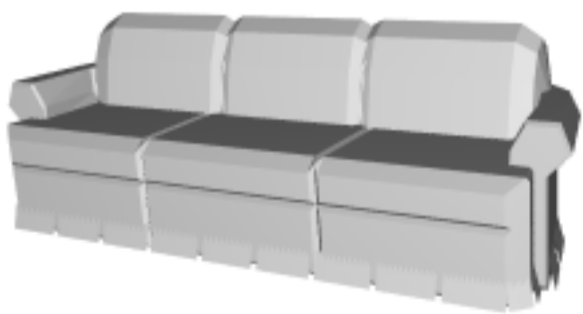

0.416667

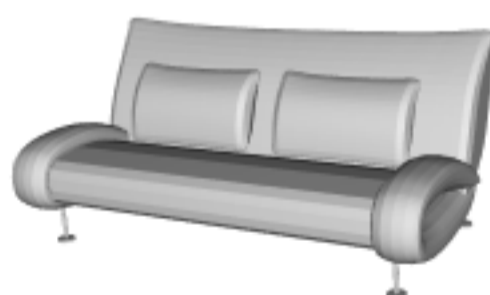

0.416667

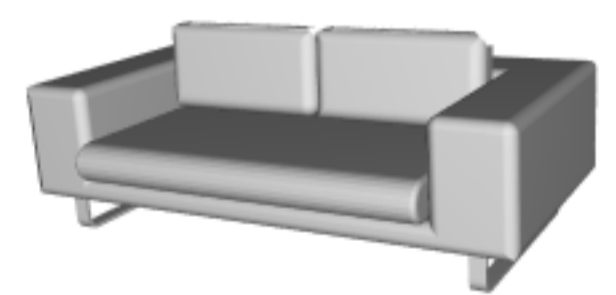

0.333333

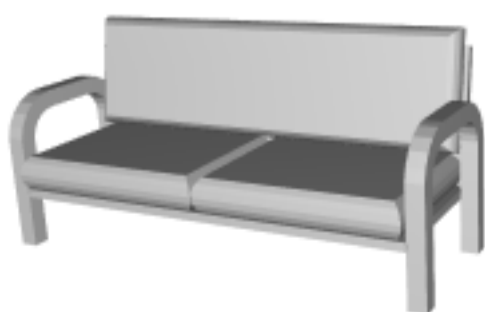

0.333333

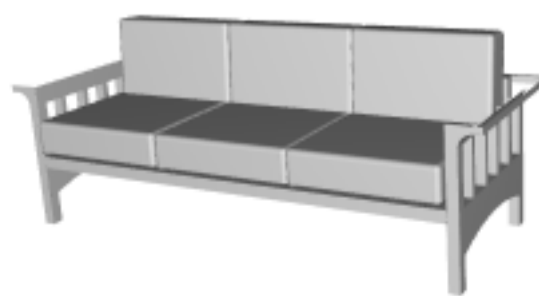

0.25



0.25



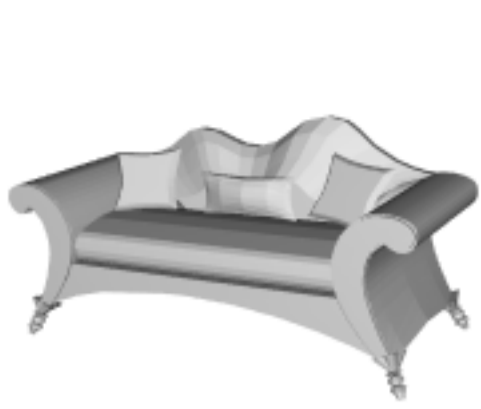

0.384615

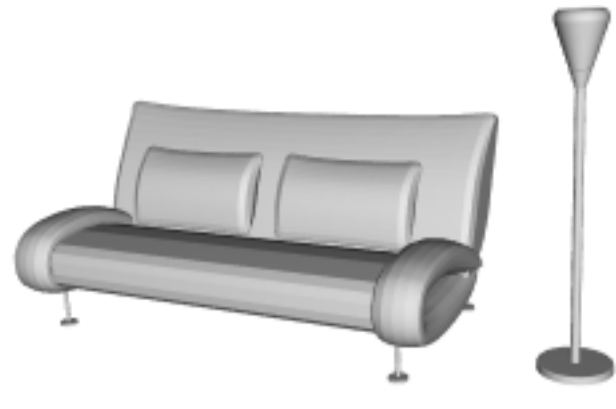

0.384615



0.384615

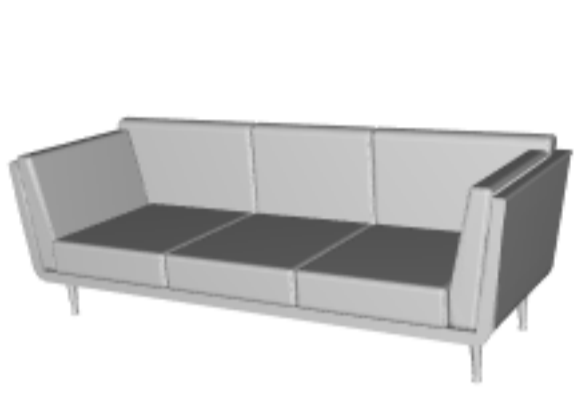

0.384615



0.307692



0.153846
